

Aug. 2009



# SERVICE MANUAL ADDENDUM

---

## IC-M801E

---

### CONTENTS

PARTS LIST .....	1
BOARD LAYOUTS .....	18
VOLTAGE DIAGRAM .....	20

# PARTS LIST

## [MAIN UNIT]

REF NO.	PARTS NO.	DESCRIPTION	M.	H/V LOCATION
IC1	1110006870	S.IC UPC2709TB-E3	T	191.6/133.5
IC501	1110005461	S.IC TA4107F(TE12L,F)	T	91.3/83
IC901	1110005461	S.IC TA4107F(TE12L,F)	T	78.2/83.2
IC1001	1130006221	S.IC TC4W53FU(TE12L,F)	T	77.6/55.9
IC1002	1110005450	S.IC TS522IDT	T	90.7/62.5
IC1051	1110005450	S.IC TS522IDT	T	74.2/45
IC1101	1110005450	S.IC TS522IDT	T	46.1/85.1
IC1201	1110005140	S.IC NJM3403AV-TE1-#ZZZB	T	118.2/115.7
IC1301	1160000131	S.IC TD62783AFG(5,S,EL)	T	98.7/118.2
IC1302	1160000131	S.IC TD62783AFG(5,S,EL)	T	166.8/94.5
IC1303	1160000131	S.IC TD62783AFG(5,S,EL)	T	57.9/109
IC1501	1180000421	S.IC TA78L05F(TE12R,F)	T	9/76.7
IC1502	1180002010	S.REG BA08FP-E2	T	152.4/116.6
IC1551	1110001401	S.IC UPC1555G2-E1-A	T	61/123.7
IC1601	1110003091	IC LA4425A-E		
IC1602	1130006221	S.IC TC4W53FU(TE12L,F)	T	21.7/25
IC1603	1110006300	S.IC NJM2172V-TE1-#ZZZB	T	29.1/37.1
IC1701	1130006221	S.IC TC4W53FU(TE12L,F)	T	25.6/58.3
IC1702	1110005450	S.IC TS522IDT	T	45.8/46.3
IC1703	1130006221	S.IC TC4W53FU(TE12L,F)	T	76.9/66.6
IC1704	1130006221	S.IC TC4W53FU(TE12L,F)	T	61.8/66.4
IC2001	1140013200	S.IC CD4053BPWR	T	61.3/48.5
IC2701	1110005461	S.IC TA4107F(TE12L,F)	T	40/60.9
IC2702	1110005450	S.IC TS522IDT	T	56.8/58.7
IC2703	1130006221	S.IC TC4W53FU(TE12L,F)	T	48.7/59.8
IC3101	1180000421	S.IC TA78L05F(TE12R,F)	T	140.1/26.9
IC3201	1130005721	S.IC TC7W04F(TE12L,F)	T	85.6/41.4
IC3301	1140009241	S.IC R1EX24128ASA00A	T	105.3/77.1
IC3302	1110005771	S.IC S-80942CNMC-G9CT2G	T	104/68.4
IC3303	1140013169	S.IC M30624FGPP(SX-1958A-9)	T	118.1/63.2
IC3601	1130007700	S.IC BU4094BCF-E2	T	95.8/27.9
IC3602	1130007700	S.IC BU4094BCF-E2	T	99.3/107.8
IC3603	1130007700	S.IC BU4094BCF-E2	T	86.5/48.6
IC3604	1130007700	S.IC BU4094BCF-E2	T	170/84
IC3605	1130007700	S.IC BU4094BCF-E2	T	68.6/108.8
IC3606	1110003690	S.IC M62354GP 75EC	T	67.3/94.2
IC3801	1130011551	S.IC RX-4581NB-F	T	135.8/55.6
IC9051	1120002921	S.IC ADM202EARNZ <FE>	T	172.2/16
IC9052	1130007041	S.IC TC7W32F(TE12L,F)	T	208.5/22.7
IC9053	1170000290	S.IC PS2701-1-F3	T	181.6/20.4
IC9054	1170000290	S.IC PS2701-1-F3	T	37.7/22.7
IC9055	1120003060	S.IC ADM4853ARZ-REEL7 <FE>	T	205.5/13
IC9101	1130006801	S.IC TC7W08F(TE12L,F)	T	51.2/14.9
IC9151	1130012940	S.IC TC74ACT245FT(EL)	T	238.8/15
IC9152	1130012950	S.IC TC74ACT04FT(EL)	T	256/14
Q51	1530003091	S.TRA 2SC4213-B(TE85R,F)	T	163.6/128.3
Q201	1560000721	S.FET 2SK2171-4-TD-E	T	184.4/78.3
Q202	1560000721	S.FET 2SK2171-4-TD-E	T	179.5/81.7
Q203	1580000620	S.FET 3SK131-T2 MAS	T	191.4/54.6
Q401	1580000620	S.FET 3SK131-T2 MAS	T	136.6/102.3
Q501	1580000620	S.FET 3SK131-T2 MAS	T	92.2/96.6
Q601	1530003151	S.TRA 2SC4673D-TD-E	T	201.4/77.5
Q701	1580000620	S.FET 3SK131-T2 MAS	T	204.6/100.4
Q702	1580000620	S.FET 3SK131-T2 MAS	T	212.8/77.5
Q703	1580000620	S.FET 3SK131-T2 MAS	T	207.9/77.5
Q801	1580000620	S.FET 3SK131-T2 MAS	T	132.9/92.7
Q1201	1590000680	S.TRA DTC114EUA T106	T	109.8/112.7
Q1202	1590000680	S.TRA DTC114EUA T106	T	109.8/115.3
Q1203	1510000771	S.TRA 2SA1586-GR(TE85L,F)	T	131.6/114.9
Q1204	1510000771	S.TRA 2SA1586-GR(TE85L,F)	T	138.9/122.3
Q1205	1530003091	S.TRA 2SC4213-B(TE85R,F)	T	136/123.5
Q1501	1540000441	S.TRA 2SD1619T-TD-E	T	83.7/113.3
Q1502	1540000441	S.TRA 2SD1619T-TD-E	T	85.5/120.7
Q1503	1590000680	S.TRA DTC114EUA T106	T	87.7/114.5
Q1504	1590000680	S.TRA DTC114EUA T106	T	88.4/124.5
Q1601	1590000680	S.TRA DTC114EUA T106	T	3.3/25.3
Q1801	1540000441	S.TRA 2SD1619T-TD-E	T	140.6/37.8
Q2101	1590000680	S.TRA DTC114EUA T106	T	41.6/133.4
Q2102	1530002691	S.TRA 2SC4116-GR(TE85R,F)	T	41.6/130.1
Q2301	1560000721	S.FET 2SK2171-4-TD-E	T	36.8/97
Q2302	1560000721	S.FET 2SK2171-4-TD-E	T	36.8/91
Q2401	1580000620	S.FET 3SK131-T2 MAS	T	35.6/79.3
Q2501	1580000620	S.FET 3SK131-T2 MAS	T	43.9/72.8
Q3001	1590000680	S.TRA DTC114EUA T106	T	134/125.8
Q3004	1530002691	S.TRA 2SC4116-GR(TE85R,F)	T	137.4/44.5
Q3801	1510000501	S.TRA 2SA1162-GR(TE85R,F)	T	134/49.1
Q3802	1530002691	S.TRA 2SC4116-GR(TE85R,F)	T	137.3/49.7
Q9001	1590000680	S.TRA DTC114EUA T106	T	127.5/19.7
Q9002	1590000680	S.TRA DTC114EUA T106	T	145.6/19.7
Q9051	1530002691	S.TRA 2SC4116-GR(TE85R,F)	T	163.9/9.2
Q9054	1590000680	S.TRA DTC114EUA T106	T	203.7/21.6
Q9055	1530002691	S.TRA 2SC4116-GR(TE85R,F)	T	163.9/6.6
Q9056	1530002691	S.TRA 2SC4116-GR(TE85R,F)	T	184/16.6
Q9057	1530002691	S.TRA 2SC4116-GR(TE85R,F)	T	30.9/22.4
D51	1750001360	S.DIO L709CER (9401)	T	170.3/132.7
D52	1750001360	S.DIO L709CER (9401)	T	173.1/132.7
D53	1790001770	S.DIO MA80WK-(TX)	T	182.1/133.7
D101	1790001770	S.DIO MA80WK-(TX)	T	171.9/125.1
D102	1790001770	S.DIO MA80WK-(TX)	T	181.6/125.8
D103	1790001770	S.DIO MA80WK-(TX)	T	189.7/125.7
D104	1790001770	S.DIO MA80WK-(TX)	T	204.7/125.8
D105	1790000620	S.DIO MA77(TX)	T	216.6/125.6
D106	1790001770	S.DIO MA80WK-(TX)	T	167.7/108.3
D107	1790001770	S.DIO MA80WK-(TX)	T	181.6/105.7

## [MAIN UNIT]

REF NO.	PARTS NO.	DESCRIPTION	M.	H/V LOCATION
D108	1790001770	S.DIO MA80WK-(TX)	T	192/106.7
D109	1790001770	S.DIO MA80WK-(TX)	T	206.2/106.7
D110	1790000620	S.DIO MA77(TX)	T	216.7/106.9
D201	1790001770	S.DIO MA80WK-(TX)	T	192.8/103.1
D301	1790001770	S.DIO MA80WK-(TX)	T	207.1/54.9
D302	1790000431	S.DIO HSB88WSTR-E	T	160/52.3
D303	1750001770	S.DIO MA80WK-(TX)	T	154.8/72.1
D401	1790000620	S.DIO MA77(TX)	T	127.1/97.2
D402	1790000620	S.DIO MA77(TX)	T	94.8/99.2
D403	1790001770	S.DIO MA77(TX)	T	124/89.9
D404	1790000620	S.DIO MA77(TX)	T	97.1/88.2
D601	1790002281	S.ZEN MAZ8091GML	T	193.4/76.8
D602	1790001770	S.DIO MA80WK-(TX)	T	193.1/72.4
D901	1790001770	S.DIO MA80WK-(TX)	T	82.8/74.5
D1102	1790001241	S.DIO MA2S7280GL	T	46.8/80
D1201	1790001241	S.DIO MA2S7280GL	T	112.6/110.1
D1202	1790001251	S.DIO MA2S1110GL	T	123.4/119.1
D1203	1790001251	S.DIO MA2S1110GL	T	123.5/120.4
D1204	1790001251	S.DIO MA2S1110GL	T	126.3/111.8
D1205	1790001251	S.DIO MA2S1110GL	T	127.7/114.2
D1206	1790000620	S.DIO MA77(TX)	T	139/111
D1207	1790001251	S.DIO MA2S1110GL	T	127.7/115.5
D1501	1790001670	S.DIO RB706F-40T106	T	83.2/117.5
D1502	1790001670	S.DIO RB706F-40T106	T	83.4/124.8
D1551	1730002321	S.ZEN MAZ8051GML	T	65.4/132.9
D1552	1790001670	S.DIO RB706F-40T106	T	70.8/128.5
D1554	1730002281	S.ZEN MAZ8091GML	T	57.2/128.2
D1601	1790001251	S.DIO MA2S1110GL	T	34.5/28.6
D1801	1790001251	S.DIO MA2S1110GL	T	137.5/42.6
D2101	1790001241	S.DIO MA2S7280GL	T	34.9/128.1
D2102	1790001251	S.DIO MA2S1110GL	T	32.1/133.6
D2103	1750001360	S.DIO L709CER (9401)	T	34.6/132.7
D2104	1750001360	S.DIO L709CER (9401)	T	37.4/132.7
D2201	1790001770	S.DIO MA80WK-(TX)	T	32.2/124.1
D2202	1790001770	S.DIO MA80WK-(TX)	T	12.2/124.1
D2203	1790001770	S.DIO MA80WK-(TX)	T	35.9/103.5
D2204	1790001770	S.DIO MA80WK-(TX)	T	13.5/103.6
D2301	1750000431	S.DIO HSB88WSTR-E	T	24.5/94.6
D3001	1790001670	S.DIO RB706F-40T106	T	105.6/83
D3002	1790001670	S.DIO RB706F-40T106	T	44.9/28.9
D3003	1790001670	S.DIO RB706F-40T106	T	44.9/32.7
D3004	1790001251	S.DIO MA2S1110GL	T	146.4/45.4
D3006	1790001670	S.DIO RB706F-40T106	T	113.9/101.9
D3007	1790001670	S.DIO RB706F-40T106	T	107.7/87.1
D3301	1790001251	S.DIO MA2S1110GL	T	110.9/48.6
D3302	1790001251	S.DIO MA2S1110GL	T	113.7/49.4
D3336	1790001251	S.DIO MA2S1110GL	T	107.3/45.9
D3337	1790001251	S.DIO MA2S1110GL	T	107.3/47.3
D3801	1790001251	S.DIO MA2S1110GL	T	153.5/31.6
D3802	1790001251	S.DIO MA2S1110GL	T	154.8/31.6
D3803	1790001251	S.DIO MA2S1110GL	T	156.1/31.6
D9001	1790001251	S.DIO MA2S1110GL	T	146.2/17
D9002	1790001251	S.DIO MA2S1110GL	T	128.1/17
D9003	1790001251	S.DIO MA2S1110GL	T	120/10.7
D9051	1790001251	S.DIO MA2S1110GL	T	183.7/24.8
D9052	1790001251	S.DIO MA2S1110GL	T	203.1/24.5
D9101	1790001251	S.DIO MA2S1110GL	T	30.2/24.7
D9102	1790001251	S.DIO MA2S1110GL	T	55.3/12.6
D9103	1790001670	S.DIO RB706F-40T106	T	249.6/15.7
D9104	1790001670	S.DIO RB706F-40T106	T	218.8/12.8
D9105	1790001670	S.DIO RB706F-40T106	T	224.3/12.8
FI201	2010002600	XTA 64M15A 64.455 MHz (FL-345)		
FI231	2010001880	MON HC-49/U 10.700 MHz (FL-231)		
FI301	2010002470	XTA 64M15B1 64.45500 MHz (FL-315)		
FI401	20200001960	CER CFWLB455KHFA-B0 (CFWMA455H)		
FI402	20200001330	CER CFWLA455KHFA-B0 (CFWMA455HT)		
X3301	6050010501	S.XTA CR-636A SMD-49 14.7456 MHz <KDS>	T	103.6/57.3
L1	6200002651	S.COI NLV25T-R18J	T	202.4/130.4
L2	6200010740	S.COI C2520C-R27G-A	T	197.9/130.5
L3	6200002861	S.COI NLV25T-4R7J	T	194.6/133.4
L51	6200002861	S.COI NLV25T-4R7J	T	176.2/134
L52	6200009881	S.COI NLV25T-820J	T	175.3/127.6
L53	6200004671	S.COI NLV25T-3R9J	T	179.6/133.4
L54	6200002041	S.COI NLV25T-101J	T	171.8/127.6
L55	6200002041	S.COI NLV25T-101J	T	182.9/131
L56	6200002041	S.COI NLV25T-101J	T	188.2/128.6
L101	6200003941	S.COI NLV25T-5R6J	T	160.3/118.5
L102	6200002861	S.COI NLV25T-4R7J	T	168.2/119.7
L103	6200002041	S.COI NLV25T-101J	T	167.6/122.5
L104	6200003281	S.COI NLV25T-2R2J	T	174.7/119.6
L105	6200002041	S.COI NLV25T-101J	T	174.1/122.5
L106	6200009861	S.COI NLV25T-1R5J	T	181.9/119.7
L107	6200002041	S.COI NLV25T-101J	T	181.1/122.5
L108	6200001981	S.COI NLV25T-1R0J	T	188.6/119.4
L109	6200002041	S.COI NLV25T-101J	T	188/122.4
L110	6200002851	S.COI NLV25T-R82J	T	195.4/119.6
L111	6200002041	S.COI NLV25T-101J	T	194.8/122.5
L112	6200003661	S.COI NLV25T-R68J	T	202.1/119.6
L113	6200002041	S.COI NLV25T-101J	T	201.6/123.3

M.=Mounted side (T: Mounted on the Top side, B: Mounted on the Bottom side)  
S.=Surface mount

[MAIN UNIT]

REF NO.	PARTS NO.	DESCRIPTION	M.	H/V LOCATION
L114	6200010960	S.COI C2520C-R47G-A (0.47U)	T	209.4/120.6
L115	6200002041	S.COI NLV25T-101J	T	208.6/123.7
L116	6200010870	S.COI C2520C-R33G-A (0.33U)	T	216.2/121
L117	6200002041	S.COI NLV25T-101J	T	214.1/124.3
L118	6200002861	S.COI NLV25T-4R7J	T	161.2/115.6
L119	6200002001	S.COI NLV25T-3R3J	T	167.7/116.9
L120	6200003281	S.COI NLV25T-2R2J	T	174.1/116.7
L121	6200009861	S.COI NLV25T-1R5J	T	181.3/116.8
L122	6200001981	S.COI NLV25T-1R0J	T	188/116.4
L123	6200003661	S.COI NLV25T-R68J	T	194.9/116.6
L124	6200002611	S.COI NLV25T-R47J	T	201.5/116.6
L125	6200011450	S.COI C2520C-R39G-A	T	208.6/117.1
L126	6200010740	S.COI C2520C-R27G-A	T	215.6/117.3
L127	6200002001	S.COI NLV25T-3R3J	T	165.8/113.8
L128	6200003281	S.COI NLV25T-2R2J	T	173.6/112.5
L129	6200003661	S.COI NLV25T-R68J	T	195.4/113.7
L130	6200002611	S.COI NLV25T-R47J	T	202.1/113.6
L131	6200011450	S.COI C2520C-R39G-A	T	208.4/113.5
L132	6200010740	S.COI C2520C-R27G-A	T	216.2/113.6
L133	6200003941	S.COI NLV25T-5R6J	T	166.1/111.1
L134	6200004951	S.COI NLV25T-1R8J	T	180.4/112.6
L135	6200001981	S.COI NLV25T-1R0J	T	188.6/113.4
L136	6200003661	S.COI NLV25T-R68J	T	194.2/110.8
L137	6200003271	S.COI NLV25T-R56J	T	200.3/110.3
L138	6200011450	S.COI C2520C-R39G-A	T	208/109.6
L139	6200010870	S.COI C2520C-R33G-A (0.33U)	T	214.5/109.9
L140	6200002041	S.COI NLV25T-101J	T	160.8/121.5
L141	6200004951	S.COI NLV25T-1R8J	T	174.3/109.5
L142	6200004741	S.COI NLV25T-1R2J	T	181.3/109.8
L143	6200002851	S.COI NLV25T-R82J	T	186.8/110
L144	6200002041	S.COI NLV25T-101J	T	161.9/107.8
L201	6200002041	S.COI NLV25T-101J	T	199.1/104.4
L202	6200010740	S.COI C2520C-R27G-A	T	190.9/100.2
L203	6200010740	S.COI C2520C-R27G-A	T	185.8/102.3
L204	6140003620	COI LR-403		
L205	6200002041	S.COI NLV25T-101J	T	216/55.9
L206	6200002631	S.COI NLV25T-R10J	T	183.3/83
L207	6150004270	COI LS-483A (C-14924)		
L208	6150005110	COI LS-540		
L209	6150005110	COI LS-540		
L210	6150004270	COI LS-483A (C-14924)		
L301	6150005110	COI LS-540		
L302	6150005110	COI LS-540		
L303	6140002810	S.COI LR-317	T	160/45.6
L304	6140003530	COI LR-395		
L305	6200005011	S.COI NLV25T-100J	T	161.5/68.1
L306	6200009871	S.COI NLV25T-120J	T	157.3/69.1
L307	6150005110	COI LS-540		
L401	6150005140	COI LS-542		
L402	6150005140	COI LS-542		
L403	6150002291	COI LS-450		
L404	6150005140	COI LS-542		
L405	6150005140	COI LS-542		
L406	6200003520	S.COI ELJFB 102K-F	T	128/92.3
L502	6200003520	S.COI ELJFB 102K-F	T	87.5/93.9
L504	6200002041	S.COI NLV25T-101J	T	94.1/88.9
L505	6200002041	S.COI NLV25T-101J	T	91.2/86
L506	6200003520	S.COI ELJFB 102K-F	T	87.7/88.4
L601	6200005011	S.COI NLV25T-100J	T	195.5/85.1
L602	6200002841	S.COI NLV25T-R22J	T	205.4/85.9
L603	6200003281	S.COI NLV25T-2R2J	T	196.9/77.8
L604	6200010870	S.COI C2520C-R33G-A (0.33U)	T	200/71.8
L605	6200002841	S.COI NLV25T-R22J	T	196.6/69.7
L701	6140002810	S.COI LR-317	T	198/100.6
L702	6200001981	S.COI NLV25T-1R0J	T	210.7/101.7
L703	6200003661	S.COI NLV25T-R68J	T	213.5/100.6
L704	6200002041	S.COI NLV25T-101J	T	212.5/84
L705	6200002041	S.COI NLV25T-101J	T	208.5/82.9
L706	6150004270	COI LS-483A (C-14924)		
L707	6140002810	S.COI LR-317	T	202.9/66
L801	6150004440	COI LS-495		
L901	6200002041	S.COI NLV25T-101J	T	85.1/83
L902	6200002041	S.COI NLV25T-101J	T	82.3/81.8
L903	6200002041	S.COI NLV25T-101J	T	82.4/85.7
L904	6200011520	S.COI SLF7045T-102MR14-PF	T	119.4/105.2
L1301	6200005491	S.COI NLV32T-331J	T	87.7/109.4
L1302	6200005491	S.COI NLV32T-331J	T	83.2/105.8
L1551	6180001000	COI LAL 02NA 102K		
L1552	6180001000	COI LAL 02NA 102K		
L1601	6180003640	COI SZW1012T-142-0.3		
L1602	6200002041	S.COI NLV25T-101J	T	22.7/54.6
L1901	6200002041	S.COI NLV25T-101J	T	122.6/128.7
L1902	6200002041	S.COI NLV25T-101J	T	128.6/129.1
L1903	6200002041	S.COI NLV25T-101J	T	143.5/128.1
L1904	6200003950	S.COI HF50ACC 322513-T	T	129.1/126.3
L1905	6200002041	S.COI NLV25T-101J	T	140.8/128.1
L1906	6140002220	COI LR-270 (TR6X3X2 3A9)		
L1907	6200003950	S.COI HF50ACC 322513-T	T	18.4/31.5
L1908	6200003950	S.COI HF50ACC 322513-T	T	125.4/128
L2051	6200002041	S.COI NLV25T-101J	T	48.7/19.2
L2052	6200002041	S.COI NLV25T-101J	T	60.9/29
L2053	6200002041	S.COI NLV25T-101J	T	63.4/29
L2054	6200002041	S.COI NLV25T-101J	T	58.4/29
L2055	6200011520	S.COI SLF7045T-102MR14-PF	T	51.5/33.1
L2056	6200003241	S.COI NLV32T-221J	T	51.8/26.7
L2057	6200003241	S.COI NLV32T-221J	T	48.8/26.7
L2058	6200011520	S.COI SLF7045T-102MR14-PF	T	59.4/34.5
L2101	6200002041	S.COI NLV25T-101J	T	35.4/124.9
L2201	6200003281	S.COI NLV25T-2R2J	T	36.2/121.9
L2202	6200002041	S.COI NLV25T-101J	T	39.2/122.9
L2204	6200002041	S.COI NLV25T-101J	T	28.7/122.6
L2205	6180001730	COI LAL 02NA 1R8K		
L2206	6200002041	S.COI NLV25T-101J	T	8.4/122.9
L2207	6200003711	S.COI NLV25T-2R7J	T	42.3/121
L2208	6200002611	S.COI NLV25T-R47J	T	28.3/119.8

[MAIN UNIT]

REF NO.	PARTS NO.	DESCRIPTION	M.	H/V LOCATION
L2209	6200007790	S.COI LQW2BHN15J03L	T	6.9/119.4
L2210	6200004951	S.COI NLV25T-1R8J	T	36.2/118.3
L2211	6180002380	COI LAL 02NA 2R2K		
L2212	6180001730	COI LAL 02NA 1R8K		
L2213	6200005031	S.COI NLV25T-180J	T	39.1/118
L2214	6200002001	S.COI NLV25T-3R3J	T	27.5/116.9
L2215	6200002851	S.COI NLV25T-R82J	T	6.4/115.1
L2216	6200003281	S.COI NLV25T-2R2J	T	38.5/115
L2217	6200003281	S.COI NLV25T-2R2J	T	27.5/113.9
L2218	6180002300	COI LAL 02NA 1R2K		
L2219	6200005041	S.COI NLV25T-220J	T	36.2/111.9
L2220	6200003711	S.COI NLV25T-2R7J	T	42.2/114.9
L2221	6180001210	COI LAL 03NA 8R2K		
L2222	6200010870	S.COI C2520C-R33G-A (0.33U)	T	32/114.2
L2223	6200004741	S.COI NLV25T-1R2J	T	3.9/109.2
L2224	6200007780	S.COI LQW2BHN12J03L	T	10.4/113.6
L2225	6200004741	S.COI NLV25T-1R2J	T	37.1/108.8
L2226	6200001981	S.COI NLV25T-1R0J	T	25.5/107.3
L2227	6200002611	S.COI NLV25T-R47J	T	4.5/105
L2228	6200002001	S.COI NLV25T-3R3J	T	42.4/110.7
L2229	6200002611	S.COI NLV25T-R47J	T	31.7/110.8
L2230	6200007780	S.COI LQW2BHN12J03L	T	9.9/108.7
L2231	6200002041	S.COI NLV25T-101J	T	43/106.8
L2232	6200002041	S.COI NLV25T-101J	T	29.7/105.4
L2233	6200002041	S.COI NLV25T-101J	T	9.1/103.9
L2235	6180000680	COI LAL 02NA 4R7K		
L2236	6200002041	S.COI NLV25T-101J	T	18/123.3
L2237	6200007760	S.COI LQW2BHN82NJ03L	T	17.7/119.9
L2238	6180002920	COI LAL 02NA 5R6K		
L2239	6200003661	S.COI NLV25T-R68J	T	17.2/117
L2240	6200003941	S.COI NLV25T-5R6J	T	17.1/113.9
L2241	6200001981	S.COI NLV25T-1R0J	T	14.7/110.9
L2242	6200007760	S.COI LQW2BHN82NJ03L	T	20/114
L2243	6200003271	S.COI NLV25T-R56J	T	16.3/107.8
L2244	6200007760	S.COI LQW2BHN82NJ03L	T	21.4/109.6
L2245	6200002041	S.COI NLV25T-101J	T	19/104.6
L2301	6200002041	S.COI NLV25T-101J	T	39.2/102.5
L2302	6140003660	COI LR-409		
L2304	6140003660	COI LR-409		
L2305	6200010740	S.COI C2520C-R27G-A	T	11.1/98.9
L2306	6150005150	COI LS-543		
L2307	6150005380	COI LS-552		
L2401	6200010221	S.COI NLV25T-560J	T	38.2/83.2
L2501	6200010221	S.COI NLV25T-560J	T	44.4/69.2
L2701	6200003520	S.COI ELJFB 102K-F	T	33.9/60.8
L2702	6200003520	S.COI ELJFB 102K-F	T	35.7/57.1
L2703	6200002041	S.COI NLV25T-101J	T	31.9/63.9
L3301	6200001831	S.COI NLV32T-100J	T	128.6/24.8
L3601	6200003950	S.COI HF50ACC 322513-T	T	66.2/32.1
L3602	6200003950	S.COI HF50ACC 322513-T	T	69.8/34
L9001	6200002041	S.COI NLV25T-101J	T	150.9/23.2
L9002	6200003950	S.COI HF50ACC 322513-T	T	155.9/23.8
L9151	6200005011	S.COI NLV25T-100J	T	233.2/19.1
L9152	6200005011	S.COI NLV25T-100J	T	252.7/18
L9153	6200002041	S.COI NLV25T-101J	T	165.8/19.6
L9154	6200005011	S.COI NLV25T-100J	T	211.2/11.8
R1	7030003240	S.RES ERJ3GEYJ 220 V (22)	T	209.1/128.8
R2	7030003340	S.RES ERJ3GEYJ 151 V (150)	T	209.1/130.1
R3	7030003340	S.RES ERJ3GEYJ 151 V (150)	T	206.4/130.1
R4	7030003280	S.RES ERJ3GEYJ 470 V (47)	T	194.4/131.1
R5	7030003230	S.RES ERJ3GEYJ 180 V (18)	T	188.5/132
R6	7030003370	S.RES ERJ3GEYJ 271 V (270)	T	189.3/133.8
R7	7030003370	S.RES ERJ3GEYJ 271 V (270)	T	187.9/133.8
R8	7030003400	S.RES ERJ3GEYJ 471 V (470)	T	185.3/133.8
R9	7030003230	S.RES ERJ3GEYJ 180 V (18)	T	206.4/128.8
R10	7030003240	S.RES ERJ3GEYJ 220 V (22)	T	194.4/129.8
R54	7030003410	S.RES ERJ3GEYJ 561 V (560)	T	179.7/129.5
R56	7030003360	S.RES ERJ3GEYJ 221 V (220)	T	179.7/128
R57	7030003400	S.RES ERJ3GEYJ 471 V (470)	T	183.3/129.1
R58	7030003400	S.RES ERJ3GEYJ 471 V (470)	T	185.3/128.6
R59	7030003440	S.RES ERJ3GEYJ 102 V (1K)	T	166.5/125.9
R60	7030003440	S.RES ERJ3GEYJ 102 V (1K)	T	163.9/125.1
R61	7030003560	S.RES ERJ3GEYJ 103 V (10K)	T	165.8/127.9
R101	7030003360	S.RES ERJ3GEYJ 221 V (220)	T	163.8/111.2
R102	7030003360	S.RES ERJ3GEYJ 221 V (220)	T	173.8/107.6
R103	7030003360	S.RES ERJ3GEYJ 221 V (220)	T	180.6/107.9
R104	7030003360	S.RES ERJ3GEYJ 221 V (220)	T	186.1/108.1
R105	7030003360	S.RES ERJ3GEYJ 221 V (220)	T	194.4/108.9
R106	7030003360	S.RES ERJ3GEYJ 221 V (220)	T	200.1/108.4
R107	7030003360	S.RES ERJ3GEYJ 221 V (220)	T	205.3/111.1
R108	7030003360	S.RES ERJ3GEYJ 221 V (220)	T	213.7/107.6
R109	7030003360	S.RES ERJ3GEYJ 221 V (220)	T	160.5/112.5
R110	7030003400	S.RES ERJ3GEYJ 471 V (470)	T	164.6/106.8
R201	7030003400	S.RES ERJ3GEYJ 471 V (470)	T	195.6/104.2
R202	7030003360	S.RES		

[MAIN UNIT]

REF NO.	PARTS NO.	DESCRIPTION	M.	H/V LOCATION
R401	7030003440	S.RES ERJ3GEYJ 102 V (1K)	T	160.3/704.6
R404	7030003640	S.RES ERJ3GEYJ 473 V (47K)	T	147.3/102.1
R405	7030003560	S.RES ERJ3GEYJ 103 V (10K)	T	139.5/100.6
R406	7030003760	S.RES ERJ3GEYJ 474 V (470K)	T	136.6/106
R407	7030003320	S.RES ERJ3GEYJ 101 V (100)	T	136.9/98.6
R408	7030003400	S.RES ERJ3GEYJ 471 V (470)	T	134.2/104
R409	7030003320	S.RES ERJ3GEYJ 101 V (100)	T	140/105.3
R410	7030003440	S.RES ERJ3GEYJ 102 V (1K)	T	118.8/100.3
R413	7030003440	S.RES ERJ3GEYJ 102 V (1K)	T	104.9/101.1
R414	7030003440	S.RES ERJ3GEYJ 102 V (1K)	T	128.9/97.1
R415	7030003480	S.RES ERJ3GEYJ 222 V (2.2K)	T	89.1/107.2
R501	7030003860	S.RES ERJ3GE JPW V	T	85.6/102.4
R502	7030005871	S.RES ERA3YKD 104V (100K)	T	89/96.4
R503	7030003610	S.RES ERJ3GEYJ 273 V (27K)	T	88.9/97.7
R504	7030003440	S.RES ERJ3GEYJ 102 V (1K)	T	89/99
R505	7030003430	S.RES ERJ3GEYJ 821 V (820)	T	95.2/94.1
R506	7030003400	S.RES ERJ3GEYJ 471 V (470)	T	91.2/93.3
R507	7030003320	S.RES ERJ3GEYJ 101 V (100)	T	85.6/97
R508	7510001451	S.THE NTCG16 4BH 472JT	T	95.2/95.4
R509	7030003600	S.RES ERJ3GEYJ 223 V (22K)	T	86.9/97
R514	7030003440	S.RES ERJ3GEYJ 102 V (1K)	T	91.2/87.9
R601	7030006220	S.RES ERJ12YJ470U (47)	T	194.5/81.5
R602	7030003280	S.RES ERJ3GEYJ 470 V (47)	T	202.2/83.8
R603	7030009591	S.RES ERA3YED 472V (4.7K)	T	199.4/81.3
R604	7030003440	S.RES ERJ3GEYJ 102 V (1K)	T	202/81.3
R605	7030003200	S.RES ERJ3GEYJ 100 V (10)	T	198.2/75.3
R606	7030003440	S.RES ERJ3GEYJ 102 V (1K)	T	194.1/74.4
R607	7030003440	S.RES ERJ3GEYJ 102 V (1K)	T	191.2/73.1
R608	7030003400	S.RES ERJ3GEYJ 471 V (470)	T	203.3/81.3
R609	7030003440	S.RES ERJ3GEYJ 102 V (1K)	T	198.1/81.3
R610	7030003200	S.RES ERJ3GEYJ 100 V (10)	T	201.4/85.7
R701	7030003360	S.RES ERJ3GEYJ 221 V (220)	T	202.2/100.6
R702	7030003410	S.RES ERJ3GEYJ 561 V (560)	T	202.3/97.2
R703	7030003440	S.RES ERJ3GEYJ 102 V (1K)	T	207/103.2
R704	7030003640	S.RES ERJ3GEYJ 473 V (47K)	T	204.9/102.8
R705	7030003360	S.RES ERJ3GEYJ 221 V (220)	T	205.7/97.3
R706	7030003320	S.RES ERJ3GEYJ 101 V (100)	T	207.7/100.7
R707	7510001461	S.THE NTCG16 3NH 471JT	T	207.7/99.4
R708	7030003440	S.RES ERJ3GEYJ 102 V (1K)	T	215.2/77.2
R709	7030003440	S.RES ERJ3GEYJ 102 V (1K)	T	210.4/77.2
R710	7030003360	S.RES ERJ3GEYJ 221 V (220)	T	211.4/81.3
R711	7030003400	S.RES ERJ3GEYJ 471 V (470)	T	210.2/75
R712	7030003370	S.RES ERJ3GEYJ 271 V (270)	T	210/64.4
R713	7030003230	S.RES ERJ3GEYJ 180 V (18)	T	194.2/64
R714	7030003370	S.RES ERJ3GEYJ 271 V (270)	T	192.2/63.2
R715	7030003230	S.RES ERJ3GEYJ 180 V (18)	T	210/63.1
R716	7030003370	S.RES ERJ3GEYJ 271 V (270)	T	207.6/63.6
R717	7030003370	S.RES ERJ3GEYJ 271 V (270)	T	192.2/64.8
R718	7030003440	S.RES ERJ3GEYJ 102 V (1K)	T	193.2/70.3
R719	7030003320	S.RES ERJ3GEYJ 101 V (100)	T	198.7/97.3
R720	7030003550	S.RES ERJ3GEYJ 822 V (8.2K)	T	199/65.1
R722	7510001461	S.THE NTCG16 3NH 471JT	T	203.6/97.4
R801	7030003480	S.RES ERJ3GEYJ 222 V (2.2K)	T	136.3/93
R802	7030003240	S.RES ERJ3GEYJ 220 V (22)	T	131.5/97.1
R803	7030003860	S.RES ERJ3GE JPW V	T	133.8/95.1
R804	7030003400	S.RES ERJ3GEYJ 471 V (470)	T	130.6/90.3
R813	7030003600	S.RES ERJ3GEYJ 223 V (22K)	T	131.2/95.1
R901	7030003440	S.RES ERJ3GEYJ 102 V (1K)	T	80.3/73.7
R902	7030003440	S.RES ERJ3GEYJ 102 V (1K)	T	82.5/78.4
R903	7030003440	S.RES ERJ3GEYJ 102 V (1K)	T	85.7/74.1
R904	7030003280	S.RES ERJ3GEYJ 470 V (47)	T	82.4/83.8
R910	7030003440	S.RES ERJ3GEYJ 102 V (1K)	T	82.8/79.9
R911	7030003440	S.RES ERJ3GEYJ 102 V (1K)	T	84.1/89.4
R1002	7030003400	S.RES ERJ3GEYJ 471 V (470)	T	74.4/58.3
R1003	7030003400	S.RES ERJ3GEYJ 471 V (470)	T	79.5/63.8
R1004	7030003440	S.RES ERJ3GEYJ 102 V (1K)	T	75.7/52.6
R1005	7030003440	S.RES ERJ3GEYJ 102 V (1K)	T	80.1/52.7
R1006	7030003440	S.RES ERJ3GEYJ 102 V (1K)	T	81/62.1
R1007	7030003440	S.RES ERJ3GEYJ 102 V (1K)	T	82.3/62.1
R1008	7030003320	S.RES ERJ3GEYJ 101 V (100)	T	85.8/61.9
R1009	7030003320	S.RES ERJ3GEYJ 101 V (100)	T	87.2/67.6
R1010	7030003440	S.RES ERJ3GEYJ 102 V (1K)	T	85.5/65
R1011	7030003440	S.RES ERJ3GEYJ 102 V (1K)	T	91.9/66.7
R1012	7030003860	S.RES ERJ3GE JPW V	T	93.9/66
R1014	7030003440	S.RES ERJ3GEYJ 102 V (1K)	T	92.6/68.6
R1015	7030003650	S.RES ERJ3GEYJ 563 V (56K)	T	89.2/66.7
R1016	7030003560	S.RES ERJ3GEYJ 103 V (10K)	T	91.1/68.6
R1017	7030003440	S.RES ERJ3GEYJ 102 V (1K)	T	81.7/56
R1018	7030003320	S.RES ERJ3GEYJ 101 V (100)	T	72.2/51.4
R1051	7030003320	S.RES ERJ3GEYJ 101 V (100)	T	70.8/51.4
R1052	7030003320	S.RES ERJ3GEYJ 101 V (100)	T	78.4/43.9
R1053	7030003440	S.RES ERJ3GEYJ 102 V (1K)	T	76.1/50
R1054	7030003440	S.RES ERJ3GEYJ 102 V (1K)	T	79.4/50.8
R1055	7030003440	S.RES ERJ3GEYJ 102 V (1K)	T	77.6/46.2
R1057	7030003440	S.RES ERJ3GEYJ 102 V (1K)	T	69.4/44.1
R1058	7030003440	S.RES ERJ3GEYJ 102 V (1K)	T	70.7/41.4
R1059	7030003440	S.RES ERJ3GEYJ 102 V (1K)	T	74.7/40
R1060	7030005871	S.RES ERA3YKD 104V (100K)	T	70.7/46.7
R1101	7030005871	S.RES ERA3YKD 104V (100K)	T	50.2/84.6
R1102	7030009591	S.RES ERA3YED 472V (4.7K)	T	50.7/80
R1103	7030005871	S.RES ERA3YKD 104V (100K)	T	50.2/85.9
R1104	7030003800	S.RES ERJ3GEYJ 105 V (1M)	T	48.8/89.9
R1105	7030003500	S.RES ERJ3GEYJ 332 V (3.3K)	T	45.5/80
R1106	7030003720	S.RES ERJ3GEYJ 224 V (220K)	T	50.2/88.6
R1107	7030003800	S.RES ERJ3GEYJ 105 V (1M)	T	44/80
R1108	7030003800	S.RES ERJ3GEYJ 105 V (1M)	T	46.2/89.6
R1109	7030003320	S.RES ERJ3GEYJ 101 V (100)	T	43.5/89.9
R1110	7030003320	S.RES ERJ3GEYJ 101 V (100)	T	50.2/87
R1111	7030003560	S.RES ERJ3GEYJ 103 V (10K)	T	50.2/83.3
R1112	7030003560	S.RES ERJ3GEYJ 103 V (10K)	T	50.2/87.2
R1113	7030003320	S.RES ERJ3GEYJ 101 V (100)	T	42.6/81.9
R1114	7030003320	S.RES ERJ3GEYJ 101 V (100)	T	42.6/84.6
R1115	7030003860	S.RES ERJ3GE JPW V	T	153.5/52.2
R1116	7030003860	S.RES ERJ3GE JPW V	T	153.5/53.5
R1118	7030003640	S.RES ERJ3GEYJ 473 V (47K)	T	51.5/89.9

[MAIN UNIT]

REF NO.	PARTS NO.	DESCRIPTION	M.	H/V LOCATION
R1201	7030003760	S.RES ERJ3GEYJ 474 V (470K)	T	109.9/110.8
R1202	7030003760	S.RES ERJ3GEYJ 474 V (470K)	T	110.5/120.2
R1203	7030003760	S.RES ERJ3GEYJ 474 V (470K)	T	112.7/114.5
R1204	7030003760	S.RES ERJ3GEYJ 474 V (470K)	T	112.7/113.2
R1205	7030005871	S.RES ERA3YKD 104V (100K)	T	114.8/110.4
R1206	7030003760	S.RES ERJ3GEYJ 474 V (470K)	T	115.4/112.2
R1207	7030003560	S.RES ERJ3GEYJ 103 V (10K)	T	128.1/118.1
R1208	7030003560	S.RES ERJ3GEYJ 103 V (10K)	T	123.6/116.5
R1209	7030003640	S.RES ERJ3GEYJ 473 V (47K)	T	123.7/122.2
R1210	7030003640	S.RES ERJ3GEYJ 473 V (47K)	T	109/119.2
R1211	7030005871	S.RES ERA3YKD 104V (100K)	T	124.4/113.9
R1212	7030005871	S.RES ERA3YKD 104V (100K)	T	127.4/116.8
R1213	7030005871	S.RES ERA3YKD 104V (100K)	T	112.7/117.1
R1214	7030003760	S.RES ERJ3GEYJ 474 V (470K)	T	112.7/115.8
R1215	7030003640	S.RES ERJ3GEYJ 473 V (47K)	T	123.4/117.8
R1216	7030003640	S.RES ERJ3GEYJ 473 V (47K)	T	120.9/120.4
R1217	7030003720	S.RES ERJ3GEYJ 224 V (220K)	T	118.4/111.7
R1218	7030003670	S.RES ERJ3GEYJ 823 V (82K)	T	117.3/119.6
R1219	7030003720	S.RES ERJ3GEYJ 224 V (220K)	T	122.6/113.3
R1220	7030003840	S.RES ERJ3GEYJ 225 V (2.2M)	T	120.9/119.1
R1221	7030003840	S.RES ERJ3GEYJ 225 V (2.2M)	T	115.3/119.1
R1222	7030003370	S.RES ERJ3GEYJ 271 V (270)	T	123.7/111.5
R1223	7030003480	S.RES ERJ3GEYJ 222 V (2.2K)	T	137/111.9
R1224	7030003320	S.RES ERJ3GEYJ 101 V (100)	T	118.6/119.6
R1225	7030003320	S.RES ERJ3GEYJ 101 V (100)	T	117.1/110.4
R1226	7030003360	S.RES ERJ3GEYJ 221 V (220)	T	131.9/117.4
R1227	7030003860	S.RES ERJ3GE JPW V	T	133.9/117
R1228	7030003440	S.RES ERJ3GEYJ 102 V (1K)	T	136.1/121.6
R1230	7030003760	S.RES ERJ3GEYJ 474 V (470K)	T	136.3/90.4
R1231	7030003860	S.RES ERJ3GE JPW V	T	115.7/121.9
R1232	7030009930	S.RES ERJ3GEYJ 825 V (8.2M)	T	125.2/118.9
R1233	7030003760	S.RES ERJ3GEYJ 474 V (470K)	T	112.5/111.9
R1234	7030003560	S.RES ERJ3GEYJ 103 V (10K)	T	140.9/122.3
R1235	7030003560	S.RES ERJ3GEYJ 103 V (10K)	T	142.7/121.5
R1240	7030003440	S.RES ERJ3GEYJ 102 V (1K)	T	112.5/119.7
R1241	7030003720	S.RES ERJ3GEYJ 224 V (220K)	T	123.3/115.2
R1242	7030005871	S.RES ERA3YKD 104V (100K)	T	109.9/117.2
R1250	7010006930	RES PSD1/4 470	T	127.1/119.6
R1301	7030003200	S.RES ERJ3GEYJ 100 V (10)	T	94.3/125.4
R1302	7030003200	S.RES ERJ3GEYJ 100 V (10)	T	96.5/125.4
R1303	7030003200	S.RES ERJ3GEYJ 100 V (10)	T	95.9/125.4
R1304	7030003200	S.RES ERJ3GEYJ 100 V (10)	T	98.2/125.4
R1305	7030003200	S.RES ERJ3GEYJ 100 V (10)	T	99.5/125.4
R1306	7030003200	S.RES ERJ3GEYJ 100 V (10)	T	100.8/125.4
R1307	7030003200	S.RES ERJ3GEYJ 100 V (10)	T	102.1/125.4
R1308	7030003200	S.RES ERJ3GEYJ 100 V (10)	T	103.4/125.4
R1309	7030004040	S.RES ERJ3GEYJ 477 V (4.7)	T	91.5/116.2
R1310	7030003500	S.RES ERJ3GEYJ 332 V (3.3K)	T	161.6/103.7
R1311	7030003500	S.RES ERJ3GEYJ 332 V (3.3K)	T	162.9/103.7
R1312	7030003500	S.RES ERJ3GEYJ 332 V (3.3K)	T	164.2/103.7
R1313	7030003500	S.RES ERJ3GEYJ 332 V (3.3K)	T	165.5/103.7
R1314	7030003500	S.RES ERJ3GEYJ 332 V (3.3K)	T	166.8/103.7
R1315	7030003500	S.RES ERJ3GEYJ 332 V (3.3K)	T	168.1/103.7
R1316	7030003500	S.RES ERJ3GEYJ 332 V (3.3K)	T	169.4/103.7
R1317	7030003500	S.RES ERJ3GEYJ 332 V (3.3K)	T	170.7/103.7
R1318	7030004040	S.RES ERJ3GEYJ 477 V (4.7)	T	174.3/90.6
R1319	7030004040	S.RES ERJ3GEYJ 477 V (4.7)	T	53.8/98.9
R1320	7030003500	S.RES ERJ3GEYJ 332 V (3.3K)	T	50.7/111.5
R1501	7030010420	S.RES ERJ1TYJ 560U (56)	T	4/78.4
R1502	7030004040	S.RES ERJ3GEYJ 477 V (4.7)	T	89.5/118.1
R1503	7030004040	S.RES ERJ3GEYJ 477 V (4.7)	T	89.5/119.4
R1504	7030003440	S.RES ERJ3GEYJ 102 V (1K)	T	87.4/112.6
R1505	7030003440	S.RES ERJ3GEYJ 102 V (1K)	T	88.7/121.5
R1506	7030009620	S.RES ERJ12YJ120U (12)	T	146.2/109.5
R1507	7030009620	S.RES ERJ12YJ120U (12)	T	146.2/113.2
R1551	7030006220	S.RES ERJ12YJ470U (47)	T	75.1/128.9
R1553	7030006220	S.RES ERJ12YJ470U (47)	T	55.6/131.1
R1555	7030003560	S.RES ERJ3GEYJ 103 V (10K)	T	59.9/130.3
R1556	7030003720	S.RES ERJ3GEYJ 224 V (220K)	T	61.3/129
R1601	7030003400	S.RES ERJ3GEYJ 471 V (470)	T	14.9/32.4
R1602	7030003440	S.RES ERJ3GEYJ 102 V (1K)	T	17.3/25.4

[MAIN UNIT]

REF NO.	PARTS NO.	DESCRIPTION	M.	H/V LOCATION
R1717	7030003440	S.RES ERJ3GEYJ 102 V (1K)	T	46.5/41.3
R1718	7030003560	S.RES ERJ3GEYJ 103 V (10K)	T	44.5/39.4
R1719	7030003560	S.RES ERJ3GEYJ 103 V (10K)	T	79.3/66.6
R1720	7030003400	S.RES ERJ3GEYJ 471 V (470)	T	75.4/70.8
R1721	7030003400	S.RES ERJ3GEYJ 471 V (470)	T	75.3/62.1
R1722	7030003440	S.RES ERJ3GEYJ 102 V (1K)	T	75.3/63.4
R1723	7030003440	S.RES ERJ3GEYJ 102 V (1K)	T	74.5/65.4
R1724	7030003400	S.RES ERJ3GEYJ 471 V (470)	T	58.9/69.1
R1725	7030003400	S.RES ERJ3GEYJ 471 V (470)	T	60.4/71
R1726	7030009591	S.RES ERA3YED 472V (4.7K)	T	26.6/53.7
R1801	7030003500	S.RES ERJ3GEYJ 332 V (3.3K)	T	143.8/36.4
R1802	7030003500	S.RES ERJ3GEYJ 332 V (3.3K)	T	145.1/36.4
R1803	7030003500	S.RES ERJ3GEYJ 332 V (3.3K)	T	146.4/36.7
R1804	7030003560	S.RES ERJ3GEYJ 103 V (10K)	T	145.1/39.1
R1901	7030004040	S.RES ERJ3GEYJ 4R7 V (4.7)	T	135/128.5
R1902	7030003440	S.RES ERJ3GEYJ 102 V (1K)	T	138.4/126.6
R1903	7030003440	S.RES ERJ3GEYJ 102 V (1K)	T	121.1/132.9
R1904	7030003440	S.RES ERJ3GEYJ 102 V (1K)	T	132.9/129.3
R2001	7030003560	S.RES ERJ3GEYJ 103 V (10K)	T	63.2/45
R2002	7030003560	S.RES ERJ3GEYJ 103 V (10K)	T	63.8/52.7
R2004	7030003860	S.RES ERJ3GE JPW V	T	62.5/52.7
R2005	7030003860	S.RES ERJ3GE JPW V	T	64.4/43
R2101	7030003600	S.RES ERJ3GEYJ 223 V (22K)	T	37.1/127.3
R2102	7030003560	S.RES ERJ3GEYJ 103 V (10K)	T	42.7/127.5
R2103	7030003320	S.RES ERJ3GEYJ 101 V (100)	T	43.9/133.6
R2104	7030003560	S.RES ERJ3GEYJ 103 V (10K)	T	45.4/130.9
R2105	7030003400	S.RES ERJ3GEYJ 471 V (470)	T	38.4/124.9
R2106	7030003630	S.RES ERJ3GEYJ 393 V (39K)	T	20/126.5
R2107	7030003630	S.RES ERJ3GEYJ 393 V (39K)	T	17.4/126.5
R2108	7030003600	S.RES ERJ3GEYJ 223 V (22K)	T	45.4/133.6
R2201	7030003320	S.RES ERJ3GEYJ 101 V (100)	T	50.7/105
R2202	7030003320	S.RES ERJ3GEYJ 101 V (100)	T	50.7/103.7
R2203	7030003320	S.RES ERJ3GEYJ 101 V (100)	T	50.7/106.3
R2204	7030003320	S.RES ERJ3GEYJ 101 V (100)	T	50.7/107.6
R2205	7030003500	S.RES ERJ3GEYJ 332 V (3.3K)	T	42.9/103
R2206	7030003500	S.RES ERJ3GEYJ 332 V (3.3K)	T	48/103.1
R2207	7030003500	S.RES ERJ3GEYJ 332 V (3.3K)	T	46.9/108.1
R2208	7030003500	S.RES ERJ3GEYJ 332 V (3.3K)	T	46.9/106.7
R2301	7030003440	S.RES ERJ3GEYJ 102 V (1K)	T	39.5/104.5
R2302	7030003240	S.RES ERJ3GEYJ 220 V (22)	T	43.4/92.1
R2303	7030004040	S.RES ERJ3GEYJ 4R7 V (4.7)	T	32.5/100
R2306	7030003280	S.RES ERJ3GEYJ 470 V (47)	T	10.9/96.2
R2401	7030003650	S.RES ERJ3GEYJ 563 V (56K)	T	32/82.2
R2402	7030003580	S.RES ERJ3GEYJ 153 V (15K)	T	33.3/82.5
R2403	7030003800	S.RES ERJ3GEYJ 105 V (1M)	T	35.3/76.9
R2404	7030003320	S.RES ERJ3GEYJ 101 V (100)	T	35.4/83.2
R2405	7030003320	S.RES ERJ3GEYJ 101 V (100)	T	40.6/85.4
R2406	7030003480	S.RES ERJ3GEYJ 222 V (2.2K)	T	39.2/79.1
R2407	7030005691	S.RES ERA3YED 123V (12K)	T	32/85.2
R2501	7030009591	S.RES ERA3YED 472V (4.7K)	T	47.8/76.4
R2502	7030003440	S.RES ERJ3GEYJ 102 V (1K)	T	47.8/73.8
R2503	7030003760	S.RES ERJ3GEYJ 474 V (470K)	T	39.2/76.7
R2504	7030003320	S.RES ERJ3GEYJ 101 V (100)	T	48.4/70.4
R2505	7030003320	S.RES ERJ3GEYJ 101 V (100)	T	47.8/65.6
R2506	7030003400	S.RES ERJ3GEYJ 471 V (470)	T	45.1/65.6
R2507	7030003400	S.RES ERJ3GEYJ 471 V (470)	T	47.8/72.5
R2508	7030003480	S.RES ERJ3GEYJ 222 V (2.2K)	T	47.8/75.1
R2701	7030003440	S.RES ERJ3GEYJ 102 V (1K)	T	35/63.4
R2702	7030003650	S.RES ERJ3GEYJ 563 V (56K)	T	51.8/58.1
R2703	7030003560	S.RES ERJ3GEYJ 103 V (10K)	T	49.4/54.9
R2704	7030003650	S.RES ERJ3GEYJ 563 V (56K)	T	51.8/59.4
R2705	7030003650	S.RES ERJ3GEYJ 563 V (56K)	T	51.8/60.7
R2706	7030003370	S.RES ERJ3GEYJ 271 V (270)	T	45/55.9
R2708	7030003440	S.RES ERJ3GEYJ 102 V (1K)	T	53.6/62.2
R2709	7030003320	S.RES ERJ3GEYJ 101 V (100)	T	56.3/63.5
R2710	7030003320	S.RES ERJ3GEYJ 101 V (100)	T	53.5/54.6
R2711	7030003440	S.RES ERJ3GEYJ 102 V (1K)	T	56.3/62.2
R2712	7030003440	S.RES ERJ3GEYJ 102 V (1K)	T	61.2/56.2
R2713	7030003440	S.RES ERJ3GEYJ 102 V (1K)	T	64.2/61
R2714	7030003440	S.RES ERJ3GEYJ 102 V (1K)	T	62.5/61.6
R2715	7030003230	S.RES ERJ3GEYJ 180 V (18)	T	43.1/55.1
R2716	7030003370	S.RES ERJ3GEYJ 271 V (270)	T	43.1/56.4
R2717	7030003400	S.RES ERJ3GEYJ 471 V (470)	T	46.3/61.2
R2718	7030003400	S.RES ERJ3GEYJ 471 V (470)	T	45/61.2
R3001	7030003440	S.RES ERJ3GEYJ 102 V (1K)	T	117.4/87
R3002	7030003440	S.RES ERJ3GEYJ 102 V (1K)	T	113.5/87
R3003	7030003360	S.RES ERJ3GEYJ 221 V (220)	T	108.4/82.8
R3004	7030003360	S.RES ERJ3GEYJ 221 V (220)	T	110.1/82.8
R3005	7030003400	S.RES ERJ3GEYJ 471 V (470)	T	117.8/84.9
R3006	7030003440	S.RES ERJ3GEYJ 102 V (1K)	T	126.8/49.1
R3007	7030003440	S.RES ERJ3GEYJ 102 V (1K)	T	112.3/82.8
R3008	7030003440	S.RES ERJ3GEYJ 102 V (1K)	T	113.8/83.1
R3009	7030003440	S.RES ERJ3GEYJ 102 V (1K)	T	115.1/83
R3010	7030003440	S.RES ERJ3GEYJ 102 V (1K)	T	114/103.9
R3011	7030003440	S.RES ERJ3GEYJ 102 V (1K)	T	119.3/82.9
R3012	7030003440	S.RES ERJ3GEYJ 102 V (1K)	T	33.6/48.2
R3013	7030003560	S.RES ERJ3GEYJ 103 V (10K)	T	104.5/87
R3014	7030003800	S.RES ERJ3GEYJ 105 V (1M)	T	97.7/74.4
R3015	7030003560	S.RES ERJ3GEYJ 103 V (10K)	T	105.8/87
R3016	7030003400	S.RES ERJ3GEYJ 471 V (470)	T	113.1/85
R3017	7030003360	S.RES ERJ3GEYJ 221 V (220)	T	97.7/67.6
R3018	7030003640	S.RES ERJ3GEYJ 473 V (47K)	T	125.5/49.1
R3019	7030003440	S.RES ERJ3GEYJ 102 V (1K)	T	122.6/83
R3020	7030003640	S.RES ERJ3GEYJ 473 V (47K)	T	122.6/86.5
R3023	7030009591	S.RES ERA3YED 472V (4.7K)	T	47.1/29.7
R3024	7030003480	S.RES ERJ3GEYJ 222 V (2.2K)	T	47.1/32.5
R3025	7030003640	S.RES ERJ3GEYJ 473 V (47K)	T	45.2/27
R3026	7030003640	S.RES ERJ3GEYJ 473 V (47K)	T	45.2/30.8
R3027	7030009591	S.RES ERA3YED 472V (4.7K)	T	145.6/42.6
R3028	7030003640	S.RES ERJ3GEYJ 473 V (47K)	T	144.2/44.4
R3029	7030003580	S.RES ERJ3GEYJ 153 V (15K)	T	137.5/46.5
R3030	7030003600	S.RES ERJ3GEYJ 223 V (22K)	T	134.6/44.1
R3035	7030003600	S.RES ERJ3GEYJ 223 V (22K)	T	149.1/45.1
R3036	7030003640	S.RES ERJ3GEYJ 473 V (47K)	T	110.9/87
R3050	7030005691	S.RES ERA3YED 123V (12K)	T	115.4/89.2

[MAIN UNIT]

REF NO.	PARTS NO.	DESCRIPTION	M.	H/V LOCATION
R3051	7030009591	S.RES ERA3YED 472V (4.7K)	T	108.7/89.7
R3052	7030005871	S.RES ERA3YKD 104V (100K)	T	110.7/89.7
R3101	7030010420	S.RES ERJ1TYJ 560U (56)	T	139.6/32.2
R3201	7030003640	S.RES ERJ3GEYJ 473 V (47K)	T	84.9/38
R3202	7030005871	S.RES ERA3YKD 104V (100K)	T	91.6/42.1
R3203	7030003440	S.RES ERJ3GEYJ 102 V (1K)	T	89/42.1
R3204	7030003640	S.RES ERJ3GEYJ 473 V (47K)	T	93.2/43.9
R3301	7030003560	S.RES ERJ3GEYJ 103 V (10K)	T	118.8/77.1
R3302	7030003560	S.RES ERJ3GEYJ 103 V (10K)	T	119.8/78.4
R3303	7030003650	S.RES ERJ3GEYJ 563 V (56K)	T	101.6/68.2
R3304	7030003650	S.RES ERJ3GEYJ 563 V (56K)	T	101.6/65.5
R3305	7030003560	S.RES ERJ3GEYJ 103 V (10K)	T	107.2/68.1
R3306	7030003610	S.RES ERJ3GEYJ 273 V (27K)	T	121.3/83
R3307	7030003360	S.RES ERJ3GEYJ 221 V (220)	T	124.2/49.1
R3308	7030003360	S.RES ERJ3GEYJ 221 V (220)	T	97.7/79.6
R3309	7030003360	S.RES ERJ3GEYJ 221 V (220)	T	97.7/73.1
R3310	7030003360	S.RES ERJ3GEYJ 221 V (220)	T	97.7/71.8
R3311	7030003360	S.RES ERJ3GEYJ 221 V (220)	T	97.7/70.5
R3312	7030003440	S.RES ERJ3GEYJ 102 V (1K)	T	97.7/69.2
R3313	7030005871	S.RES ERA3YKD 104V (100K)	T	121.5/49.1
R3314	7030005871	S.RES ERA3YKD 104V (100K)	T	119.4/44.8
R3315	7030003560	S.RES ERJ3GEYJ 103 V (10K)	T	109.1/32.8
R3316	7030003720	S.RES ERJ3GEYJ 224 V (220K)	T	136.9/83
R3317	7030003720	S.RES ERJ3GEYJ 224 V (220K)	T	138.2/83
R3318	7030003720	S.RES ERJ3GEYJ 224 V (220K)	T	139.5/83
R3319	7030003720	S.RES ERJ3GEYJ 224 V (220K)	T	141.6/81.4
R3320	7030003720	S.RES ERJ3GEYJ 224 V (220K)	T	135.6/83
R3321	7030003720	S.RES ERJ3GEYJ 224 V (220K)	T	134.3/83
R3322	7030003720	S.RES ERJ3GEYJ 224 V (220K)	T	133/83
R3323	7030003720	S.RES ERJ3GEYJ 224 V (220K)	T	131.7/83
R3324	7030003720	S.RES ERJ3GEYJ 224 V (220K)	T	130.4/83
R3325	7030003720	S.RES ERJ3GEYJ 224 V (220K)	T	129.1/83
R3326	7030003720	S.RES ERJ3GEYJ 224 V (220K)	T	127.8/83
R3327	7030003720	S.RES ERJ3GEYJ 224 V (220K)	T	126.5/83
R3328	7030003720	S.RES ERJ3GEYJ 224 V (220K)	T	125.2/83
R3329	7030003720	S.RES ERJ3GEYJ 224 V (220K)	T	123.9/83
R3330	7030003720	S.RES ERJ3GEYJ 224 V (220K)	T	129.6/49.1
R3331	7030003720	S.RES ERJ3GEYJ 224 V (220K)	T	128.3/49.1
R3332	7030003640	S.RES ERJ3GEYJ 473 V (47K)	T	110.9/45.8
R3333	7030003360	S.RES ERJ3GEYJ 221 V (220)	T	109.5/47.5
R3334	7030003640	S.RES ERJ3GEYJ 473 V (47K)	T	114.9/46.3
R3335	7030003360	S.RES ERJ3GEYJ 221 V (220)	T	113/47.6
R3336	7030003360	S.RES ERJ3GEYJ 221 V (220)	T	115.8/49.1
R3337	7030003360	S.RES ERJ3GEYJ 221 V (220)	T	117.1/49.1
R3338	7030003360	S.RES ERJ3GEYJ 221 V (220)	T	142.5/75.2
R3339	7030003360	S.RES ERJ3GEYJ 221 V (220)	T	142.5/73.9
R3340	7030003360	S.RES ERJ3GEYJ 221 V (220)	T	122.9/49.1
R3350	7030003720	S.RES ERJ3GEYJ 224 V (220K)	T	120/87
R3402	7030003560	S.RES ERJ3GEYJ 103 V (10K)	T	138.2/86.5
R3403	7030003560	S.RES ERJ3GEYJ 103 V (10K)	T	139.5/86.5
R3405	7030003560	S.RES ERJ3GEYJ 103 V (10K)	T	135.6/86.5
R3406	7030003560	S.RES ERJ3GEYJ 103 V (10K)	T	134.3/86.5
R3408	7030003360	S.RES ERJ3GEYJ 103 V (10K)	T	131.7/86.5
R3411	7030003560	S.RES ERJ3GEYJ 103 V (10K)	T	127.8/86.5
R3412	7030003560	S.RES ERJ3GEYJ 103 V (10K)	T	126.5/86.5
R3601	7030003640	S.RES ERJ3GEYJ 473 V (47K)	T	71.3/23.7
R3602	7030003640	S.RES ERJ3GEYJ 473 V (47K)	T	76.4/23.7
R3603	7030003640	S.RES ERJ3GEYJ 473 V (47K)	T	81.8/23.7
R3604	7030003640	S.RES ERJ3GEYJ 473 V (47K)	T	77.7/23.7
R3605	7030003640	S.RES ERJ3GEYJ 473 V (47K)	T	72.8/23.7
R3606	7030003640	S.RES ERJ3GEYJ 473 V (47K)	T	74.1/23.7
R3608	7030003640	S.RES ERJ3GEYJ 473 V (47K)	T	86.2/57.1
R3609	7030003640	S.RES ERJ3GEYJ 473 V (47K)	T	87.3/53.8
R3610	7030003640	S.RES ERJ3GEYJ 473 V (47K)	T	86/53.8
R3611	7030003640	S.RES ERJ3GEYJ 473 V (47K)	T	84.7/53.8
R3612	7030003640	S.RES ERJ3GEYJ 473 V (47K)	T	83.4/53.8
R3613	7030003640	S.RES ERJ3GEYJ 473 V (47K)	T	142.5/57
R3614	7030003360	S.RES ERJ3GEYJ 221 V (220)	T	142.5/71.3
R3615	7030003360	S.RES ERJ3GEYJ 221 V (220)	T	142.5/68.7
R3616	7030003360	S.RES ERJ3GEYJ 221 V (220)	T	142.5/76.5
R3617	7030003360			

[MAIN UNIT]

REF NO.	PARTS NO.	DESCRIPTION	M.	H/V LOCATION
R9062	7030003640	S.RES ERJ3GEYJ 473 V (47K)	T	171.8/20.1
R9063	7030003640	S.RES ERJ3GEYJ 473 V (47K)	T	161.9/6.6
R9064	7030003640	S.RES ERJ3GEYJ 473 V (47K)	T	212.4/22.1
R9066	7030003860	S.RES ERJ3GE JPW V	T	184.7/12.6
R9067	7030003860	S.RES ERJ3GE JPW V	T	183.2/12.6
R9070	7030003860	S.RES ERJ3GE JPW V	T	180.8/12.7
R9071	7030003860	S.RES ERJ3GE JPW V	T	178.8/12.6
R9074	7030003640	S.RES ERJ3GEYJ 473 V (47K)	T	203.8/16.4
R9101	7030003440	S.RES ERJ3GEYJ 102 V (1K)	T	29.4/27.3
R9102	7030009591	S.RES ERA3YED 472V (4.7K)	T	47.8/16.4
R9103	7030003640	S.RES ERJ3GEYJ 473 V (47K)	T	54.6/14.8
R9104	7030003640	S.RES ERJ3GEYJ 473 V (47K)	T	57.9/12.6
R9106	7030003280	S.RES ERJ3GEYJ 470 V (47)	T	32.8/22.4
R9153	7030003440	S.RES ERJ3GEYJ 102 V (1K)	T	222.2/12.6
R9154	7030003440	S.RES ERJ3GEYJ 102 V (1K)	T	249.4/12.5
R9159	7030003440	S.RES ERJ3GEYJ 102 V (1K)	T	227.7/12.6
R9161	7030003640	S.RES ERJ3GEYJ 473 V (47K)	T	220.7/12.6
R9162	7030003640	S.RES ERJ3GEYJ 473 V (47K)	T	249.4/13.8
R9163	7030003640	S.RES ERJ3GEYJ 473 V (47K)	T	229.2/12.6
R9164	7030003360	S.RES ERJ3GEYJ 221 V (220)	T	233.3/11.9
R9165	7030005871	S.RES ERA3YKD 104V (100K)	T	244.6/12.7
R9166	7030005871	S.RES ERA3YKD 104V (100K)	T	243.3/12.7
R9167	7030005871	S.RES ERA3YKD 104V (100K)	T	245.9/12.7
R9168	7030005871	S.RES ERA3YKD 104V (100K)	T	247.2/12.7
R9169	7030005871	S.RES ERA3YKD 104V (100K)	T	247.2/17.2
R9170	7030005871	S.RES ERA3YKD 104V (100K)	T	245.9/17.2
R9171	7030005871	S.RES ERA3YKD 104V (100K)	T	243.3/17.2
R9172	7030005871	S.RES ERA3YKD 104V (100K)	T	244.6/17.2
C1	4030007110	S.CER C1608 CH 1H 680J-T	T	204.3/130.1
C2	4030007120	S.CER C1608 CH 1H 820J-T	T	200.5/130.1
C3	4030007150	S.CER C1608 CH 1H 151J-T	T	200.5/132.9
C4	4030007050	S.CER C1608 CH 1H 220J-T	T	198.6/132.7
C5	4030007120	S.CER C1608 CH 1H 820J-T	T	198.6/134
C6	4030011600	S.CER C1608 JB 1E 104K-T	T	191.7/131.1
C7	4030011600	S.CER C1608 JB 1E 104K-T	T	196.5/133.7
C8	4030011600	S.CER C1608 JB 1E 104K-T	T	191.7/129.8
C9	4030011600	S.CER C1608 JB 1E 104K-T	T	188.5/130.7
C10	4030011600	S.CER C1608 JB 1E 104K-T	T	186.6/133.8
C11	4030011600	S.CER C1608 JB 1E 104K-T	T	184/133.8
C54	4030011600	S.CER C1608 JB 1E 104K-T	T	171.5/129.5
C56	4030006870	S.CER C1608 JB 1H 222K-T	T	174.2/129.5
C57	4030006900	S.CER C1608 JB 1H 103K-T	T	175.1/131.4
C59	4030010020	S.CER C1608 JB 1H 122K-T	T	176.9/129.5
C61	4030008860	S.CER C1608 JB 1H 153K-T	T	176.4/131.4
C62	4030006870	S.CER C1608 JB 1H 222K-T	T	179.7/130.8
C63	4030008860	S.CER C1608 JB 1H 153K-T	T	177.7/131.4
C64	4030011600	S.CER C1608 JB 1E 104K-T	T	166.5/124.6
C65	4030011600	S.CER C1608 JB 1E 104K-T	T	183.3/127.8
C66	4030011600	S.CER C1608 JB 1E 104K-T	T	168.4/127.9
C67	4030011600	S.CER C1608 JB 1E 104K-T	T	167.1/127.9
C68	4030011600	S.CER C1608 JB 1E 104K-T	T	163.9/126.4
C101	4030011600	S.CER C1608 JB 1E 104K-T	T	163.6/121.8
C102	4030011600	S.CER C1608 JB 1E 104K-T	T	171.1/123.1
C103	4030011600	S.CER C1608 JB 1E 104K-T	T	178/123.1
C104	4030011600	S.CER C1608 JB 1E 104K-T	T	185/123.1
C105	4030011600	S.CER C1608 JB 1E 104K-T	T	191.8/123.2
C106	4030011600	S.CER C1608 JB 1E 104K-T	T	198.5/123.3
C107	4030011600	S.CER C1608 JB 1E 104K-T	T	205.5/123.3
C108	4030011600	S.CER C1608 JB 1E 104K-T	T	211.7/124.4
C109	4030006870	S.CER C1608 JB 1H 222K-T	T	158.5/116.6
C110	4030009980	S.CER C1608 JB 1H 152K-T	T	163.7/119.7
C111	4030010040	S.CER C1608 JB 1H 561K-T	T	172.2/118.8
C112	4030010040	S.CER C1608 JB 1H 561K-T	T	179.4/120.1
C113	4030006850	S.CER C1608 JB 1H 471K-T	T	186.1/120
C114	4030011330	S.CER C1608 CH 1H 391J-T	T	192.9/120.1
C115	4030007170	S.CER C1608 CH 1H 221J-T	T	199.6/120.1
C116	4030007130	S.CER C1608 CH 1H 101J-T	T	205.2/119.6
C117	4030007150	S.CER C1608 CH 1H 151J-T	T	213.3/120.8
C118	4030011280	S.CER C1608 CH 1H 271J-T	T	172.2/120.1
C119	4030011280	S.CER C1608 CH 1H 271J-T	T	159.3/114.7
C120	4030007130	S.CER C1608 CH 1H 101J-T	T	166.3/119.7
C121	4030007130	S.CER C1608 CH 1H 101J-T	T	179.4/118.8
C122	4030007100	S.CER C1608 CH 1H 560J-T	T	186.1/118.7
C123	4030007080	S.CER C1608 CH 1H 390J-T	T	192.9/118.8
C124	4030007090	S.CER C1608 CH 1H 470J-T	T	199.6/118.8
C125	4030007050	S.CER C1608 CH 1H 220J-T	T	207.1/120.1
C126	4030007040	S.CER C1608 CH 1H 180J-T	T	213.3/119.5
C127	4030008920	S.CER C1608 JB 1H 473K-T	T	162/112.5
C128	4030009970	S.CER C1608 JB 1H 182K-T	T	158.5/112.7
C129	4030009980	S.CER C1608 JB 1H 152K-T	T	169/114.3
C130	4030009980	S.CER C1608 JB 1H 152K-T	T	164.6/117.5
C131	4030009980	S.CER C1608 JB 1H 152K-T	T	171.8/115.4
C132	4030007140	S.CER C1608 CH 1H 121J-T	T	174.1/114.8
C133	4030010040	S.CER C1608 JB 1H 561K-T	T	171.1/117.4
C134	4030006850	S.CER C1608 JB 1H 471K-T	T	178.3/117.4
C135	4030010760	S.CER C1608 CH 1H 331J-T	T	185/117.3
C136	4030011280	S.CER C1608 CH 1H 271J-T	T	192.8/114.4
C137	4030007150	S.CER C1608 CH 1H 151J-T	T	191.8/115.7
C138	4030011280	S.CER C1608 CH 1H 271J-T	T	199.1/115.5
C139	4030007170	S.CER C1608 CH 1H 221J-T	T	198.4/117.4
C140	4030007160	S.CER C1608 CH 1H 181J-T	T	205.7/116.4
C141	4030007160	S.CER C1608 CH 1H 181J-T	T	205/118.3
C142	4030007150	S.CER C1608 CH 1H 151J-T	T	212.8/115.5
C143	4030007130	S.CER C1608 CH 1H 101J-T	T	212.1/117.4
C144	4030007140	S.CER C1608 CH 1H 121J-T	T	181.4/114.8
C145	4030010040	S.CER C1608 JB 1H 561K-T	T	179/115.5
C146	4030006850	S.CER C1608 JB 1H 471K-T	T	185.7/115.2
C147	4030008850	S.CER C1608 JB 1H 123K-T	T	164.5/116.1
C148	4030006880	S.CER C1608 JB 1H 472K-T	T	171.1/113
C149	4030009970	S.CER C1608 JB 1H 182K-T	T	178.4/112.9
C150	4030006870	S.CER C1608 JB 1H 222K-T	T	186.1/113.3
C151	4030006870	S.CER C1608 JB 1H 222K-T	T	192.7/113.1
C152	4030009980	S.CER C1608 JB 1H 152K-T	T	199.5/113.6

[MAIN UNIT]

REF NO.	PARTS NO.	DESCRIPTION	M.	H/V LOCATION
C153	4030009980	S.CER C1608 JB 1H 152K-T	T	205.5/114.4
C154	4030006880	S.CER C1608 JB 1H 102K-T	T	213.3/113.5
C155	4030009980	S.CER C1608 JB 1H 152K-T	T	168.4/111.7
C156	4030011600	S.CER C1608 JB 1E 104K-T	T	163.8/113.9
C157	4030006870	S.CER C1608 JB 1H 222K-T	T	171.1/111.7
C158	4030009980	S.CER C1608 JB 1H 152K-T	T	178.1/111
C159	4030006880	S.CER C1608 JB 1H 472K-T	T	186.1/112
C160	4030007170	S.CER C1608 CH 1H 221J-T	T	196.5/110.7
C161	4030011600	S.CER C1608 JB 1E 104K-T	T	191.9/110.8
C162	4030007160	S.CER C1608 CH 1H 181J-T	T	202.7/110.3
C163	4030011600	S.CER C1608 JB 1E 104K-T	T	199.5/112.2
C164	4030007150	S.CER C1608 CH 1H 151J-T	T	210.6/112.6
C165	4030011600	S.CER C1608 JB 1E 104K-T	T	205.5/113
C166	4030007130	S.CER C1608 CH 1H 101J-T	T	217.2/109.9
C167	4030011600	S.CER C1608 JB 1E 104K-T	T	213.3/112.1
C168	4030011600	S.CER C1608 JB 1E 104K-T	T	158.9/121.1
C169	4030006880	S.CER C1608 JB 1H 102K-T	T	175.5/112.5
C170	4030011600	S.CER C1608 JB 1E 104K-T	T	171.1/109.9
C171	4030006850	S.CER C1608 JB 1H 471K-T	T	182.4/112.9
C172	4030011600	S.CER C1608 JB 1E 104K-T	T	178.1/109.7
C173	4030010760	S.CER C1608 CH 1H 331J-T	T	189.1/110.3
C174	4030011600	S.CER C1608 JB 1E 104K-T	T	184.3/110.1
C175	4030007040	S.CER C1608 CH 1H 180J-T	T	199.7/121.4
C176	4030010020	S.CER C1608 JB 1H 122K-T	T	167.7/114.3
C177	4030007130	S.CER C1608 CH 1H 101J-T	T	205.2/120.9
C178	4030007130	S.CER C1608 CH 1H 101J-T	T	165/119.7
C179	4030007150	S.CER C1608 CH 1H 151J-T	T	191.8/117
C201	4030011600	S.CER C1608 JB 1E 104K-T	T	190.2/104.7
C202	4030007120	S.CER C1608 CH 1H 820J-T	T	192.7/97.9
C203	4030007050	S.CER C1608 CH 1H 220J-T	T	190/97.9
C204	4030007150	S.CER C1608 CH 1H 151J-T	T	189.2/96
C205	4030009910	S.CER C1608 CH 1H 040B-T	T	183.5/101.9
C206	4030007130	S.CER C1608 CH 1H 101J-T	T	188/101.8
C207	4030011600	S.CER C1608 JB 1E 104K-T	T	182/96.5
C208	4030006880	S.CER C1608 JB 1H 472K-T	T	216/59.1
C209	4030011600	S.CER C1608 JB 1E 104K-T	T	185.5/86.5
C210	4030011600	S.CER C1608 JB 1E 104K-T	T	178.4/86.4
C211	4030006880	S.CER C1608 JB 1H 472K-T	T	216.1/51.2
C212	4030011600	S.CER C1608 JB 1E 104K-T	T	186.1/72.1
C213	4030009910	S.CER C1608 CH 1H 040B-T	T	180/74.9
C214	4030006880	S.CER C1608 JB 1H 102K-T	T	191.1/77.3
C215	4030006970	S.CER C1608 CH 1H 060D-T	T	170.3/64.3
C217	4030006960	S.CER C1608 CH 1H 050C-T	T	188.6/54.9
C218	4030006880	S.CER C1608 JB 1H 472K-T	T	184.4/49.1
C219	4030006880	S.CER C1608 JB 1H 472K-T	T	192.7/51.2
C220	4030006880	S.CER C1608 JB 1H 472K-T	T	191.2/51.5
C221	4030006880	S.CER C1608 JB 1H 472K-T	T	192.4/57.9
C223	4030006880	S.CER C1608 JB 1H 472K-T	T	202.5/49.3
C224	4030006880	S.CER C1608 JB 1H 472K-T	T	186.3/47.7
C225	4030006970	S.CER C1608 CH 1H 060D-T	T	170.3/63
C226	4030009910	S.CER C1608 CH 1H 040B-T	T	182.2/101.9
C227	4030006960	S.CER C1608 CH 1H 050C-T	T	180/77.5
C301	4030006880	S.CER C1608 JB 1H 472K-T	T	206.1/50.8
C302	4030006970	S.CER C1608 CH 1H 060D-T	T	211.3/43.9
C303	4030006960	S.CER C1608 CH 1H 050C-T	T	200/43.2
C305	4030006850	S.CER C1608 JB 1H 471K-T	T	160/54.7
C307	4030011280	S.CER C1608 CH 1H 271J-T	T	158.7/63.6
C308	4030009580	S.CER C1608 JB 1H 681K-T	T	161.5/64.9
C309	4030011600	S.CER C1608 JB 1E 104K-T	T	159.3/65.6
C310	4030006880	S.CER C1608 JB 1H 472K-T	T	163.7/68.4
C311	4030009970	S.CER C1608 JB 1H 182K-T	T	158.2/71.7
C312	4030011600	S.CER C1608 JB 1E 104K-T	T	209.2/59.2
C314	4030006860	S.CER C1608 JB 1H 102K-T	T	164.8/54.6
C315	4030006870	S.CER C1608 JB 1H 222K-T	T	159.5/71.7
C401	4030011600	S.CER C1608 JB 1E 104K-T	T	164.6/75.5
C402	4030006880	S.CER C1608 JB 1H 472K-T	T	141/98.7
C403	4030011600	S.CER C1608 JB 1E 104K-T	T	140.3/103.4
C404	4030011600	S.CER C1608 JB 1E 104K-T	T	138.7/105.2
C405	4030006880	S.CER C1608 JB 1H 472K-T	T	136.3/104.7
C406	4030011600	S.CER C1608 JB 1E 104K-T	T	136/99.9

[MAIN UNIT]

REF NO.	PARTS NO.	DESCRIPTION	M.	H/V LOCATION
C610	4030009510	S.CER C1608 CH 1H 010B-T	T	195.7/73
C611	4030011600	S.CER C1608 JB 1E 104K-T	T	191.2/69.3
C612	4030007060	S.CER C1608 CH 1H 270J-T	T	205.2/78.2
C701	4030011600	S.CER C1608 JB 1E 104K-T	T	199.7/95.4
C702	4030011600	S.CER C1608 JB 1E 104K-T	T	204.9/104.1
C703	4030011600	S.CER C1608 JB 1E 104K-T	T	201.9/67.7
C705	4030011600	S.CER C1608 JB 1E 104K-T	T	215.2/97.5
C706	4030007060	S.CER C1608 CH 1H 270J-T	T	208.6/97.5
C707	4030006970	S.CER C1608 CH 1H 060D-T	T	210.4/99.5
C709	4030007080	S.CER C1608 CH 1H 390J-T	T	211.2/97.5
C710	4030007040	S.CER C1608 CH 1H 180J-T	T	215.5/100.6
C711	4030007050	S.CER C1608 CH 1H 220J-T	T	213.3/97.5
C712	4030011600	S.CER C1608 JB 1E 104K-T	T	206.5/81
C714	4030011600	S.CER C1608 JB 1E 104K-T	T	199.6/67.6
C715	4030006960	S.CER C1608 CH 1H 050C-T	T	210.2/73.7
C716	4030006860	S.CER C1608 JB 1H 102K-T	T	198.3/67.1
C717	4030006860	S.CER C1608 JB 1H 102K-T	T	206.4/57.8
C718	4030006860	S.CER C1608 JB 1H 102K-T	T	194.2/66.6
C720	4030007080	S.CER C1608 CH 1H 390J-T	T	209.6/55.8
C721	4030006970	S.CER C1608 CH 1H 060D-T	T	209.9/97.5
C801	4030011600	S.CER C1608 JB 1E 104K-T	T	136.3/95.6
C802	4030011600	S.CER C1608 JB 1E 104K-T	T	138.3/98.8
C804	4030006880	S.CER C1608 JB 1H 472K-T	T	132.7/90.3
C805	4030006880	S.CER C1608 JB 1H 472K-T	T	130.6/93
C806	4510009330	S.ELE EEEHA1E470WP	T	154.6/100
C901	4030011600	S.CER C1608 JB 1E 104K-T	T	80.5/77.3
C902	4030011600	S.CER C1608 JB 1E 104K-T	T	85.5/75.4
C903	4030006880	S.CER C1608 JB 1H 472K-T	T	79.7/79.9
C904	4030011600	S.CER C1608 JB 1E 104K-T	T	85.4/80
C905	4030011600	S.CER C1608 JB 1E 104K-T	T	75.8/83
C906	4030011600	S.CER C1608 JB 1E 104K-T	T	77.9/78.2
C907	4030011600	S.CER C1608 JB 1E 104K-T	T	77.1/79.9
C908	4510008970	S.ELE EEEHB1C100R	T	78.3/88.2
C909	4030011600	S.CER C1608 JB 1E 104K-T	T	74.5/83
C910	4030011600	S.CER C1608 JB 1E 104K-T	T	82.6/87.6
C1001	4030011600	S.CER C1608 JB 1E 104K-T	T	74.4/54.2
C1002	4030011600	S.CER C1608 JB 1E 104K-T	T	76.2/58.3
C1003	4030011600	S.CER C1608 JB 1E 104K-T	T	81.7/57.3
C1004	4030009970	S.CER C1608 JB 1H 182K-T	T	79/59.6
C1005	4030010040	S.CER C1608 JB 1H 561K-T	T	79/58.3
C1006	4030006880	S.CER C1608 JB 1H 472K-T	T	81.7/59.9
C1007	4030006880	S.CER C1608 JB 1H 472K-T	T	81.7/58.6
C1008	4030006880	S.CER C1608 JB 1H 472K-T	T	87/63.8
C1010	4510008970	S.ELE EEEHB1C100R	T	92.3/56.1
C1011	4510008970	S.ELE EEEHB1C100R	T	83.5/69.6
C1012	4030011600	S.CER C1608 JB 1E 104K-T	T	89.8/68.6
C1051	4510008970	S.ELE EEEHB1C100R	T	67.6/47.7
C1052	4510008970	S.ELE EEEHB1C100R	T	79.7/40.8
C1054	4030006900	S.CER C1608 JB 1H 103K-T	T	78.7/48.9
C1055	4030006860	S.CER C1608 JB 1H 102K-T	T	77.4/49
C1056	4030008880	S.CER C1608 JB 1H 223K-T	T	74.8/50
C1057	4030008880	S.CER C1608 JB 1H 223K-T	T	73.5/50
C1058	4030008880	S.CER C1608 JB 1H 223K-T	T	80.3/48.1
C1059	4030006900	S.CER C1608 JB 1H 103K-T	T	78.9/45.9
C1061	4030006860	S.CER C1608 JB 1H 102K-T	T	76/40
C1062	4030008880	S.CER C1608 JB 1H 223K-T	T	72.1/40
C1063	4030008880	S.CER C1608 JB 1H 223K-T	T	73.4/40
C1064	4030008880	S.CER C1608 JB 1H 223K-T	T	70.7/44.1
C1101	4030011600	S.CER C1608 JB 1E 104K-T	T	41.9/88.6
C1102	4030011600	S.CER C1608 JB 1E 104K-T	T	48.1/80
C1201	4030006880	S.CER C1608 JB 1H 472K-T	T	128.1/112.9
C1202	4030011600	S.CER C1608 JB 1E 104K-T	T	119.2/121.7
C1203	4030011600	S.CER C1608 JB 1E 104K-T	T	114.4/109.1
C1205	4510008970	S.ELE EEEHB1C100R	T	132.4/111
C1206	4030006860	S.CER C1608 JB 1H 102K-T	T	133.7/114.9
C1208	4030006860	S.CER C2012 JF 1C 105Z-T	T	133.2/120.3
C1209	4030011600	S.CER C1608 JB 1E 104K-T	T	142.7/123
C1210	4030006860	S.CER C2012 JF 1C 105Z-T	T	129.7/120.3
C1211	4030006860	S.CER C2012 JF 1C 105Z-T	T	131.5/120.3
C1212	4030006860	S.CER C2012 JF 1C 105Z-T	T	136/115.2
C1213	4030006860	S.CER C2012 JF 1C 105Z-T	T	136.3/113.4
C1214	4030011600	S.CER C1608 JB 1E 104K-T	T	119.7/110.4
C1301	4030011600	S.CER C1608 JB 1E 104K-T	T	94.6/133.8
C1302	4030011600	S.CER C1608 JB 1E 104K-T	T	95.9/133.8
C1303	4030011600	S.CER C1608 JB 1E 104K-T	T	97.2/133.8
C1304	4030011600	S.CER C1608 JB 1E 104K-T	T	98.5/133.8
C1305	4030011600	S.CER C1608 JB 1E 104K-T	T	99.8/133.8
C1306	4030011600	S.CER C1608 JB 1E 104K-T	T	101.1/133.8
C1307	4030011600	S.CER C1608 JB 1E 104K-T	T	102.4/133.8
C1308	4030011600	S.CER C1608 JB 1E 104K-T	T	103.7/133.8
C1309	4030011600	S.CER C1608 JB 1E 104K-T	T	105.6/123.2
C1310	4030011600	S.CER C1608 JB 1E 104K-T	T	174.3/93.2
C1311	4030011600	S.CER C1608 JB 1E 104K-T	T	63.6/115.1
C1312	4510009330	S.ELE EEEHA1E470WP	T	176.3/102.5
C1313	4510009330	S.ELE EEEHB1E4R7R	T	77.3/110.8
C1314	4510009330	S.ELE EEEHA1E470WP	T	59.5/98.9
C1315	4030011600	S.CER C1608 JB 1E 104K-T	T	159.3/104.1
C1451	4030011600	S.CER C1608 JB 1E 104K-T	T	19.3/29.3
C1501	4510009330	S.ELE EEEHA1E470WP	T	15.4/69.2
C1502	4030011600	S.CER C1608 JB 1E 104K-T	T	11.5/73.5
C1503	4030011600	S.CER C1608 JB 1E 104K-T	T	12.4/77.4
C1504	4510008970	S.ELE EEEHB1C100R	T	4.4/85
C1505	4510008970	S.ELE EEEHB1C100R	T	146.4/119.5
C1506	4030011600	S.CER C1608 JB 1E 104K-T	T	147.5/115.8
C1507	4030011600	S.CER C1608 JB 1E 104K-T	T	156.5/114.4
C1508	4510009330	S.ELE EEEHA1E470WP	T	154.4/108.3
C1509	4030006860	S.CER C2012 JF 1C 105Z-T	T	87.4/116.6
C1510	4030006860	S.CER C2012 JF 1C 105Z-T	T	86.2/125
C1551	4030006860	S.CER C2012 JF 1C 105Z-T	T	76.6/132.7
C1552	4510009330	S.ELE EEEHA1E470WP	T	75.2/121.2
C1555	4510009330	S.ELE EEEHA1E470WP	T	67.5/122.5
C1557	4030011600	S.CER C1608 JB 1E 104K-T	T	51.9/132.4
C1558	4510008970	S.ELE EEEHB1C100R	T	55.8/122.4
C1559	4030011600	S.CER C1608 JB 1E 104K-T	T	56.7/126
C1560	4030011600	S.CER C1608 JB 1E 104K-T	T	64.7/127

[MAIN UNIT]

REF NO.	PARTS NO.	DESCRIPTION	M.	H/V LOCATION
C1561	4030007170	S.CER C1608 CH 1H 221J-T	T	62.6/129
C1562	4030011600	S.CER C1608 JB 1E 104K-T	T	59.3/119
C1563	4030007170	S.CER C1608 CH 1H 221J-T	T	63.9/129
C1601	4510006640	ELE 16 ME 1000 CZ	T	
C1602	4030011600	S.CER C1608 JB 1E 104K-T	T	5.7/42.9
C1603	4510009350	S.ELE EEEHA1C471P	T	12.7/38.4
C1604	4510009350	S.ELE EEEHA1C471P	T	5.6/67.4
C1605	4510009350	S.ELE EEEHA1C471P	T	16.4/60.1
C1606	4030006900	S.CER C1608 JB 1H 103K-T	T	2.9/30.8
C1607	4510008970	S.ELE EEEHB1C100R	T	4.8/20.9
C1608	4030011600	S.CER C1608 JB 1E 104K-T	T	21.1/22.6
C1609	4030008680	S.CER C2012 JF 1C 105Z-T	T	26.2/24
C1610	4030011600	S.CER C1608 JB 1E 104K-T	T	23.3/27.4
C1611	4030008680	S.CER C2012 JF 1C 105Z-T	T	45.2/22.6
C1612	4510009310	S.ELE EEEHB1E4R7R	T	38/32.2
C1613	4030011600	S.CER C1608 JB 1E 104K-T	T	39.7/28.4
C1614	4510009350	S.ELE EEEHA1C471P	T	12.7/49.3
C1615	4510008970	S.ELE EEEHB1C100R	T	22.1/40.8
C1616	4510008970	S.ELE EEEHB1C100R	T	22.1/36
C1617	4510008970	S.ELE EEEHB1C100R	T	23.6/46.2
C1618	4030008680	S.CER C2012 JF 1C 105Z-T	T	31.1/49.8
C1619	4030008920	S.CER C1608 JB 1H 473K-T	T	2.9/28
C1621	4510009310	S.ELE EEEHB1E4R7R	T	38/39.8
C1622	4030011600	S.CER C1608 JB 1E 104K-T	T	39.8/36
C1623	4030008680	S.CER C2012 JF 1C 105Z-T	T	31.3/43.3
C1624	4030008680	S.CER C2012 JF 1C 105Z-T	T	28.6/44.6
C1625	4030008680	S.CER C2012 JF 1C 105Z-T	T	26.9/44.6
C1626	4030006880	S.CER C1608 JB 1H 472K-T	T	26.5/22.2
C1627	4030006880	S.CER C1608 JB 1H 472K-T	T	33.1/42.3
C1702	4030011600	S.CER C1608 JB 1E 104K-T	T	28/58.2
C1703	4030011600	S.CER C1608 JB 1E 104K-T	T	23.2/57.9
C1705	4030008680	S.CER C2012 JF 1C 105Z-T	T	34.3/54.3
C1706	4510009310	S.ELE EEEHB1E4R7R	T	41.3/52.1
C1707	4030008850	S.CER C1608 JB 1H 123K-T	T	48.5/50.6
C1709	4030014300	S.CER C1608 JB 1E 563K-T	T	45.9/50.6
C1710	4030014300	S.CER C1608 JB 1E 563K-T	T	45.9/51.9
C1711	4030014300	S.CER C1608 JB 1E 563K-T	T	42.3/39.7
C1713	4510008970	S.ELE EEEHB1C100R	T	38/44.6
C1714	4510008970	S.ELE EEEHB1C100R	T	52.2/50.7
C1715	4030011600	S.CER C1608 JB 1E 104K-T	T	47.8/41.3
C1716	4030011600	S.CER C1608 JB 1E 104K-T	T	74.5/68.1
C1717	4030011600	S.CER C1608 JB 1E 104K-T	T	77.3/62.2
C1718	4030011600	S.CER C1608 JB 1E 104K-T	T	58.1/67.1
C1719	4030011600	S.CER C1608 JB 1E 104K-T	T	61.9/69.7
C1720	4030011600	S.CER C1608 JB 1E 104K-T	T	64.2/68.8
C1721	4030006880	S.CER C1608 JB 1H 472K-T	T	28.8/60.9
C1801	4030011600	S.CER C1608 JB 1E 104K-T	T	134/42.8
C1802	4030006880	S.CER C1608 JB 1H 472K-T	T	143.8/39.1
C1803	4030011600	S.CER C1608 JB 1E 104K-T	T	158.1/30.2
C1804	4030011600	S.CER C1608 JB 1E 104K-T	T	144.3/41.7
C1805	4030011600	S.CER C1608 JB 1E 104K-T	T	147.1/43.5
C1901	4030011600	S.CER C1608 JB 1E 104K-T	T	146.9/124
C1902	4030011600	S.CER C1608 JB 1E 104K-T	T	143.5/125
C1903	4030011600	S.CER C1608 JB 1E 104K-T	T	127.5/122.4
C1904	4030011600	S.CER C1608 JB 1E 104K-T	T	136/125.9
C1905	4030011600	S.CER C1608 JB 1E 104K-T	T	132.9/127.9
C1906	4030011600	S.CER C1608 JB 1E 104K-T	T	122.6/124.5
C1907	4030006880	S.CER C1608 JB 1H 472K-T	T	137.6/128.5
C1908	4030011600	S.CER C1608 JB 1E 104K-T	T	140.8/125
C1909	4030006880	S.CER C1608 JB 1H 472K-T	T	109.9/109.5
C1910	4030006880	S.CER C1608 JB 1H 472K-T	T	119.8/132.9
C1911	4030011600	S.CER C1608 JB 1E 104K-T	T	138.9/128.5
C1912	4510009350	S.ELE EEEHA1C471P	T	156.7/128.2
C1913	4030011600	S.CER C1608 JB 1E 104K-T	T	126/122.7
C2001	4030008880	S.CER C1608 JB 1H 223K-T	T	66.6/42
C2002	4510009310	S.ELE EEEHB1E4R7R	T	66.2/38
C2003	4030011600	S.CER C1608 JB 1E 104K-T	T	59.8/45
C2005	4030006880	S.CER C1608 JB 1H 472K-T	T	60.7/52.7
C2006	4030006880	S.CER C1608 JB 1H 472K-T	T	56/49.2
C2007	4030011600	S.CER C1608 JB 1E 104K-T	T	66.2/51.9
C2008	4030006880	S		

[MAIN UNIT]

REF NO.	PARTS NO.	DESCRIPTION	M.	H/V LOCATION
C2218	4030009580	S.CER C1608 JB 1H 681K-T	T	10.2/116.1
C2219	4030007130	S.CER C1608 CH 1H 101J-T	T	38.1/112.2
C2220	4030007160	S.CER C1608 CH 1H 181J-T	T	27.3/111.2
C2221	4030007110	S.CER C1608 CH 1H 680J-T	T	5.9/109.1
C2222	4030010020	S.CER C1608 JB 1H 122K-T	T	39.6/112.2
C2223	4030007160	S.CER C1608 CH 1H 181J-T	T	29.4/111.2
C2224	4030007110	S.CER C1608 CH 1H 680J-T	T	7.3/109.1
C2225	4030010020	S.CER C1608 JB 1H 122K-T	T	42.1/112.6
C2226	4030009980	S.CER C1608 JB 1H 152K-T	T	31.8/108.3
C2227	4030009580	S.CER C1608 JB 1H 681K-T	T	10.4/110.4
C2228	4030007090	S.CER C1608 CH 1H 470J-T	T	39.6/109.5
C2229	4030007030	S.CER C1608 CH 1H 150J-T	T	14.3/118.4
C2232	4030007100	S.CER C1608 CH 1H 560J-T	T	28.6/107.6
C2234	4030011600	S.CER C1608 JB 1E 104K-T	T	39/106.8
C2235	4030011600	S.CER C1608 JB 1E 104K-T	T	20.8/120.9
C2236	4030011330	S.CER C1608 CH 1H 391J-T	T	27.4/104.7
C2237	4030010020	S.CER C1608 JB 1H 122K-T	T	21/119
C2238	4030011600	S.CER C1608 JB 1E 104K-T	T	6.8/104.1
C2239	4030007060	S.CER C1608 CH 1H 270J-T	T	14.3/119.7
C2240	4030011600	S.CER C1608 JB 1E 104K-T	T	42.2/104.3
C2241	4030011600	S.CER C1608 JB 1E 104K-T	T	34.2/105.5
C2242	4030011600	S.CER C1608 JB 1E 104K-T	T	11.3/106.4
C2243	4030006860	S.CER C1608 JB 1H 102K-T	T	21/117.7
C2244	4030007170	S.CER C1608 CH 1H 221J-T	T	19.1/117
C2245	4030007060	S.CER C1608 CH 1H 270J-T	T	14.7/114
C2246	4030006860	S.CER C1608 JB 1H 102K-T	T	21/116.2
C2247	4030007150	S.CER C1608 CH 1H 151J-T	T	16.6/111
C2248	4030007060	S.CER C1608 CH 1H 270J-T	T	17.9/111
C2249	4030006860	S.CER C1608 JB 1H 102K-T	T	21.2/111.2
C2250	4030006860	S.CER C1608 JB 1H 102K-T	T	21.9/114.3
C2251	4030007040	S.CER C1608 CH 1H 180J-T	T	19.3/106.5
C2252	4030011280	S.CER C1608 CH 1H 271J-T	T	15.4/105
C2253	4030010020	S.CER C1608 JB 1H 122K-T	T	19.2/108.4
C2254	4030011600	S.CER C1608 JB 1E 104K-T	T	21.4/105.8
C2263	4030009510	S.CER C1608 CH 1H 010B-T	T	13.4/113.7
C2264	4030009510	S.CER C1608 CH 1H 010B-T	T	19.2/111
C2266	4030007010	S.CER C1608 CH 1H 100D-T	T	8.6/110.9
C2267	4030011600	S.CER C1608 JB 1E 104K-T	T	46.7/103.1
C2268	4030007080	S.CER C1608 CH 1H 390J-T	T	14.1/106.6
C2269	4030007080	S.CER C1608 CH 1H 390J-T	T	4/106.9
C2270	4030011600	S.CER C1608 JB 1E 104K-T	T	11.3/102.8
C2271	4030007090	S.CER C1608 CH 1H 470J-T	T	25.6/105.4
C2272	4030010760	S.CER C1608 CH 1H 331J-T	T	43/117.4
C2301	4030011600	S.CER C1608 JB 1E 104K-T	T	40.4/100.6
C2302	4030011600	S.CER C1608 JB 1E 104K-T	T	45/92.1
C2303	4030011600	S.CER C1608 JB 1E 104K-T	T	30.6/99.3
C2304	4030006850	S.CER C1608 JB 1H 471K-T	T	8.1/98.9
C2307	4030007040	S.CER C1608 CH 1H 180J-T	T	5.2/89.3
C2308	4030007040	S.CER C1608 CH 1H 180J-T	T	32/79.5
C2309	4030007040	S.CER C1608 CH 1H 180J-T	T	12.4/95.6
C2310	4030007130	S.CER C1608 CH 1H 101J-T	T	8.1/96.2
C2311	4030007140	S.CER C1608 CH 1H 121J-T	T	9.6/96.2
C2402	4030006880	S.CER C1608 JB 1H 472K-T	T	33.3/79.5
C2403	4030006880	S.CER C1608 JB 1H 472K-T	T	32.5/76.9
C2404	4030006880	S.CER C1608 JB 1H 472K-T	T	35.4/81.9
C2405	4030009910	S.CER C1608 CH 1H 040B-T	T	40.5/79.1
C2406	4030011600	S.CER C1608 JB 1E 104K-T	T	35.3/84.5
C2409	4030006880	S.CER C1608 JB 1H 472K-T	T	44.1/76
C2501	4030006880	S.CER C1608 JB 1H 472K-T	T	41.4/74.4
C2502	4030006880	S.CER C1608 JB 1H 472K-T	T	47/70.4
C2503	4030011600	S.CER C1608 JB 1E 104K-T	T	47.3/67.7
C2504	4030009910	S.CER C1608 CH 1H 040B-T	T	45.1/67
C2701	4030011600	S.CER C1608 JB 1E 104K-T	T	41.4/69.4
C2702	4030011600	S.CER C1608 JB 1E 104K-T	T	37.5/62.8
C2703	4030011600	S.CER C1608 JB 1E 104K-T	T	42.4/58.4
C2704	4030011600	S.CER C1608 JB 1E 104K-T	T	42.4/61.1
C2705	4510008970	S.ELE EEEHB1C100R	T	40/66.4
C2706	4030011600	S.CER C1608 JB 1E 104K-T	T	40.1/57.6
C2707	4030011600	S.CER C1608 JB 1E 104K-T	T	45.8/53.2
C2708	4030006880	S.CER C1608 JB 1H 472K-T	T	53.6/63.5
C2710	4510008970	S.ELE EEEHB1C100R	T	54.4/68.6
C2711	4510008970	S.ELE EEEHB1C100R	T	57/53.6
C2712	4030006880	S.CER C1608 JB 1H 472K-T	T	62.5/58.9
C2713	4030006880	S.CER C1608 JB 1H 472K-T	T	61.2/58.9
C2714	4030009970	S.CER C1608 JB 1H 182K-T	T	63.2/56.9
C2715	4030010040	S.CER C1608 JB 1H 561K-T	T	63.2/55.6
C2716	4030011600	S.CER C1608 JB 1E 104K-T	T	61.2/61.6
C2717	4030011600	S.CER C1608 JB 1E 104K-T	T	46.3/58.5
C2718	4030011600	S.CER C1608 JB 1E 104K-T	T	45/58.5
C2719	4030011600	S.CER C1608 JB 1E 104K-T	T	49.4/56.2
C3001	4030008920	S.CER C1608 JB 1H 473K-T	T	109.6/87
C3002	4030008920	S.CER C1608 JB 1H 473K-T	T	112.2/87
C3003	4030008920	S.CER C1608 JB 1H 473K-T	T	114.8/87
C3004	4030008920	S.CER C1608 JB 1H 473K-T	T	116.1/87
C3005	4030008920	S.CER C1608 JB 1H 473K-T	T	118.7/87
C3006	4030011600	S.CER C1608 JB 1E 104K-T	T	34.2/46.3
C3007	4030007130	S.CER C1608 CH 1H 101J-T	T	116.5/42.2
C3008	4030011600	S.CER C1608 JB 1E 104K-T	T	32.9/46.3
C3009	4030011600	S.CER C1608 JB 1E 104K-T	T	31.6/46.3
C3101	4510009330	S.ELE EEEHA1E470WP	T	146.1/26.8
C3102	4030011600	S.CER C1608 JB 1E 104K-T	T	141.7/23.5
C3103	4030011600	S.CER C1608 JB 1E 104K-T	T	138.1/23.7
C3104	4510009330	S.ELE EEEHA1E470WP	T	134/26.7
C3201	4030011600	S.CER C1608 JB 1E 104K-T	T	96.2/46.8
C3202	4030006880	S.CER C1608 JB 1H 472K-T	T	90.3/42.1
C3302	4030011600	S.CER C1608 JB 1E 104K-T	T	119.8/79.7
C3303	4030011600	S.CER C1608 JB 1E 104K-T	T	103.1/70.8
C3304	4030007060	S.CER C1608 CH 1H 270J-T	T	106.5/64.7
C3305	4030007040	S.CER C1608 CH 1H 180J-T	T	106.9/60.8
C3306	4030008850	S.CER C1608 JB 1H 123K-T	T	103.6/64.7
C3307	4030008920	S.CER C1608 JB 1H 473K-T	T	121.3/87
C3308	4030011600	S.CER C1608 JB 1E 104K-T	T	112.4/77.8
C3309	4030006880	S.CER C1608 JB 1H 472K-T	T	112.4/79.2
C3310	4030011600	S.CER C1608 JB 1E 104K-T	T	108.3/63.5
C3311	4030011600	S.CER C1608 JB 1E 104K-T	T	128.6/61.5

[MAIN UNIT]

REF NO.	PARTS NO.	DESCRIPTION	M.	H/V LOCATION
C3312	4030009510	S.CER C1608 CH 1H 010B-T	T	99.7/60.9
C3313	4610001830	S.TRI TZB4S100AB10R00 (TZBX4N100BA110)	T	98.7/57.4
C3314	4030008860	S.CER C1608 JB 1H 153K-T	T	103.6/66
C3315	4030009510	S.CER C1608 CH 1H 010B-T	T	99.7/62.2
C3316	4030007130	S.CER C1608 CH 1H 101J-T	T	47.1/35.3
C3317	4030007170	S.CER C1608 CH 1H 221J-T	T	45.2/25.7
C3601	4030011600	S.CER C1608 JB 1E 104K-T	T	94.3/59.2
C3602	4030011600	S.CER C1608 JB 1E 104K-T	T	105.4/104.5
C3603	4030011600	S.CER C1608 JB 1E 104K-T	T	92.4/46.7
C3604	4030011600	S.CER C1608 JB 1E 104K-T	T	173.5/79.2
C3605	4030011600	S.CER C1608 JB 1E 104K-T	T	66.8/102.9
C3606	4030011600	S.CER C1608 JB 1E 104K-T	T	70.2/97.7
C3801	4510008970	S.ELE EEEHB1C100R	T	153.9/37.5
C3802	4030011600	S.CER C1608 JB 1E 104K-T	T	134.3/51.4
C3901	4030011600	S.CER C1608 JB 1E 104K-T	T	142.5/55.7
C9001	4030006900	S.CER C1608 JB 1H 103K-T	T	144.9/17
C9002	4030006900	S.CER C1608 JB 1H 103K-T	T	126.8/17
C9003	4030011600	S.CER C1608 JB 1E 104K-T	T	140/11.9
C9004	4030006880	S.CER C1608 JB 1H 472K-T	T	151/11.9
C9005	4030011600	S.CER C1608 JB 1E 104K-T	T	148.2/11.9
C9007	4030011600	S.CER C1608 JB 1E 104K-T	T	142.7/11.9
C9051	4030006880	S.CER C1608 JB 1H 472K-T	T	183.9/23.5
C9052	4030006880	S.CER C1608 JB 1H 472K-T	T	166.7/9.8
C9053	4030006900	S.CER C1608 JB 1H 103K-T	T	204.4/24.6
C9054	4030008680	S.CER C2012 JF 1C 105Z-T	T	169.2/11.6
C9055	4030008680	S.CER C2012 JF 1C 105Z-T	T	172.5/11.6
C9056	4030008680	S.CER C2012 JF 1C 105Z-T	T	175.8/11.6
C9057	4030008680	S.CER C2012 JF 1C 105Z-T	T	166.1/16.1
C9058	4030006900	S.CER C1608 JB 1H 103K-T	T	166.7/7.2
C9060	4030006900	S.CER C1608 JB 1H 103K-T	T	209.8/26.9
C9101	4030006880	S.CER C1608 JB 1H 472K-T	T	29.4/26
C9102	4030006880	S.CER C1608 JB 1H 472K-T	T	32.8/19.8
C9103	4030006900	S.CER C1608 JB 1H 103K-T	T	47.8/13.4
C9151	4030011600	S.CER C1608 JB 1E 104K-T	T	237.7/19.1
C9152	4030011600	S.CER C1608 JB 1E 104K-T	T	256.3/17.4
RL2101	6330001320	REL AHY103		
RL9001	6330001790	REL ATX203		
RL9002	6330001790	REL ATX203		
RL9051	6330001790	REL ATX203		
RL9052	6330001790	REL ATX203		
CP1201	6910009670	S.CHE HK3-S-T	T	115.8/133.5
J1	6510007020	CON TMP-J01X-V6		
J51	6510007020	CON TMP-J01X-V6		
J301	6510007020	CON TMP-J01X-V6		
J601	6510007020	CON TMP-J01X-V6		
J1101	6510021651	CON IMSA-9180B-30B-PT1		
J1102	6510022811	CON IMSA-9180B-22B-PT1		
J1301	6510022561	CON 16FMN-BTRK-A(LF)(SN)		
J1451	6510024311	CON B4B-PH-K-S(LF)(SN)		
J1901	6510025470	CON 20FMN-BTRK-A(LF)(SN)		
J2051	6510009421	CON B9B-ZR(LF)(SN)		
J2101	6510007020	CON TMP-J01X-V6		
J2301	6510007020	CON TMP-J01X-V6		
J3001	6510022631	CON 10FMN-BTRK-A(LF)(SN)		
J3601	6510025480	CON 24FMN-BTRK-A(LF)(SN)		
J3801	6510021861	CON BH-800.4GG <LT>		
J9001	6510023120	CON CD6109SA1J0 <CVI>		
J9051	6510023120	CON CD6109SA1J0 <CVI>		
J9151	6510023210	CON CD6125SA1J0 <CVI>		
T9003	5920000570	TRA 12T01		
T9004	5920000570	TRA 12T01		
BT1	3020000110	LIT CR2032		
W2101	7030011280	JUM J1/4ZC		
EP1901	6910012350	S.BEA MMZ1608Y 102BT	T	136.3/128.5
EP3001	6910012350	S.BEA MMZ1608Y 102BT	T	126.8/46.3
EP9001	6910012350	S.BEA MMZ1608Y 102BT	T	152.8/22.8
MP51	8930014140	SPR EARTH SPRING(D)	B	156.6/134.9

M.=Mounted side (T: Mounted on the Top side, B: Mounted on the Bottom side)  
S.=Surface mount



[PLL UNIT]

REF NO.	PARTS NO.	DESCRIPTION	M.	H/V LOCATION
W5201	8970021851	CBL 1.5D300MM-1 C24/C31		
W5601	8970024371	CBL 1.5D140MM-1 C24/C31		
W5801	8970024690	CBL 1.5D180MM C24/C31		
IC5001	1180001071	S.IC TA7805F(TE16L,Q)	T	65.5/32.6
IC5031	1180001251	S.IC TA7808F(TE16L,Q)	T	31.1/14.7
IC5101	1140007881	S.IC TC190G08EFG0046JDZ/SC1246A	T	158/36.5
IC5102	1130004831	S.IC TC7SU04F(TE85R,F)	T	159.2/22.5
IC5103	1130004831	S.IC TC7SU04F(TE85R,F)	T	170/47.1
IC5401	1130009230	S.IC LMX2306TMX/NOPB	T	203.6/46.3
IC5701	1140014960	S.IC TC190G02EFG-0058/SC1287A	T	64.1/65.8
IC5702	1130004831	S.IC TC7SU04F(TE85R,F)	T	56.6/73.7
IC5801	1140014960	S.IC TC190G02EFG-0058/SC1287A	T	36.3/60.9
IC5802	1130004831	S.IC TC7SU04F(TE85R,F)	T	45.5/67.2
IC5901	1140014960	S.IC TC190G02EFG-0058/SC1287A	T	36.4/34.7
IC5902	1130004831	S.IC TC7SU04F(TE85R,F)	T	44.3/42.2
Q5101	1530002691	S.TRA 2SC4116-GR(TE85R,F)	T	147.5/16
Q5202	1530002601	S.TRA 2SC4215-O(TE85R,F)	T	123.8/39.4
Q5281	1530002601	S.TRA 2SC4215-O(TE85R,F)	T	99.9/55.9
Q5301	1560000331	S.FET 2SK210-GR(TE85R,F)	T	193.7/30.6
Q5302	1530002691	S.TRA 2SC4116-GR(TE85R,F)	T	201/31.6
Q5351	1530002601	S.TRA 2SC4215-O(TE85R,F)	T	196.9/19.3
Q5401	1590001330	S.TRA DTA114EUA T106	T	205.9/50.7
Q5521	1560000491	S.FET 2SK508-T2B-A K52	T	138.7/66.4
Q5553	1530002691	S.TRA 2SC4116-GR(TE85R,F)	T	136/75.1
Q5601	1530002601	S.TRA 2SC4215-O(TE85R,F)	T	177.7/67.9
Q5602	1530002601	S.DIO 2SC4215-O(TE85R,F)	T	182.4/70.9
Q5603	1530002601	S.TRA 2SC4215-O(TE85R,F)	T	188.3/66.5
Q5604	1530002601	S.TRA 2SC4215-O(TE85R,F)	T	184.9/60.7
Q5881	1530003151	S.TRA 2SC4673D-TD-E	T	9.1/66
Q5882	1530002601	S.TRA 2SC4215-O(TE85R,F)	T	19.3/61.1
D5101	1750000271	S.DIO 1SS301(TE85L,F)	T	171.1/40.9
D5301	1790000540	S.VAR MA338(TX)	T	183.5/26.8
D5302	1790001211	S.DIO 1SS375-TL-E	T	200.5/26.7
D5303	1790001211	S.DIO 1SS375-TL-E	T	200.5/22.9
D5402	1750000271	S.DIO 1SS301(TE85L,F)	T	212.9/48.3
D5521	1720000831	S.VAR KV1770STL-G	T	146.9/67.4
FI5101	2020001820	S.CER SFECV10M5FA00-R0 (SFECV10.5MA5S)	T	156.8/16.4
X5251	6050011520	XTA CR-604. POCO 32.000 MHz		
L5005	6200009300	S.COI ELJPA 100KF 10U	T	63.5/12.7
L5021	2040000490	COI EXC-ELDR25C		
L5101	6200001831	S.COI NLV32T-100J	T	172.6/18.8
L5202	6200003261	S.COI NLV32T-101J	T	126.9/47.1
L5203	6150004250	COI LS-471A (C-14922)		
L5204	6150004250	COI LS-471A (C-14922)		
L5301	6200003261	S.COI NLV32T-101J	T	183.7/31.4
L5302	6130001850	COI LB-185		
L5303	6200001831	S.COI NLV32T-100J	T	194.1/33.8
L5304	6200003261	S.COI NLV32T-101J	T	199.4/35.4
L5351	6200003261	S.COI NLV32T-101J	T	206/20.3
L5352	6200003101	S.COI NLV32T-3R9J	T	190.7/18.5
L5401	6200001831	S.COI NLV32T-100J	T	210.4/51
L5521	6170000400	COI LW-38		
L5522	6170000400	COI LW-38		
L5523	6190001281	COI #E544GN-110248		
L5552	6200003261	S.COI NLV32T-101J	T	127.7/58.9
L5601	6200003261	S.COI NLV32T-101J	T	176.3/61.9
L5602	6200003421	S.COI NLV32T-R15J	T	192.1/70.1
L5603	6200003431	S.COI NLV32T-FR10J	T	195.1/66.2
L5604	6200003431	S.COI NLV32T-FR10J	T	197.8/69.7
L5605	6200003261	S.COI NLV32T-101J	T	180.7/61.8
L5701	6200009300	S.COI ELJPA 100KF 10U	T	73.9/73.2
L5781	6200001711	S.COI NLV32T-220J	T	75/49
L5782	6200001711	S.COI NLV32T-220J	T	75.6/54
L5783	6200003151	S.COI NLV32T-180J	T	74.3/59.2
L5801	6200009300	S.COI ELJPA 100KF 10U	T	41.4/51.1
L5881	6200001851	S.COI NLV32T-5R6J	T	19.5/50.8
L5882	6200001851	S.COI NLV32T-5R6J	T	24.5/50.2
L5883	6200004900	S.COI ELJFC 5R6K-F	T	29.7/50.9
L5884	6200005011	S.COI NLV25T-100J	T	19.3/67.4
L5885	6200002041	S.COI NLV25T-101J	T	8.7/69.8
L5901	6200009300	S.COI ELJPA 100KF 10U	T	41.7/24.9
L5981	6200003151	S.COI NLV32T-180J	T	21.2/24.6
L5982	6200001711	S.COI NLV32T-220J	T	26.1/24
L5983	6200003141	S.COI NLV32T-150J	T	30.2/24.6
R5002	7030003400	S.RES ERJ3GEYJ 471 V (470)	T	82.4/12.3
R5003	7030003400	S.RES ERJ3GEYJ 471 V (470)	T	78.3/14.5
R5004	7030003400	S.RES ERJ3GEYJ 471 V (470)	T	75.7/14.5
R5005	7030003400	S.RES ERJ3GEYJ 471 V (470)	T	73.1/14.5
R5006	7030003400	S.RES ERJ3GEYJ 471 V (470)	T	70.5/14.5
R5008	7030003400	S.RES ERJ3GEYJ 471 V (470)	T	79.6/14.5
R5009	7030003400	S.RES ERJ3GEYJ 471 V (470)	T	77/14.5
R5010	7030003400	S.RES ERJ3GEYJ 471 V (470)	T	74.4/14.5
R5011	7030003400	S.RES ERJ3GEYJ 471 V (470)	T	71.8/14.5
R5021	7070000820	RES ERG1SJ 220 (22)		
R5022	7070000820	RES ERG1SJ 220 (22)		
R5101	7030007200	S.RES ERA3YEB 202V (2K)	T	142/26.7
R5102	7030007200	S.RES ERA3YEB 202V (2K)	T	142/28.3
R5103	7030007200	S.RES ERA3YEB 202V (2K)	T	142/29.9
R5104	7030007200	S.RES ERA3YEB 202V (2K)	T	142/31.5
R5105	7030007200	S.RES ERA3YEB 202V (2K)	T	142/33.1
R5106	7030007220	S.RES ERA3YED 202V (2K)	T	142/34.7
R5107	7030007220	S.RES ERA3YED 202V (2K)	T	142/36.3
R5108	7030007220	S.RES ERA3YED 202V (2K)	T	142/37.9
R5109	7030007220	S.RES ERA3YED 202V (2K)	T	142/39.5
R5110	7030007220	S.RES ERA3YED 202V (2K)	T	142/41.1
R5111	7030007220	S.RES ERA3YED 202V (2K)	T	142/42.7
R5112	7030007220	S.RES ERA3YED 202V (2K)	T	142/44.3
R5113	7030007210	S.RES ERA3YEB 102V (1K)	T	140/27.5
R5114	7030007210	S.RES ERA3YEB 102V (1K)	T	138.7/29.1
R5115	7030007210	S.RES ERA3YEB 102V (1K)	T	140/30.7
R5116	7030007210	S.RES ERA3YEB 102V (1K)	T	138.7/32.3
R5117	7030007210	S.RES ERA3YEB 102V (1K)	T	140/33.9
R5118	7030007230	S.RES ERA3YED 102V (1K)	T	138.7/35.5
R5119	7030007230	S.RES ERA3YED 102V (1K)	T	140/37.1
R5120	7030007230	S.RES ERA3YED 102V (1K)	T	138.7/38.7
R5121	7030007230	S.RES ERA3YED 102V (1K)	T	140/40.3
R5122	7030007230	S.RES ERA3YED 102V (1K)	T	138.7/41.9
R5123	7030007230	S.RES ERA3YED 102V (1K)	T	140/43.5
R5124	7030007220	S.RES ERA3YED 202V (2K)	T	142/45.9
R5125	7030003320	S.RES ERJ3GEYJ 101 V (100)	T	156.7/24.3
R5126	7030003800	S.RES ERJ3GEYJ 105 V (1M)	T	161.9/22.9
R5127	7030003380	S.RES ERJ3GEYJ 331 V (330)	T	162.1/17.1
R5128	7030003320	S.RES ERJ3GEYJ 101 V (100)	T	152.7/22.8
R5129	7030003380	S.RES ERJ3GEYJ 331 V (330)	T	152.2/15.9
R5130	7030003460	S.RES ERJ3GEYJ 152 V (1.5K)	T	145.4/15.8
R5131	7030003400	S.RES ERJ3GEYJ 471 V (470)	T	149.4/15.9
R5132	7030003490	S.RES ERJ3GEYJ 272 V (2.7K)	T	144/15.8
R5133	7030003640	S.RES ERJ3GEYJ 473 V (47K)	T	165.7/25.4
R5134	7030003640	S.RES ERJ3GEYJ 473 V (47K)	T	167.6/25.9
R5135	7030003800	S.RES ERJ3GEYJ 105 V (1M)	T	169.7/44.7
R5136	7030003680	S.RES ERJ3GEYJ 104 V (100K)	T	169.6/33.9
R5137	7030003440	S.RES ERJ3GEYJ 102 V (1K)	T	169.9/31.5
R5138	7030003400	S.RES ERJ3GEYJ 102 V (1K)	T	153.6/46.2
R5139	7030003440	S.RES ERJ3GEYJ 102 V (1K)	T	150.8/49.4
R5140	7030003640	S.RES ERJ3GEYJ 473 V (47K)	T	156/49.4
R5141	7030003640	S.RES ERJ3GEYJ 473 V (47K)	T	153.4/49.4
R5142	7030003640	S.RES ERJ3GEYJ 473 V (47K)	T	150.3/47.5
R5143	7030003640	S.RES ERJ3GEYJ 473 V (47K)	T	157.3/49.4
R5144	7030003640	S.RES ERJ3GEYJ 473 V (47K)	T	154.7/49.4
R5145	7030003640	S.RES ERJ3GEYJ 473 V (47K)	T	152.1/49.4
R5146	7030003430	S.RES ERJ3GEYJ 821 V (820)	T	169.1/35.8
R5203	7030003320	S.RES ERJ3GEYJ 101 V (100)	T	126.3/41.5
R5204	7030003600	S.RES ERJ3GEYJ 223 V (22K)	T	123.6/41.5
R5205	7030003560	S.RES ERJ3GEYJ 103 V (10K)	T	120.7/41.5
R5206	7030003360	S.RES ERJ3GEYJ 221 V (220)	T	120.7/40
R5207	7030003860	S.RES ERJ3GE JPW V	T	124.3/44.8
R5251	7030003400	S.RES ERJ3GEYJ 471 V (470)	T	99.5/64.9
R5252	7030003860	S.RES ERJ3GE JPW V	T	99.9/62.5
R5281	7030003400	S.RES ERJ3GEYJ 471 V (470)	T	99.2/58.5
R5282	7030003320	S.RES ERJ3GEYJ 101 V (100)	T	98/55.7
R5283	7030003480	S.RES ERJ3GEYJ 222 V (2.2K)	T	101.8/56.1
R5284	7030003520	S.RES ERJ3GEYJ 472 V (4.7K)	T	100.5/58.9
R5302	7030003340	S.RES ERJ3GEYJ 151 V (150)	T	185.9/31.9
R5303	7030003680	S.RES ERJ3GEYJ 104 V (100K)	T	189.8/29.4
R5304	7030003680	S.RES ERJ3GEYJ 104 V (100K)	T	191/36
R5305	7030003340	S.RES ERJ3GEYJ 151 V (150)	T	190.1/33.3
R5306	7030003320	S.RES ERJ3GEYJ 101 V (100)	T	195.2/36
R5307	7030003690	S.RES ERJ3GEYJ 124 V (120K)	T	199/31.7
R5308	7030003320	S.RES ERJ3GEYJ 101 V (100)	T	203.8/31.4
R5309	7030003430	S.RES ERJ3GEYJ 821 V (820)	T	204/28.8
R5310	7030003430	S.RES ERJ3GEYJ 821 V (820)	T	204.5/23.2
R5311	7030003430	S.RES ERJ3GEYJ 821 V (820)	T	203.2/26.5
R5312	7030003400	S.RES ERJ3GEYJ 471 V (470)	T	205.8/23.2
R5351	7030003570	S.RES ERJ3GEYJ 123 V (12K)	T	200.1/19.3
R5352	7030003400	S.RES ERJ3GEYJ 471 V (470)	T	198.8/19.3
R5353	7030003440	S.RES ERJ3GEYJ 102 V (1K)	T	201.5/19.4
R5354	7030003400	S.RES ERJ3GEYJ 471 V (470)	T	186.1/19.4
R5401	7030003860	S.RES ERJ3GE JPW V	T	203/49.9
R5403	7030003450	S.RES ERJ3GEYJ 122 V (1.2K)	T	195.6/47.9
R5404	7030003440	S.RES ERJ3GEYJ 102 V (1K)	T	209.7/44.8
R5406	7030003680	S.RES ERJ3GEYJ 104 V (100K)	T	209.7/48.9
R5407	7030003440	S.RES ERJ3GEYJ 102 V (1K)	T	203/51.3
R5408	7030003440	S.RES ERJ3GEYJ 102 V (1K)	T	209.7/46.2
R5409	7030003860	S.RES ERJ3GE JPW V	T	191.6/51.1
R5410	7030003440	S.RES ERJ3GEYJ 102 V (1K)	T	209.7/47.5
R5411	7030003860	S.RES ERJ3GE JPW V	T	

[PLL UNIT]

REF NO.	PARTS NO.	DESCRIPTION	M.	H/V LOCATION
R5709	7030007210	S.RES ERA3YEB 102V (1K)	T	68.4/54.5
R5710	7030007210	S.RES ERA3YEB 102V (1K)	T	69.7/57.1
R5711	7030007220	S.RES ERA3YED 202V (2K)	T	58/55.5
R5712	7030007220	S.RES ERA3YED 202V (2K)	T	59.3/55.5
R5713	7030007220	S.RES ERA3YED 202V (2K)	T	60.6/55.5
R5714	7030007220	S.RES ERA3YED 202V (2K)	T	61.9/55.5
R5715	7030007220	S.RES ERA3YED 202V (2K)	T	63.2/55.5
R5716	7030007220	S.RES ERA3YED 202V (2K)	T	64.5/55.5
R5717	7030007220	S.RES ERA3YED 202V (2K)	T	65.8/55.5
R5718	7030007200	S.RES ERA3YEB 202V (2K)	T	67.1/55.5
R5719	7030007200	S.RES ERA3YEB 202V (2K)	T	68.4/57.1
R5720	7030007200	S.RES ERA3YEB 202V (2K)	T	72.5/61.5
R5721	7030003800	S.RES ERJ3GEYJ 105 V (1M)	T	59/73.7
R5722	7030003320	S.RES ERJ3GEYJ 101 V (100)	T	60.9/75.1
R5781	7030003410	S.RES ERJ3GEYJ 561 V (560)	T	75.2/45.4
R5782	7030007860	S.RES ERJ3GEYJ 8R2V (8.2)	T	73.8/43.9
R5783	7030003410	S.RES ERJ3GEYJ 561 V (560)	T	75.4/46.7
R5799	7030003440	S.RES ERJ3GEYJ 102 V (1K)	T	72.4/49.1
R5801	7030007220	S.RES ERA3YED 202V (2K)	T	23.4/67.5
R5802	7030007230	S.RES ERA3YED 102V (1K)	T	23.4/66.2
R5803	7030007230	S.RES ERA3YED 102V (1K)	T	23.4/64.9
R5804	7030007230	S.RES ERA3YED 102V (1K)	T	23.4/63.6
R5805	7030007230	S.RES ERA3YED 102V (1K)	T	23.4/62.3
R5806	7030007230	S.RES ERA3YED 102V (1K)	T	23.4/61
R5807	7030007230	S.RES ERA3YED 102V (1K)	T	23.4/59.7
R5808	7030007210	S.RES ERA3YEB 102V (1K)	T	23.4/58.4
R5809	7030007210	S.RES ERA3YEB 102V (1K)	T	25/57.1
R5810	7030007210	S.RES ERA3YEB 102V (1K)	T	27.6/55.8
R5811	7030007220	S.RES ERA3YED 202V (2K)	T	26/67.5
R5812	7030007220	S.RES ERA3YED 202V (2K)	T	26/66.2
R5813	7030007220	S.RES ERA3YED 202V (2K)	T	26/64.9
R5814	7030007220	S.RES ERA3YED 202V (2K)	T	26/63.6
R5815	7030007220	S.RES ERA3YED 202V (2K)	T	26/62.3
R5816	7030007220	S.RES ERA3YED 202V (2K)	T	26/61
R5817	7030007220	S.RES ERA3YED 202V (2K)	T	26/59.7
R5818	7030007200	S.RES ERA3YEB 202V (2K)	T	26/58.4
R5819	7030007200	S.RES ERA3YEB 202V (2K)	T	27.6/57.1
R5820	7030007200	S.RES ERA3YEB 202V (2K)	T	32/52.4
R5821	7030003800	S.RES ERJ3GEYJ 105 V (1M)	T	45.1/69.6
R5822	7030003320	S.RES ERJ3GEYJ 101 V (100)	T	45.4/64.2
R5881	7030000220	S.RES MCR10EZJH 47 (470)	T	12.9/68.1
R5882	7030003440	S.RES ERJ3GEYJ 102 V (1K)	T	13.0/62.8
R5883	7030003450	S.RES ERJ3GEYJ 122 V (1.2K)	T	13.2/63.3
R5885	7030003370	S.RES ERJ3GEYJ 271 V (270)	T	16.9/58.7
R5886	7030003440	S.RES ERJ3GEYJ 102 V (1K)	T	19.3/59.2
R5887	7030003450	S.RES ERJ3GEYJ 122 V (1.2K)	T	19.3/56.5
R5888	7030003280	S.RES ERJ3GEYJ 470 V (47)	T	20.2/63.9
R5889	7030003450	S.RES ERJ3GEYJ 122 V (1.2K)	T	19.3/53.7
R5890	7030003410	S.RES ERJ3GEYJ 561 V (560)	T	16.9/63.9
R5891	7030003400	S.RES ERJ3GEYJ 471 V (470)	T	19.3/55.1
R5892	7030003260	S.RES ERJ3GEYJ 330 V (33)	T	6.9/60.3
R5901	7030007220	S.RES ERA3YED 202V (2K)	T	23.5/41.3
R5902	7030007230	S.RES ERA3YED 102V (1K)	T	23.5/40
R5903	7030007230	S.RES ERA3YED 102V (1K)	T	23.5/38.7
R5904	7030007230	S.RES ERA3YED 102V (1K)	T	23.5/37.4
R5905	7030007230	S.RES ERA3YED 102V (1K)	T	23.5/36.1
R5906	7030007230	S.RES ERA3YED 102V (1K)	T	23.5/34.8
R5907	7030007230	S.RES ERA3YED 102V (1K)	T	23.5/33.5
R5908	7030007210	S.RES ERA3YEB 102V (1K)	T	23.5/32.2
R5909	7030007210	S.RES ERA3YEB 102V (1K)	T	25.1/30.9
R5910	7030007210	S.RES ERA3YEB 102V (1K)	T	27.7/29.6
R5911	7030007220	S.RES ERA3YED 202V (2K)	T	26.1/41.3
R5912	7030007220	S.RES ERA3YED 202V (2K)	T	26.1/40
R5913	7030007220	S.RES ERA3YED 202V (2K)	T	26.1/38.7
R5914	7030007220	S.RES ERA3YED 202V (2K)	T	26.1/37.4
R5915	7030007220	S.RES ERA3YED 202V (2K)	T	26.1/36.1
R5916	7030007220	S.RES ERA3YED 202V (2K)	T	26.1/34.8
R5917	7030007220	S.RES ERA3YED 202V (2K)	T	26.1/33.5
R5918	7030007200	S.RES ERA3YEB 202V (2K)	T	26.1/32.2
R5919	7030007200	S.RES ERA3YEB 202V (2K)	T	27.7/30.9
R5920	7030007200	S.RES ERA3YEB 202V (2K)	T	32.4/26.1
R5921	7030003800	S.RES ERJ3GEYJ 105 V (1M)	T	44.3/39.8
R5922	7030003320	S.RES ERJ3GEYJ 101 V (100)	T	45.5/38.1
R5981	7030003860	S.RES ERJ3GE JPW V	T	18/26.1
R5982	7030003440	S.RES ERJ3GEYJ 102 V (1K)	T	21.4/27.4
C5021	4510009330	S.ELE EEEHA1E470WP	T	57.4/33.6
C5022	4030011600	S.CER C1608 JB 1E 104K-T	T	64.1/25.9
C5023	4030011600	S.CER C1608 JB 1E 104K-T	T	69.7/29.5
C5024	4510009330	S.ELE EEEHA1E470WP	T	72.7/34.6
C5031	4510009330	S.ELE EEEHA1E470WP	T	23.5/15.3
C5032	4030011600	S.CER C1608 JB 1E 104K-T	T	27/10.2
C5033	4030011600	S.CER C1608 JB 1E 104K-T	T	35.2/10.7
C5034	4510009330	S.ELE EEEHA1E470WP	T	38.5/15.3
C5101	4030007060	S.CER C1608 CH 1H 270J-T	T	146.4/29.9
C5102	4030007010	S.CER C1608 CH 1H 100D-T	T	147.6/31.8
C5103	4030006960	S.CER C1608 CH 1H 050C-T	T	147.6/34.5
C5104	4030006880	S.CER C1608 JB 1H 472K-T	T	156.7/21.5
C5105	4030006860	S.CER C1608 JB 1H 102K-T	T	163.5/17.1
C5106	4030006880	S.CER C1608 JB 1H 472K-T	T	148.6/18.1
C5107	4030006880	S.CER C1608 JB 1H 472K-T	T	150.8/15.9
C5108	4030006880	S.CER C1608 JB 1H 472K-T	T	142.6/15.8
C5110	4510008970	S.ELE EEEHB1C100R	T	172.4/14.7
C5111	4030006880	S.CER C1608 JB 1H 472K-T	T	172.4/44.7
C5112	4030007090	S.CER C1608 CH 1H 470J-T	T	168.3/33.9
C5113	4030006880	S.CER C1608 JB 1H 472K-T	T	170.3/29.5
C5115	4030006880	S.CER C1608 JB 1H 472K-T	T	169/29.5
C5116	4510009330	S.ELE EEEHA1E470WP	T	171.9/24.3
C5117	4030006880	S.CER C1608 JB 1H 472K-T	T	168.6/38.1
C5118	4030006880	S.CER C1608 JB 1H 472K-T	T	169.9/38.1
C5120	4030006880	S.CER C1608 JB 1H 472K-T	T	161.1/26.3
C5121	4030006880	S.CER C1608 JB 1H 472K-T	T	159.3/26.3
C5122	4030006880	S.CER C1608 JB 1H 472K-T	T	156.9/26.4
C5123	4030006880	S.CER C1608 JB 1H 472K-T	T	151.9/26.2

[PLL UNIT]

REF NO.	PARTS NO.	DESCRIPTION	M.	H/V LOCATION
C5124	4030006880	S.CER C1608 JB 1H 472K-T	T	150.3/46.2
C5125	4030011600	S.CER C1608 JB 1E 104K-T	T	148.2/43.2
C5126	4030011600	S.CER C1608 JB 1E 104K-T	T	149.1/29.4
C5201	4030006860	S.CER C1608 JB 1H 102K-T	T	127.3/39.2
C5202	4030006860	S.CER C1608 JB 1H 102K-T	T	123.6/42.8
C5203	4030006880	S.CER C1608 JB 1H 472K-T	T	120.7/36.5
C5204	4030006880	S.CER C1608 JB 1H 472K-T	T	120.7/38.7
C5205	4030007030	S.CER C1608 CH 1H 150J-T	T	124.9/36.5
C5206	4030006910	S.CER C1608 CH 1H 0R5C-T	T	119.9/28.2
C5207	4030007030	S.CER C1608 CH 1H 150J-T	T	119.9/23.5
C5251	4030007130	S.CER C1608 CH 1H 101J-T	T	98/66.3
C5253	4030006880	S.CER C1608 JB 1H 472K-T	T	82/70.7
C5254	4510008970	S.ELE EEEHB1C100R	T	84.4/74.6
C5281	4030006880	S.CER C1608 JB 1H 472K-T	T	103.1/56.1
C5282	4030006860	S.CER C1608 JB 1H 102K-T	T	101.8/58.9
C5283	4030006880	S.CER C1608 JB 1H 472K-T	T	111.4/63.8
C5301	4550000730	S.TAN TEESVA 0J 225M8R	T	187.7/33.3
C5302	4030006880	S.CER C1608 JB 1H 472K-T	T	172/34.6
C5303	4030009650	S.CER C1608 CH 1H 240J-T	T	184.2/23.5
C5304	4030011570	S.CER CM105 CH 101G 50AT	T	189.8/25.8
C5305	4610001850	S.TRI TZB4R200AB10R00 (TZBX4R200BA110)	T	186.8/26.9
C5306	4030007150	S.CER C1608 CH 1H 151J-T	T	191.1/25.8
C5307	4030007150	S.CER C1608 CH 1H 151J-T	T	191.1/29.8
C5308	4030007150	S.CER C1608 CH 1H 151J-T	T	190.1/32
C5309	4030006880	S.CER C1608 JB 1H 472K-T	T	190.1/34.6
C5310	4030007010	S.CER C1608 CH 1H 100D-T	T	197.1/31.7
C5311	4030006880	S.CER C1608 JB 1H 472K-T	T	205.8/30.6
C5312	4510008970	S.ELE EEEHB1C100R	T	207.8/34.5
C5313	4030006880	S.CER C1608 JB 1H 472K-T	T	203.8/30.1
C5314	4030006880	S.CER C1608 JB 1H 472K-T	T	204.5/26.5
C5315	4030006880	S.CER C1608 JB 1H 472K-T	T	205.8/26.5
C5351	4030006880	S.CER C1608 JB 1H 472K-T	T	203.2/23.2
C5352	4030006880	S.CER C1608 JB 1H 472K-T	T	195/19.4
C5353	4030006880	S.CER C1608 JB 1H 472K-T	T	203/19.3
C5354	4030010000	S.CER C1608 CH 1H 510J-T	T	193.7/19.4
C5355	4030006960	S.CER C1608 CH 1H 050C-T	T	190.7/20.7
C5356	4030010000	S.CER C1608 CH 1H 510J-T	T	187.8/19.4
C5357	4030006880	S.CER C1608 JB 1H 472K-T	T	184.6/19.4
C5401	4030011600	S.CER C1608 JB 1E 104K-T	T	196.9/44
C5402	4030006860	S.CER C1608 JB 1H 102K-T	T	196.9/45.3
C5403	4030006900	S.CER C1608 JB 1H 103K-T	T	198.8/45.8
C5404	4030006880	S.CER C1608 JB 1H 472K-T	T	196.6/46.6
C5408	4550005980	S.TAN TEESVA 1A 475M8R	T	199/50.9
C5521	4610001830	S.TRI TZB4S100AB10R00 (TZBX4N100BA110)	T	145.6/72
C5522	4030007130	S.CER C1608 CH 1H 101J-T	T	143.8/66.8
C5523	4030007010	S.CER C1608 CH 1H 100D-T	T	139.6/69.5
C5524	4030006880	S.CER C1608 JB 1H 472K-T	T	144.7/65.4
C5525	4030006870	S.CER C1608 JB 1H 222K-T	T	138/63.2
C5526	4030009510	S.CER C1608 CH 1H 010B-T	T	141.6/65.3
C5528	4030006860	S.CER C1608 JB 1H 102K-T	T	144.5/68.5
C5529	4030011340	S.CER C1608 CH 1H 471J-T	T	140.5/72.2
C5551	4550005980	S.TAN TEESVA 1A 475M8R	T	187.1/49.6
C5552	4550003250	S.TAN TEESVA 1V 474M8R	T	181.6/49.7
C5556	4030006860	S.CER C1608 JB 1H 102K-T	T	150.1/75
C5557	4030011600	S.CER C1608 JB 1E 104K-T	T	148.8/75
C5558	4510009370	ELE 16 ME 470 CZ	T	129.7/72.2
C5560	4510009320	S.ELE EEEHBJ0220R	T	137.9/73.7
C5561	4030011340	S.CER C1608 CH 1H 471J-T	T	176.2/70
C5601	4030006880	S.CER C1608 JB 1H 472K-T	T	175.5/64.7
C5602	4030006860	S.CER C1608 JB 1H 102K-T	T	182.3/66.9
C5603	4030006880	S.CER C1608 JB 1H 472K-T	T	178.5/60.7
C5604	4030006880	S.CER C1608 JB 1H 472K-T	T	184.5/70.6
C5605	4030006880	S.CER C1608 JB 1H 472K-T	T	187.3/68.4
C5606	4030006860	S.CER C1608 JB 1H 102K-T	T	186.4/63.2
C5607	4030006880	S.CER C1608 JB 1H 472K-T	T	187.2/70.6
C5608	4030006880	S.CER C1608 JB 1H 472K-T	T	190.4/63.8
C5609	4030007090	S.CER C1608 CH 1H 470J-T	T	192.2/66.2
C5610	4030011280	S.CER C1608 CH 1H 271J-T	T	193.1/64
C5611	4030007090	S.CER C1608 CH 1H 470J-T	T	194.3/70.9
C5612	4030007060	S.CER C1608 CH 1H 270J-T	T	195.7/64
C5613	4030007020	S.CER C1608 CH 1H 120J-T	T	195.6/70.9
C5614	4030007060	S.CER C1608 CH 1H 270J-T	T	198/66.2
C5615	4030006980	S.CER C1608 CH 1H 070D-T	T	200/69.1
C5616	4030007040	S.CER C160		

[PLL UNIT]

REF NO.	PARTS NO.	DESCRIPTION	M.	H/V LOCATION
C5810	4030006860	S.CER C1608 JB 1H 102K-T	T	46.2/61.6
C5811	4030007010	S.CER C1608 CH 1H 100D-T	T	46.7/64.2
C5812	4030018960	S.CER C3216 JB 1C 106MT-N	T	41.3/69.2
C5881	4030008920	S.CER C1608 JB 1H 473K-T	T	13.2/65.8
C5882	4030007020	S.CER C1608 CH 1H 120J-T	T	18.2/63.9
C5883	4030011600	S.CER C1608 JB 1E 104K-T	T	19.3/57.9
C5884	4030006880	S.CER C1608 JB 1H 472K-T	T	17.1/54.4
C5885	4030006980	S.CER C1608 CH 1H 070D-T	T	21.7/52.8
C5886	4030009500	S.CER C1608 CH 1H 0R5B-T	T	21.7/50.1
C5887	4030006980	S.CER C1608 CH 1H 070D-T	T	23.1/53.1
C5888	4030009510	S.CER C1608 CH 1H 010B-T	T	25.3/52.4
C5889	4030011770	S.CER C1608 CH 1H 060B-T	T	27.5/52
C5890	4030006880	S.CER C1608 JB 1H 472K-T	T	8.2/62
C5891	4030011600	S.CER C1608 JB 1E 104K-T	T	16.9/61.3
C5892	4030011600	S.CER C1608 JB 1E 104K-T	T	11/69.5
C5893	4030007150	S.CER C1608 CH 1H 151J-T	T	5.6/59.7
C5901	4030006880	S.CER C1608 JB 1H 472K-T	T	33.9/42.4
C5902	4030006880	S.CER C1608 JB 1H 472K-T	T	35.7/26.9
C5903	4030006880	S.CER C1608 JB 1H 472K-T	T	37.2/42.4
C5904	4030006880	S.CER C1608 JB 1H 472K-T	T	45/30.5
C5905	4030006880	S.CER C1608 JB 1H 472K-T	T	44.2/35.8
C5906	4030006880	S.CER C1608 JB 1H 472K-T	T	44.2/33.1
C5907	4030006880	S.CER C1608 JB 1H 472K-T	T	39.5/25.6
C5908	4510008970	S.ELE EEEHB1C100R	T	45.6/26.8
C5909	4030006880	S.CER C1608 JB 1H 472K-T	T	41.8/43
C5910	4030006860	S.CER C1608 JB 1H 102K-T	T	46.8/38
C5911	4030007010	S.CER C1608 CH 1H 100D-T	T	46.8/42.1
C5981	4030011600	S.CER C1608 JB 1E 104K-T	T	18.7/27.4
C5982	4030007020	S.CER C1608 CH 1H 120J-T	T	23.4/26.7
C5983	4030009520	S.CER C1608 CH 1H 020B-T	T	23.4/24
C5984	4030007050	S.CER C1608 CH 1H 220J-T	T	25.5/27.5
C5985	4030009530	S.CER C1608 CH 1H 030B-T	T	25.5/26.2
C5986	4030009990	S.CER C1608 CH 1H 200J-T	T	27.5/26.8
J5001	6510022581	S.CON 24FMM-BMTRR-A-TBT(LF)(SN)	T	78/6.5

[PA UNIT]

REF NO.	PARTS NO.	DESCRIPTION	M.	H/V LOCATION
IC6501	1110005450	S.IC TS522IDT	T	112.5/15.7
IC6601	1180001251	S.IC TA7808F(TE16L,Q)	T	119.9/77.5
Q6101	1560001241	S.FET RD01MUS1-T113	T	169.9/48.1
Q6401	1590003040	TRA SD1487		
Q6402	1590003040	TRA SD1487		
Q6403	1540000501	TRA 2SD1585-AZ K		
Q6601	1510001040	S.TRA 2SA1037AKT146S	T	143.8/68.6
Q6602	1590000680	S.TRA DTC114EUA T106	T	139.5/72.7
Q6701	1590000680	S.TRA DTC114EUA T106	T	151.3/27.2
Q6801	1590003051	S.FET PD55003-E	T	158/58
D6701	1160000140	S.DIO DAP222 TL	T	151.5/29.9
L6101	6200003840	S.COI MLF2012D R22K-T	T	179/45.5
L6102	6180000990	COI LAL 04NA 101K		
L6202	6180001240	COI LAL 04NA 820K		
L6204	2040000490	COI EXC-ELDR25C		
L6301	6140003720	COI LR-416 <KN>		
L6303	2040000490	COI EXC-ELDR25C		
L6401	2040000490	COI EXC-ELDR25C		
L6402	2040000490	COI EXC-ELDR25C		
L6403	2040000490	COI EXC-ELDR25C		
L6404	6140003590	COI LR-400 (TR10X5X5 6H3)		
L6405	6140003350	COI LR-376		
L6406	6190001710	COI SK-10M-15X2Y		
L6407	2040000490	COI EXC-ELDR25C		
L6408	6110001730	COI LA-262		
L6501	6200003261	S.COI NLV32T-101J	T	101/13.5
L6701	6200003590	S.COI EXCCL3225U1	T	113.2/6.5
L6702	6200002041	S.COI NLV25T-101J	T	85/9.2
L6703	6200003241	S.COI NLV32T-221J	T	179.7/24.5
L6704	6200003241	S.COI NLV32T-221J	T	175.2/15.2
L6705	6200008820	S.COI HF70ACC 635050-T	T	180/31.6
L6706	6200003241	S.COI NLV32T-221J	T	172.3/10.9
L6707	6200003950	S.COI HF50ACC 322513-T	T	88.3/13.3
L6708	6200003950	S.COI HF50ACC 322513-T	T	80.3/6.3
R6101	7030003270	S.RES ERJ3GEYJ 390 V (39)	T	178.7/42.5
R6102	7030003350	S.RES ERJ3GEYJ 181 V (180)	T	180.6/41.8
R6103	7030003350	S.RES ERJ3GEYJ 181 V (180)	T	180.6/43.3
R6104	7030003300	S.RES ERJ3GEYJ 680 V (68)	T	174.6/47.1
R6105	7030003480	S.RES ERJ3GEYJ 222 V (2.2K)	T	176.4/47.6
R6106	7030003520	S.RES ERJ3GEYJ 472 V (4.7K)	T	174.6/49.7
R6107	7030003420	S.RES ERJ3GEYJ 681 V (680)	T	173.3/49.7
R6109	7030003400	S.RES ERJ3GEYJ 471 V (470)	T	172.4/51.6
R6110	7030000210	S.RES MCR10EZJH 39 (390)	T	171.8/54.5
R6111	7030000210	S.RES MCR10EZJH 39 (390)	T	171.3/56.3
R6112	7030000210	S.RES MCR10EZJH 39 (390)	T	171.2/58
R6201	7030000250	S.RES MCR10EZJH 82 (820)	T	164.7/50.6
R6202	7030003510	S.RES ERJ3GEYJ 392 V (3.9K)	T	164.2/46.5
R6203	7030003520	S.RES ERJ3GEYJ 472 V (4.7K)	T	165/48.4
R6204	7030010800	S.RES ERJ1TYJ 2R7U (2.7)	T	153.7/45.1
R6206	7030000340	S.RES MCR10EZJH 470 (471)	T	152.7/71.5
R6301	7030000260	S.RES MCR10EZJH 100 (101)	T	146.2/48.5
R6302	7030003480	S.RES ERJ3GEYJ 222 V (2.2K)	T	146.7/44
R6303	7030003450	S.RES ERJ3GEYJ 122 V (1.2K)	T	146.7/42.5
R6304	7310005640	S.TRI TMC3ADC3X (3.3K)	T	149.5/40
R6401	7030010260	S.RES ERJ1TYJ 3R3 U	T	92.5/17.5
R6402	7030010260	S.RES ERJ1TYJ 3R3 U	T	92.5/21.5
R6403	7030010260	S.RES ERJ1TYJ 3R3 U	T	93/25.5
R6404	7030010260	S.RES ERJ1TYJ 3R3 U	T	92.5/72.5
R6405	7030010260	S.RES ERJ1TYJ 3R3 U	T	92.5/68.5
R6406	7030010260	S.RES ERJ1TYJ 3R3 U	T	92.9/64.5
R6407	7030001010	S.RES MCR50JZHJ 10 (100)	T	82.8/31.5
R6408	7030001010	S.RES MCR50JZHJ 10 (100)	T	82.7/56.9
R6409	7070000371	RES ERX2SJ 2R2 (2.2)		
R6410	7070000371	RES ERX2SJ 2R2 (2.2)		
R6411	7070000521	RES ERX3SJ 2R7 (2.7)		
R6412	7310005600	S.TRI TMC3ADC3X (2.2K)	T	127.9/20.6
R6413	7030000300	S.RES MCR10EZJH 220 (221)	T	132.8/19
R6502	7030005981	S.RES ERA3YED 333V (33K)	T	119.7/13.2
R6503	7030005981	S.RES ERA3YED 333V (33K)	T	118.7/16.7
R6504	7030005971	S.RES ERA3YKD 683V (68K)	T	120.5/19.7
R6505	7030005971	S.RES ERA3YKD 683V (68K)	T	117.5/18.2
R6507	7030003840	S.RES ERJ3GEYJ 225 V (2.2M)	T	116.7/13
R6509	7030003320	S.RES ERJ3GEYJ 101 V (100)	T	114.5/12.2
R6513	7030003740	S.RES ERJ3GEYJ 334 V (330K)	T	107.7/15.6
R6515	7030003520	S.RES ERJ3GEYJ 472 V (4.7K)	T	103.9/13.9
R6516	7310005540	S.TRI TMC3ADC14X (10K)	T	116.2/23.4
R6518	7030003680	S.RES ERJ3GEYJ 104 V (100K)	T	103/18.5
R6602	7030003520	S.RES ERJ3GEYJ 472 V (4.7K)	T	140.6/70.8
R6603	7030003520	S.RES ERJ3GEYJ 472 V (4.7K)	T	140.5/68.6
R6604	7030003580	S.RES ERJ3GEYJ 153 V (15K)	T	137.3/71.8
R6651	7120000510	RES LR20DT10 5LO(5J)		
R6652	7120000510	RES LR20DT10 5LO(5J)		
R6653	7120000510	RES LR20DT10 5LO(5J)		
R6654	7120000510	RES LR20DT10 5LO(5J)		
R6702	7030003520	S.RES ERJ3GEYJ 472 V (4.7K)	T	61.7/7.7
R6704	7030003480	S.RES ERJ3GEYJ 222 V (2.2K)	T	64.5/7
R6801	7030003410	S.RES ERJ3GEYJ 561 V (560)	T	156.2/67.5
R6802	7030004050	S.RES ERJ3GEYJ 1R0 V (1)	T	167.2/57.5
C6101	4030007090	S.CER C1608 CH 1H 470J-T	T	176.4/43.4
C6102	4030007090	S.CER C1608 CH 1H 470J-T	T	176.4/45
C6103	4030011600	S.CER C1608 JB 1E 104K-T	T	176.4/46.3
C6104	4030011600	S.CER C1608 JB 1E 104K-T	T	176.4/48.9
C6105	4030011600	S.CER C1608 JB 1E 104K-T	T	173.3/47.1
C6106	4030011600	S.CER C1608 JB 1E 104K-T	T	176.4/50.4
C6108	4030011600	S.CER C1608 JB 1E 104K-T	T	166.4/46.4

M.=Mounted side (T: Mounted on the Top side, B: Mounted on the Bottom side)  
S.=Surface mount

[PA UNIT]

REF NO.	PARTS NO.	DESCRIPTION	M.	H/V LOCATION
C6109	4030005110	S.CER C2012 JB 1E 473K-T	T	175.6/53
C6201	4030011600	S.CER C1608 JB 1E 104K-T	T	167/50.1
C6202	4030011600	S.CER C1608 JB 1E 104K-T	T	162.9/47.6
C6203	4030004750	S.CER C2012 JB 1H 103K-T	T	158.5/47
C6205	4030008700	S.CER GRM21BB11H473KA01L (GRM40 B)	T	149.7/48
C6206	4030008700	S.CER GRM21BB11H473KA01L (GRM40 B)	T	145.5/74.2
C6301	4030008960	S.CER C2012 JB 1C 104K-T	T	147.2/52.7
C6302	4030011600	S.CER C1608 JB 1E 104K-T	T	146.7/45.5
C6303	4510009370	ELE 16 ME 470 CZ		
C6305	4030011600	S.CER C1608 JB 1E 104K-T	T	110.3/60.2
C6306	4510006640	ELE 16 ME 1000 CZ		
C6307	4320001210	S.MIC UC552H 6800J-T	T	123.2/42.7
C6308	4030011790	S.CER GRM55RF52A684ZD01L (GRM44-1)	T	123.4/57.1
C6401	4030011760	S.CER GRM55R1X2D682JV01L (GRM44-1)	T	93/33.5
C6403	4030011760	S.CER GRM55R1X2D682JV01L (GRM44-1)	T	93/56.5
C6408	4030018370	S.CER ERF22X 6C1H 102J D01L	T	63.2/44.9
C6409	4030018370	S.CER ERF22X 6C1H 102J D01L	T	66.5/44.9
C6410	4030018230	S.CER ERF22X 6C2D 221JD		
C6412	4510006640	ELE 16 ME 1000 CZ		
C6413	4510006640	ELE 16 ME 1000 CZ		
C6414	4030004740	S.CER C2012 JB 1H 472K-T	T	3.6/19
C6415	4030011790	S.CER GRM55RF52A684ZD01L (GRM44-1)	T	16.7/21.3
C6416	4030008920	S.CER C1608 JB 1H 473K-T	T	125/24.5
C6417	4510006640	ELE 16 ME 1000 CZ		
C6418	4030006880	S.CER C1608 JB 1H 472K-T	T	125/23.2
C6419	4030006880	S.CER C1608 JB 1H 472K-T	T	131.2/12
C6424	4030018370	S.CER ERF22X 6C1H 102J D01L	T	93.4/45
C6425	4320001210	S.MIC UC552H 6800J-T		
C6427	4030011600	S.CER C1608 JB 1E 104K-T	T	149/24.5
C6428	4030011600	S.CER C1608 JB 1E 104K-T	T	83.7/81.3
C6432	4030011740	S.CER GRM32N2C2H201JV01L (GRM42-2 CH)	T	60.9/13.3
C6433	4030011740	S.CER GRM32N2C2H201JV01L (GRM42-2 CH)	T	59.2/78.8
C6501	4030007130	S.CER C1608 CH 1H 101J-T	T	116.7/16
C6503	4030011600	S.CER C1608 JB 1E 104K-T	T	111.2/12.2
C6602	4030006880	S.CER C1608 JB 1H 472K-T	T	139.1/68.6
C6603	4510009370	ELE 16 ME 470 CZ		
C6604	4510009330	S.ELE EEEHA1E470WP	T	104.5/72.5
C6605	4030011600	S.CER C1608 JB 1E 104K-T	T	109.7/76
C6606	4030011600	S.CER C1608 JB 1E 104K-T	T	109.7/79
C6607	4510009330	S.ELE EEEHA1E470WP	T	104.7/80.2
C6608	4030008700	S.CER GRM21BB11H473KA01L (GRM40 B)	T	55.1/6.7
C6609	4510009390	ELE 16 ME 2200 CZ		
C6610	4030017320	S.CER GRM21BB11H104KA01L (GRM40-034)	T	7.8/77.8
C6611	4030004740	S.CER C2012 JB 1H 472K-T	T	7.8/75.5
C6612	4030004720	S.CER C2012 JB 1H 102K-T	T	10.5/79.2
C6701	4030008920	S.CER C1608 JB 1H 473K-T	T	149.1/30.6
C6702	4030008920	S.CER C1608 JB 1H 473K-T	T	59.8/8.4
C6703	4030008920	S.CER C1608 JB 1H 473K-T	T	64.5/5.5
C6704	4030006880	S.CER C1608 JB 1H 472K-T	T	85.6/11.2
C6705	4030006880	S.CER C1608 JB 1H 472K-T	T	110.2/6.5
C6706	4030006880	S.CER C1608 JB 1H 472K-T	T	165.5/6.1
C6707	4030006880	S.CER C1608 JB 1H 472K-T	T	171.7/16.1
C6708	4030006880	S.CER C1608 JB 1H 472K-T	T	176.7/24.6
C6710	4030006880	S.CER C1608 JB 1H 472K-T	T	176.5/27.3
C6711	4030006880	S.CER C1608 JB 1H 472K-T	T	168.2/10
C6712	4030006880	S.CER C1608 JB 1H 472K-T	T	163.5/6.7
C6713	4030006880	S.CER C1608 JB 1H 472K-T	T	167.3/6.8
C6714	4030006880	S.CER C1608 JB 1H 472K-T	T	163.5/5.4
C6715	4030006880	S.CER C1608 JB 1H 472K-T	T	168.2/8.1
C6716	4030007130	S.CER C1608 CH 1H 101J-T	T	169.6/10.3
C6717	4030007130	S.CER C1608 CH 1H 101J-T	T	177.9/27.3
C6718	4030007130	S.CER C1608 CH 1H 101J-T	T	171.7/14.7
C6719	4030007130	S.CER C1608 CH 1H 101J-T	T	176.8/21.6
C6801	4030011600	S.CER C1608 JB 1E 104K-T	T	159/67.5
RL6701	6330001471	REL AJS1311F-K2		
J6301	6510021531	CON IMSA-9230B-1-04Z024-PT1		
J6302	6510021531	CON IMSA-9230B-1-04Z024-PT1		
J6401	6510007020	CON TMP-J01X-V6		
J6411	6510021391	CON IMSA-9230B-1-03Z024-PT1		
J6412	6510021391	CON IMSA-9230B-1-03Z024-PT1		
J6701	6510022541	S.CON 20FMM-BMTTR-A-TBT(LF)(SN)	T	98/8.1
J6702	6510007020	CON TMP-J01X-V6		
J6703	6510003401	CON B04B-EH-S(LF)(SN)		
F6701	5210000061	FUS FGB 5A PBF (FGB0 125V)		
F6702	5220000230	HOL S-N5054 #01		
F6703	5220000230	HOL S-N5054 #01		
S6701	6910006900	THE OHD-3 110M		
W6601	9062700030	WIR 77/98/040/X98/X98		
EP6601	6910000630	BEA FSRH070140RN000B (FSOH070RN)		
EP6602	6510018330	TER F4053A		
EP6603	6510018330	TER F4053A		

[PA UNIT]

REF NO.	PARTS NO.	DESCRIPTION	M.	H/V LOCATION
EP6701	6910012350	S.BEA MMZ1608Y 102BT	T	95.6/12
EP6702	6910012350	S.BEA MMZ1608Y 102BT	T	94.9/13.3
EP6703	6910012350	S.BEA MMZ1608Y 102BT	T	97.6/13.5
EP6704	6910012350	S.BEA MMZ1608Y 102BT	T	84.7/7.3
EP6705	6910012350	S.BEA MMZ1608Y 102BT	T	103.3/16.4
EP6706	6910012350	S.BEA MMZ1608Y 102BT	T	162.9/9.8
EP6707	6910012350	S.BEA MMZ1608Y 102BT	T	165.6/10.1
EP6708	6910012350	S.BEA MMZ1608Y 102BT	T	164.3/9.8
EP6709	6910012350	S.BEA MMZ1608Y 102BT	T	86.6/5.5
EP6710	6910012350	S.BEA MMZ1608Y 102BT	T	166.9/10.1

M.=Mounted side (T: Mounted on the Top side, B: Mounted on the Bottom side)  
S.=Surface mount

**[DRIVER UNIT]**

REF NO.	PARTS NO.	DESCRIPTION	M.	H/V LOCATION
Q6851	1590003061	S.FET PD55015-E	T	9.7/20
R6851 R6852	7030010520 7030000020	S.RES ERJ1TYJ 101U (100) S.RES MCR10EZJH 1 (010)	T T	1.95/15.4 1.95/15.4
C6851	4030004750	S.CER C2012 JB 1H 103K-T	T	14.1/14.1
MP6851	8410002480	S.HEA 2429 PA HEATSINK	B	9.7/20

**[VARISTOR-1 UNIT]**

REF NO.	PARTS NO.	DESCRIPTION	M.	H/V LOCATION
D6431	1790001760	S.VAR MA30-(TX)	T	3.4/13.5
C6431	4030008920	S.CER C1608 JB 1H 473K-T	T	3.7/11.7

M.=Mounted side (T: Mounted on the Top side, B: Mounted on the Bottom side)  
S.=Surface mount

[VARISTOR-2 UNIT]

REF NO.	PARTS NO.	DESCRIPTION	M.	H/V LOCATION
D6432	1790001760	S.VAR MA30-(TX)	T	3.7/13.6
C6432	4030008920	S.CER C1608 JB 1H 473K-T	T	3.8/11.7

[FILTER UNIT]

REF NO.	PARTS NO.	DESCRIPTION	M.	H/V LOCATION
W7321	8970024710	CBL 1.5D 360MM (1958 FI W7321)		
Q7301	1590000680	S.TRA DTC114EUA T106	B	139.2/88.4
D7271	1750000191	S.DIO 1SS322(TE85R,F)	B	161.2/81.9
D7272	1750000191	S.DIO 1SS322(TE85R,F)	B	161.2/85.5
D7301	1750000550	S.DIO 1SS355 TE-17	B	136.2/92.4
L7031	6200002041	S.COI NLV25T-101J	B	156.5/59.6
L7035	6200002041	S.COI NLV25T-101J	B	148.5/4.5
L7036	6140002240	COI LR-236 (T68-2)		
L7037	6140001990	COI LR-226 (T68-2)		
L7038	6140002000	COI LR-227 (T68-2)		
L7061	6200002041	S.COI NLV25T-101J	B	115.4/64.3
L7065	6200002041	S.COI NLV25T-101J	B	128.2/14.9
L7066	6140002340	COI LR-263 (T68-2)		
L7067	6140002230	COI LR-235 (T68-2)		
L7068	6140002240	COI LR-236 (T68-2)		
L7091	6200002041	S.COI NLV25T-101J	B	96.1/83.8
L7095	6200002041	S.COI NLV25T-101J	B	110.9/15.5
L7096	6140002260	COI LR-238 (T68-2)		
L7097	6140002230	COI LR-235 (T68-2)		
L7098	6140002230	COI LR-235 (T68-2)		
L7121	6200002041	S.COI NLV25T-101J	B	79.7/80.8
L7125	6200002041	S.COI NLV25T-101J	B	96.2/16
L7126	6140002260	COI LR-238 (T68-2)		
L7127	6140002340	COI LR-263 (T68-2)		
L7128	6140002340	COI LR-263 (T68-2)		
L7151	6200005051	S.COI NLV25T-330J	B	64.5/82.4
L7155	6200005051	S.COI NLV25T-330J	B	75/16.8
L7156	6140002280	COI LR-241 (T68-6)		
L7157	6140002250	COI LR-237 (T68-2)		
L7158	6140002250	COI LR-237 (T68-2)		
L7181	6200005051	S.COI NLV25T-330J	B	50.4/89.7
L7182	6140003580	COI LR-399(3.5%)		
L7183	6140003570	COI LR-398 (3.5%)		
L7184	6140003570	COI LR-398 (3.5%)		
L7185	6200005051	S.COI NLV25T-330J	B	57.9/17.6
L7211	6200005011	S.COI NLV25T-100J	B	47.3/89
L7215	6200005011	S.COI NLV25T-100J	B	23.1/30.4
L7216	6140003570	COI LR-398 (3.5%)		
L7217	6140003570	COI LR-398 (3.5%)		
L7218	6140003570	COI LR-398 (3.5%)		
L7241	6200005011	S.COI NLV25T-100J	B	6.3/75.3
L7244	6200005011	S.COI NLV25T-100J	B	16.6/30.5
L7245	6140003780	COI LR-437		
L7246	6140003780	COI LR-437		
L7248	6140003780	COI LR-437		
L7271	6200002041	S.COI NLV25T-101J	B	170.9/80.5
L7272	6140003490	COI LR-391 (TR10X5X5 3A6)		
L7273	6200002041	S.COI NLV25T-101J	B	170.9/87.6
L7321	6140001460	COI LR-170		
L7331	6200002041	S.COI NLV25T-101J	B	24.5/4.6
L7332	6200002041	S.COI NLV25T-101J	B	24.4/10.6
R7271	7030003560	S.RES ERJ3GEYJ 103 V (10K)	B	167.5/81.6
R7272	7030003490	S.RES ERJ3GEYJ 272 V (2.7K)	B	166.7/79.4
R7273	7030003520	S.RES ERJ3GEYJ 472 V (4.7K)	B	163.9/79.4
R7274	7030008190	S.RES ERJ12YJ330U (33)	B	155.4/83.7
R7275	7030003560	S.RES ERJ3GEYJ 103 V (10K)	B	167.5/85.8
R7276	7030003490	S.RES ERJ3GEYJ 272 V (2.7K)	B	166.7/88.8
R7277	7030003520	S.RES ERJ3GEYJ 472 V (4.7K)	B	163.9/88.8
R7301	7030003200	S.RES ERJ3GEYJ 100 V (10)	B	131.3/95.5
R7314	7540000250	ABS SA05C 401N		
R7315	7030010650	S.RES ERJ12YJ823U (82K)	B	159.1/99.4
C7031	4510009360	ELE 50 ME 1 CZ		
C7032	4030011600	S.CER C1608 JB 1E 104K-T	B	148.9/6.5
C7033	4320001220	S.MIC UC552H 1001J-T	B	157.6/18.8
C7034	4010006410	CER HM13SJ SL 471J 500V		
C7035	4010006410	CER HM13SJ SL 471J 500V		
C7036	4320001220	S.MIC UC552H 1001J-T	B	164.4/32.5
C7037	4010005360	CER HM11SJ SL 301J 500V		
C7038	4010005880	CER HM95SJ SL 271J 500V		
C7039	4320001230	S.MIC UC552H 1201J-T	B	161.8/39.2
C7041	4030011120	S.CER GRM31M2C2H100JV01L (GRM42-6 CH)	B	178.5/42.5
C7042	4010005930	CER HM11SJ SL 391J 500V		
C7043	4010005930	CER HM11SJ SL 391J 500V		
C7044	4010005930	CER HM11SJ SL 391J 500V		
C7045	4010005370	CER HM11SJ SL 331J 500V		
C7046	4030011600	S.CER C1608 JB 1E 104K-T	B	159.1/60.6
C7049	4010005850	CER HM95SJ SL 181J 500V		
C7050	4320001230	S.MIC UC552H 1201J-T	B	160.7/26.2
C7051	4320001230	S.MIC UC552H 1201J-T	B	166.5/45.7
C7052	4030011740	S.CER GRM32N2C2H201JV01L (GRM42-2 CH)	B	170/50.7
C7061	4510009360	ELE 50 ME 1 CZ		
C7062	4030011600	S.CER C1608 JB 1E 104K-T	B	128.6/16.8
C7063	4030011730	S.CER GRM31M2C2H101JV01L (GRM42-6 CH)	B	144.2/25.7
C7064	4010006410	CER HM13SJ SL 471J 500V		
C7065	4010006410	CER HM13SJ SL 471J 500V		
C7066	4010005370	CER HM11SJ SL 331J 500V		
C7067	4010005880	CER HM95SJ SL 271J 500V		
C7068	4010005880	CER HM95SJ SL 271J 500V		
C7069	4010005880	CER HM95SJ SL 271J 500V		
C7070	4030011730	S.CER GRM31M2C2H101JV01L (GRM42-6 CH)	B	156/30.5
C7071	4010006410	CER HM13SJ SL 471J 500V		

M.=Mounted side (T: Mounted on the Top side, B: Mounted on the Bottom side)  
S.=Surface mount

[FILTER UNIT]

REF NO.	PARTS NO.	DESCRIPTION	M.	H/V LOCATION
C7072	4010006410	CER HM13SJ SL 471J 500V		
C7073	4010006410	CER HM13SJ SL 471J 500V		
C7074	4010006410	CER HM13SJ SL 471J 500V		
C7075	4010005370	CER HM11SJ SL 331J 500V		
C7076	4010005370	CER HM11SJ SL 331J 500V		
C7077	4010005370	CER HM11SJ SL 331J 500V		
C7078	4010005930	CER HM11SJ SL 391J 500V		
C7079	4010006410	CER HM13SJ SL 471J 500V		
C7080	4030012480	S.CER GRM31M2C2H121JV01L (GRM42-6 CH)	B	128.4/48.6
C7081	4030012480	S.CER GRM31M2C2H121JV01L (GRM42-6 CH)	B	125.7/48.6
C7082	4010005930	CER HM11SJ SL 391J 500V		
C7083	4010005930	CER HM11SJ SL 391J 500V		
C7084	4030011550	S.CER GRM31M2C2H680JV01L (GRM42-6 CH)	B	138.1/55.1
C7085	4030011600	S.CER C1608 JB 1E 104K-T	B	118.3/61.9
C7086	4030011120	S.CER GRM31M2C2H100JV01L (GRM42-6 CH)	B	144.2/28.3
C7087	4030012480	S.CER GRM31M2C2H121JV01L (GRM42-6 CH)	B	152.3/29
C7091	4510009360	ELE 50 ME 1 CZ	B	111/17.5
C7092	4030006880	S.CER C1608 JB 1H 472K-T		
C7094	4010005370	CER HM11SJ SL 331J 500V		
C7095	4010005930	CER HM11SJ SL 391J 500V		
C7096	4010005930	CER HM11SJ SL 391J 500V		
C7098	4010005370	CER HM11SJ SL 331J 500V		
C7099	4010006410	CER HM13SJ SL 471J 500V		
C7100	4030011730	S.CER GRM31M2C2H101JV01L (GRM42-6 CH)	B	106.6/67.2
C7101	4010005360	CER HM11SJ SL 301J 500V		
C7102	4030006880	S.CER C1608 JB 1H 472K-T	B	102.8/85.3
C7105	4010006410	CER HM13SJ SL 471J 500V		
C7106	4010005830	CER HM74SJ SL 151J 500V		
C7108	4010005370	CER HM11SJ SL 331J 500V		
C7121	4510009360	ELE 50 ME 1 CZ		
C7122	4030006880	S.CER C1608 JB 1H 472K-T	B	93.6/17.5
C7124	4030012480	S.CER GRM31M2C2H121JV01L (GRM42-6 CH)	B	82/29.4
C7125	4010005930	CER HM11SJ SL 391J 500V		
C7126	4030011120	S.CER GRM31M2C2H100JV01L (GRM42-6 CH)	B	85.1/41.7
C7127	4030012480	S.CER GRM31M2C2H121JV01L (GRM42-6 CH)	B	82.5/41.7
C7128	4010005880	CER HM95SJ SL 271J 500V		
C7129	4010005360	CER HM11SJ SL 301J 500V		
C7130	4030011510	S.CER GRM31M2C2H560JV01L (GRM42-6 CH)	B	86.8/67.2
C7131	4030011070	S.CER GRM31M2C2H5R0CY21L (GRM42-6 CH)	B	86.8/64.6
C7132	4010005360	CER HM11SJ SL 301J 500V		
C7133	4030006880	S.CER C1608 JB 1H 472K-T	B	85.4/79.6
C7136	4010005850	CER HM95SJ SL 181J 500V		
C7137	4030011730	S.CER GRM31M2C2H101JV01L (GRM42-6 CH)	B	93.2/28.9
C7151	4510009360	ELE 50 ME 1 CZ		
C7152	4030006880	S.CER C1608 JB 1H 472K-T	B	74/18.7
C7153	4030014460	S.CER GRM31M2C2H820JV01L (GRM42-6 CH)	B	69.2/39.8
C7154	4010005930	CER HM11SJ SL 391J 500V		
C7155	4030012480	S.CER GRM31M2C2H121JV01L (GRM42-6 CH)	B	72.5/55.1
C7156	4030011120	S.CER GRM31M2C2H100JV01L (GRM42-6 CH)	B	74.6/55.1
C7157	4010005930	CER HM11SJ SL 391J 500V		
C7158	4030014460	S.CER GRM31M2C2H820JV01L (GRM42-6 CH)	B	73.2/67.8
C7160	4030006880	S.CER C1608 JB 1H 472K-T	B	67.8/79.5
C7163	4010005850	CER HM95SJ SL 181J 500V		
C7164	4030014460	S.CER GRM31M2C2H820JV01L (GRM42-6 CH)	B	65.8/28.6
C7181	4510009360	ELE 50 ME 1 CZ		
C7182	4030006880	S.CER C1608 JB 1H 472K-T	B	63.3/18.7
C7183	4030012480	S.CER GRM31M2C2H121JV01L (GRM42-6 CH)	B	62.6/24.8
C7184	4030012480	S.CER GRM31M2C2H121JV01L (GRM42-6 CH)	B	53.1/28.8
C7185	4010005880	CER HM95SJ SL 271J 500V		
C7186	4030011510	S.CER GRM31M2C2H560JV01L (GRM42-6 CH)	B	53.1/40.6
C7187	4010005370	CER HM11SJ SL 331J 500V		
C7188	4030011180	S.CER GRM31M2C2H220JV01L (GRM42-6 CH)	B	50.6/68.8
C7190	4030006880	S.CER C1608 JB 1H 472K-T	B	51/85
C7193	4010005850	CER HM95SJ SL 181J 500V		
C7211	4510009360	ELE 50 ME 1 CZ		
C7212	4030006880	S.CER C1608 JB 1H 472K-T	B	25.7/35.3
C7214	4030011240	S.CER GRM31M2C2H470JV01L (GRM42-6 CH)	B	35.6/61.7
C7216	4030011190	S.CER GRM31M2C2H270JV01L (GRM42-6 CH)	B	33.1/75.9
C7217	4030012480	S.CER GRM31M2C2H121JV01L (GRM42-6 CH)	B	29/77.3
C7218	4030006880	S.CER C1608 JB 1H 472K-T	B	44/85.3
C7221	4030014460	S.CER GRM31M2C2H820JV01L (GRM42-6 CH)	B	30.7/45.2
C7222	4010005860	CER HM95SJ SL 201J 500V		
C7223	4030014460	S.CER GRM31M2C2H820JV01L (GRM42-6 CH)	B	30.7/47.4
C7224	4030011210	S.CER GRM31M2C2H330JV01L (GRM42-6 CH)	B	30.3/65.8
C7225	4030011190	S.CER GRM31M2C2H270JV01L (GRM42-6 CH)	B	30.7/42.9
C7241	4030006880	S.CER C1608 JB 1H 472K-T	B	15.3/35.1

[FILTER UNIT]

REF NO.	PARTS NO.	DESCRIPTION	M.	H/V LOCATION
C7242	4030011730	S.CER GRM31M2C2H101JV01L (GRM42-6 CH)	B	9.2/46.6
C7243	4030011510	S.CER GRM31M2C2H560JV01L (GRM42-6 CH)	B	9.2/48.9
C7244	4030011180	S.CER GRM31M2C2H220JV01L (GRM42-6 CH)	B	8.8/57.7
C7247	4030011190	S.CER GRM31M2C2H270JV01L (GRM42-6 CH)	B	16.3/65.6
C7248	4030011210	S.CER GRM31M2C2H330JV01L (GRM42-6 CH)	B	24.7/60.6
C7249	4030011230	S.CER GRM31M2C2H390JV01L (GRM42-6 CH)	B	24.2/65.8
C7250	4030006880	S.CER C1608 JB 1H 472K-T	B	9.1/80.1
C7253	4010005830	CER HM74SJ SL 151J 500V		
C7254	4030011180	S.CER GRM31M2C2H220JV01L (GRM42-6 CH)	B	8.8/55.6
C7255	4030011080	S.CER GRM31M2C2H6R0DV01L (GRM42-6 CH)	B	8.5/44.3
C7272	4030006900	S.CER C1608 JB 1H 103K-T	B	159/80.3
C7273	4030007090	S.CER C1608 CH 1H 470J-T	B	165.4/86.1
C7274	4030006870	S.CER C1608 JB 1H 222K-T	B	159/87.1
C7275	4610001340	TRI ECR-LA010 A12		
C7277	4010005850	CER HM95SJ SL 181J 500V		
C7278	4030007090	S.CER C1608 CH 1H 470J-T	B	163.2/81.3
C7301	4030006880	S.CER C1608 JB 1H 472K-T	B	136.3/90.7
C7302	4030006880	S.CER C1608 JB 1H 472K-T	B	139.2/86.2
C7303	4030006880	S.CER C1608 JB 1H 472K-T	B	137.1/88.4
C7304	4030006880	S.CER C1608 JB 1H 472K-T	B	129.4/99.2
C7321	4030011730	S.CER GRM31M2C2H101JV01L (GRM42-6 CH)	B	163.9/74
C7322	4030011170	S.CER GRM31M2C2H180JV01L (GRM42-6 CH)	B	166.9/69.3
C7323	4030011730	S.CER GRM31M2C2H101JV01L (GRM42-6 CH)	B	169.7/74
C7325	4030011790	S.CER GRM55RF52A684ZD01L (GRM44-1)	B	155.1/72.6
C7332	4030006880	S.CER C1608 JB 1H 472K-T	B	22.1/10.5
C7345	4030006880	S.CER C1608 JB 1H 472K-T	B	27.1/11.7
RL7031	6330001571	REL AJS1315F-K1		
RL7032	6330001571	REL AJS1315F-K1		
RL7061	6330001571	REL AJS1315F-K1		
RL7062	6330001571	REL AJS1315F-K1		
RL7091	6330001571	REL AJS1315F-K1		
RL7092	6330001571	REL AJS1315F-K1		
RL7121	6330001571	REL AJS1315F-K1		
RL7122	6330001571	REL AJS1315F-K1		
RL7151	6330001571	REL AJS1315F-K1		
RL7152	6330001571	REL AJS1315F-K1		
RL7181	6330001571	REL AJS1315F-K1		
RL7182	6330001571	REL AJS1315F-K1		
RL7211	6330001571	REL AJS1315F-K1		
RL7212	6330001571	REL AJS1315F-K1		
RL7241	6330001571	REL AJS1315F-K1		
RL7242	6330001571	REL AJS1315F-K1		
RL7301	6330000781	REL AGP2013F		
J7001	6510007020	CON TMP-J01X-V6		
J7311	6510007020	CON TMP-J01X-V6		
J7331	6510022561	CON 16FMN-BTRK-A(LF)(SN)		

M.=Mounted side (T: Mounted on the Top side, B: Mounted on the Bottom side)  
S.=Surface mount

[REG-DC UNIT]

REF NO.	PARTS NO.	DESCRIPTION	M.	H/V LOCATION
IC301	1110003071	S.IC UPC494GS-E1-A	T	19.1/202.5
IC302	1180002261	S.IC TA78L12F(TE12L,F)	T	40.5/208.2
IC401	1190002250	S.IC TLP131(GB-TPL,F)	T	49.4/111.9
IC402	1190002220	S.IC TLP141G(U,F)	T	55.7/112
IC403	1110001241	S.IC UPC358G2-E1-A	T	54/69
Q101	1590003610	FET STP120NF10		
Q102	1590003610	FET STP120NF10		[EUR-1] only
Q103	1590003610	FET STP120NF10		[EUR-1] only
Q104	1590003610	FET STP120NF10		
Q301	1510000801	S.TRA 2SA1213-Y(TE12R,CF)	T	36.4/192.7
Q302	1510000801	S.TRA 2SA1213-Y(TE12R,CF)	T	37.7/200
Q401	1510000771	S.TRA 2SA1586-GR(TE85L,F)	T	50.8/91.7
D101	1710001230	DIO S3V60-5000		
D102	1730002431	S.ZEN MAZ8150GML	T	37.2/196.2
D103	1730002431	S.ZEN MAZ8150GML	T	38.4/203.4
D201	1710001220	DIO MUR3020WTG		
D202	1710001220	DIO MUR3020WTG		
D203	1790001491	DIO D1NL20U-5070		
D301	1750000291	S.DIO 1S5300(TE85R,F)	T	40.7/192.1
D302	1750000291	S.DIO 1S5300(TE85R,F)	T	41.9/199.4
D303	1790001251	S.DIO MA2S1110GL	T	18.2/214.3
D304	1790001251	S.DIO MA2S1110GL	T	18.2/212.8
D401	1730002321	S.ZEN MAZ8051GML	T	50.4/102.6
D402	1790001251	S.DIO MA2S1110GL	T	48.4/102.4
D403	1790001251	S.DIO MA2S1110GL	T	50.4/99.2
D404	1790001251	S.DIO MA2S1110GL	T	48.4/99.2
D405	1730002321	S.ZEN MAZ8051GML	T	55.3/62.5
D406	1790001251	S.DIO MA2S1110GL	T	49.1/96.7
D407	1790001251	S.DIO MA2S1110GL	T	51.7/97.5
L101	6190001670	COI FK-230N-1020H		
L102	6190001670	COI FK-230N-1020H		[EUR-1] only
L201	6190001700	COI HD3535-1928V		
L202	6140004630	COI LR-522		
L203	6140004630	COI LR-522		
L221	6910000670	COI BL01RN1A1D2B (BL01RN1-A62)		
L222	6910000670	COI BL01RN1A1D2B (BL01RN1-A62)		
R101	7030003720	S.RES ERJ3GEYJ 224 V (220K)	T	172.2/81.2
R102	7070000321	RES ERX1SJ 3R3 (3.3)		
R103	7070000321	RES ERX1SJ 3R3 (3.3)		
R104	7070000251	RES ERX2SJ 4R7 (4.7)		
R105	7070000251	RES ERX2SJ 4R7 (4.7)		
R106	7070000321	RES ERX1SJ 3R3 (3.3)		
R107	7070000321	RES ERX1SJ 3R3 (3.3)		
R108	7070000681	RES ERX3SJ 3R9 (3.9)		
	7070000900	RES ERX3SJ 1R8 (1.8)		[EUR-1]
R201	7070000601	RES ERG2SJ 470 (47)		
R202	7070000601	RES ERG2SJ 470 (47)		
R203	7070000601	RES ERG2SJ 470 (47)		
R204	7120000510	RES LR20DT10 5L0(5J)		
R205	7120000510	RES LR20DT10 5L0(5J)		
R301	7030003440	S.RES ERJ3GEYJ 102 V (1K)	T	32.4/191.9
R302	7030003440	S.RES ERJ3GEYJ 102 V (1K)	T	33.3/199.2
R303	7030007591	S.RES ERA3YKD 433V (43K)	[EUR]	12.4/203.6
	7030003570	S.RES ERJ3GEYJ 123 V (12K)	[EUR-1]	
R304	7030006111	S.RES ERA3YED 752V (7.5K)	[EUR]	10.7/200.3
	7030003520	S.RES ERJ3GEYJ 472 V (4.7K)	[EUR-1]	
R305	7030003320	S.RES ERJ3GEYJ 101 V (100)	T	18.9/208.4
R306	7030003520	S.RES ERJ3GEYJ 472 V (4.7K)	T	12.4/206.8
R307	7030003520	S.RES ERJ3GEYJ 472 V (4.7K)	T	10.7/206.8
R308	7030003440	S.RES ERJ3GEYJ 102 V (1K)	T	16.3/208.3
R309	7030003620	S.RES ERJ3GEYJ 333 V (33K)	T	18.2/211.4
R310	7030003490	S.RES ERJ3GEYJ 272 V (2.7K)	T	23/196.7
R311	7030003480	S.RES ERJ3GEYJ 222 V (2.2K)	T	18.5/195.5
R312	7030003610	S.RES ERJ3GEYJ 273 V (27K)	T	55.7/120.2
R313	7030003720	S.RES ERJ3GEYJ 224 V (220K)	T	48.2/118.2
R314	7030003550	S.RES ERJ3GEYJ 822 V (8.2K)	[EUR]	11.5/208.9
	7030003860	S.RES ERJ3GE JPW V	[EUR-1]	
R315	7030003390	S.RES ERJ3GEYJ 391 V (390)	[EUR]	10.7/203.6
	7030003450	S.RES ERJ3GEYJ 122 V (1.2K)	[EUR-1]	
R316	7030003340	S.RES ERJ3GEYJ 151 V (150)	[EUR]	39.6/195.1
	7030003200	S.RES ERJ3GEYJ 100 V (10)	[EUR-1]	
R317	7030003340	S.RES ERJ3GEYJ 151 V (150)	[EUR]	40.9/202.3
	7030003200	S.RES ERJ3GEYJ 100 V (10)	[EUR-1]	
R401	7030003430	S.RES ERJ3GEYJ 821 V (820)	T	48.1/105.9
R402	7030003520	S.RES ERJ3GEYJ 472 V (4.7K)	T	50.2/62.9
R403	7030003720	S.RES ERJ3GEYJ 224 V (220K)	T	52.5/63.7
R404	7030003480	S.RES ERJ3GEYJ 222 V (2.2K)	T	52.5/62.2
R405	7030003420	S.RES ERJ3GEYJ 681 V (680)	T	52.4/106.6
R406	7030003520	S.RES ERJ3GEYJ 472 V (4.7K)	T	54.8/106.8
R407	7030003450	S.RES ERJ3GEYJ 122 V (1.2K)	T	57.5/62.2
R408	7030003760	S.RES ERJ3GEYJ 474 V (470K)	T	52/74.4
R409	7030003520	S.RES ERJ3GEYJ 472 V (4.7K)	T	47.8/74.4
R410	7030003620	S.RES ERJ3GEYJ 333 V (33K)	T	56.6/74.5
R411	7030003400	S.RES ERJ3GEYJ 471 V (470)	T	57.1/65.1
R412	7030003380	S.RES ERJ3GEYJ 331 V (330)	T	52.9/76.6
R414	7030003530	S.RES ERJ3GEYJ 562 V (5.6K)	T	39/47
R415	7310005600	S.TRI TMC3ADCJ3X (2.2K)	T	39/43.8
R416	7030003500	S.RES ERJ3GEYJ 332 V (3.3K)	T	39/40.2
R418	7520000120	POS PTFM04BC222Q2N34B0 (PTH9M04 BC)		
R419	7030003640	S.RES ERJ3GEYJ 473 V (47K)	T	56.2/96.4
R420	7310005530	S.TRI TMC3ADC32X (470)	T	55.7/79.7
C101	4310000860	MYL 50 F2D 474J		
C102	4510007351	ELE 35 ME 1000 AX		
C103	4310000860	MYL 50 F2D 474J		

[REG-DC UNIT]

REF NO.	PARTS NO.	DESCRIPTION	M.	H/V LOCATION
C104	4310000860	MYL 50 F2D 474J		
C105	4510008451	ELE 35 ME 2200 AX		
C107	4340000320	S.MYL ECHU1H473JC9	T	119.3/188
C108	4340000320	S.MYL ECHU1H473JC9	T	123.2/202.5
C110	4340000330	S.MYL ECHU1H103J	T	116/188.9
C111	4340000330	S.MYL ECHU1H103J	T	126.3/201.7
C112	4510007351	ELE 35 ME 1000 AX		
C113	4510007351	ELE 35 ME 1000 AX		
C114	4510007351	ELE 35 ME 1000 AX		
C115	4340000340	S.MYL ECWU1103JX5	T	64.9/172.2
C116	4340000340	S.MYL ECWU1103JX5	T	88.4/172.2
C117	4310001210	MYL 250 MMB 473K		
C118	4510007351	ELE 35 ME 1000 AX		
C119	4510007351	ELE 35 ME 1000 AX		
C120	4510007351	ELE 35 ME 1000 AX		
C121	4560000150	CER RPEE12A105ZAQ1E04B (RPE210E105Z)		
C122	4560000150	CER RPEE12A105ZAQ1E04B (RPE210E105Z)		
C123	4510009490	ELE 35 ME 470 HWN	[EUR-1] only	
C201	4340000340	S.MYL ECWU1103JX5	T	74.1/35.2
C202	4340000340	S.MYL ECWU1103JX5	T	78.3/40.4
C203	4340000340	S.MYL ECWU1103JX5	T	85.5/40.4
C204	4510009180	ELE 25 ME 2700 AX		
C205	4510009180	ELE 25 ME 2700 AX		
C206	4510009180	ELE 25 ME 2700 AX		
C207	4340000330	S.MYL ECHU1H103J	T	48.4/12.9
C208	4340000330	S.MYL ECHU1H103J	T	53.8/21.8
C209	4510009180	ELE 25 ME 2700 AX		
C210	4510009180	ELE 25 ME 2700 AX		
C211	4510009180	ELE 25 ME 2700 AX		
C212	4340000350	S.MYL ECWU1C474JC9	T	27.6/22.4
C213	4340000350	S.MYL ECWU1C474JC9	T	8.5/34.4
C301	4340000360	S.MYL ECWU1H104JC9	T	35.5/208.6
C302	4340000360	S.MYL ECWU1H104JC9	T	7.5/201.5
C303	4510007180	ELE 50 ME 47 CZ		
C304	4340000330	S.MYL ECHU1H103J	T	20.3/194.8
C305	4340000330	S.MYL ECHU1H103J	T	16.5/194.7
C306	4340000250	S.MYL ECHU 1C 104JX5	T	13.4/194.7
C307	4510008970	S.ELE EEEHB1C100R	T	12.4/212.9
C308	4340000330	S.MYL ECHU1H103J	T	55.7/118.3
C401	4340000250	S.MYL ECHU 1C 104JX5	T	52/59.7
C402	4340000380	S.MYL ECHU1C473JX5	T	48.6/77
C403	4510009330	S.ELE EEEHA1E470WP	T	47.4/69.1
C404	4510008970	S.ELE EEEHB1C100R	T	55.2/102.9
C405	4510009290	S.ELE EEEHB1H1R0R	T	43.4/44
C407	4340000250	S.MYL ECHU 1C 104JX5	T	54/91.3
RL101	6330001830	REL ALF1P12		
RL102	6330001830	REL ALF1P12		
RL103	6330001830	REL ALF1P12		[EUR-1] only
J101	6510004981	CON RTB-1.5-4F(LF)		
F101	5210000061	FUS FGB 5A PBF (FGB0 125V)		
F102	5220000230	HOL S-N5054 #01		
F103	5220000230	HOL S-N5054 #01		
T101	5910001040	TRA TP-75 (24V)	[EUR]	
	5910001030	TRA TP-74 (12V)	[EUR-1]	
EP101	6910010910	TER PB-3-S		
EP102	6910010910	TER PB-3-S		
EP104	6910018630	E.O 4PB-12		
EP105	6910010910	TER PB-3-S		
EP106	6910010910	TER PB-3-S		
EP107	6910018630	E.O 4PB-12		
EP201	6910011330	TER OT-009 M3		
EP202	6910011330	TER OT-009 M3		
EP205	6910011330	TER OT-009 M3		
EP206	6910010910	TER PB-3-S		
EP207	6910011330	TER OT-009 M3		
EP418	9029702901	TUB IRRAX TUBE 0.7 L=8MM		

M.=Mounted side (T: Mounted on the Top side, B: Mounted on the Bottom side) S.=Surface mount





[DSP UNIT]

REF NO.	PARTS NO.	DESCRIPTION	M.	H/V LOCATION
C203	4030011600	S.CER C1608 JB 1E 104K-T	B	54.5/31.2
C301	4030006880	S.CER C1608 JB 1H 472K-T	T	55.1/27.1
C302	4030006880	S.CER C1608 JB 1H 472K-T	T	55.1/29.7
C303	4030011600	S.CER C1608 JB 1E 104K-T	T	55.1/32.3
C304	4030006880	S.CER C1608 JB 1H 472K-T	T	55.1/34.9
C305	4030011600	S.CER C1608 JB 1E 104K-T	T	55.1/37.5
C306	4030011600	S.CER C1608 JB 1E 104K-T	T	55.1/40.1
C307	4030011600	S.CER C1608 JB 1E 104K-T	T	48.1/19.2
C308	4030011600	S.CER C1608 JB 1E 104K-T	T	45.4/19.2
C309	4030006880	S.CER C1608 JB 1H 472K-T	T	42.1/18.9
C311	4030006880	S.CER C1608 JB 1H 472K-T	T	39.3/18.9
C312	4030011600	S.CER C1608 JB 1E 104K-T	T	36.3/18.9
C313	4030011600	S.CER C1608 JB 1E 104K-T	T	49.4/47.2
C314	4030006880	S.CER C1608 JB 1H 472K-T	T	47.5/48.1
C315	4030011600	S.CER C1608 JB 1E 104K-T	T	44.2/47.5
C316	4030006880	S.CER C1608 JB 1H 472K-T	T	41.6/47.3
C317	4030011600	S.CER C1608 JB 1E 104K-T	T	39/47.2
C318	4030006880	S.CER C1608 JB 1H 472K-T	T	36.4/47.2
C319	4030006880	S.CER C1608 JB 1H 472K-T	T	32.9/47.2
C320	4030011600	S.CER C1608 JB 1E 104K-T	T	27.1/25.3
C321	4030011600	S.CER C1608 JB 1E 104K-T	T	27.1/28.9
C322	4030006880	S.CER C1608 JB 1H 472K-T	T	27.1/31.5
C323	4030011600	S.CER C1608 JB 1E 104K-T	T	27.1/34.1
C324	4030006880	S.CER C1608 JB 1H 472K-T	T	27.1/36.7
C325	4030006880	S.CER C1608 JB 1H 472K-T	T	27.1/39.3
C401	4030006880	S.CER C1608 JB 1H 472K-T	T	18.6/28
C403	4030006880	S.CER C1608 JB 1H 472K-T	B	22.9/43.9
C404	4030006880	S.CER C1608 JB 1H 472K-T	B	23/33
C405	4030006880	S.CER C1608 JB 1H 472K-T	B	15.4/18
C406	4030006880	S.CER C1608 JB 1H 472K-T	T	17/8.2
C407	4030006860	S.CER C1608 JB 1H 102K-T	B	24.2/43.1
C408	4030006860	S.CER C1608 JB 1H 102K-T	B	24/7.6
C504	4510009300	S.ELE EEEHB1H2R2R	T	67.3/35.6
C505	4030011600	S.CER C1608 JB 1E 104K-T	T	68/32.1
C506	4550007320	S.TAN F930J226MAABMA	T	62.5/33.2
C507	4030011600	S.CER C1608 JB 1E 104K-T	T	64.9/30.8
C508	4030011600	S.CER C1608 JB 1E 104K-T	T	63.5/19.5
C509	4030011600	S.CER C1608 JB 1E 104K-T	T	63.5/18
C510	4550007320	S.TAN F930J226MAABMA	T	62.3/15.2
C511	4030007050	S.CER C1608 CH 1H 220J-T	B	62.9/25.4
C601	4510008970	S.ELE EEEHB1C100R	T	73/34.1
C602	4030009980	S.CER C1608 JB 1H 152K-T	B	74.4/37.2
C603	4030011600	S.CER C1608 JB 1E 104K-T	B	77.1/38.5
C604	4510008970	S.ELE EEEHB1C100R	T	75.3/40.6
C605	4030011600	S.CER C1608 JB 1E 104K-T	B	70.4/43.3
C606	4510009290	S.ELE EEEHB1H1R0R	T	81.8/41.1
C651	4030009980	S.CER C1608 JB 1H 152K-T	B	74/26.3
C652	4030011600	S.CER C1608 JB 1E 104K-T	B	76.6/27.6
C653	4510008970	S.ELE EEEHB1C100R	T	74.3/27
C654	4030011600	S.CER C1608 JB 1E 104K-T	B	70.4/32.6
C655	4510009290	S.ELE EEEHB1H1R0R	T	78.3/32.1
C701	4030011280	S.CER C1608 CH 1H 271J-T	B	72.3/23
C702	4030007130	S.CER C1608 CH 1H 101J-T	B	72.3/20.4
C703	4030011600	S.CER C1608 JB 1E 104K-T	B	75.8/17.3
C704	4510008970	S.ELE EEEHB1C100R	T	71.8/18.9
C705	4030007130	S.CER C1608 CH 1H 101J-T	B	68.1/19.1
C706	4030011600	S.CER C1608 JB 1E 104K-T	B	66.4/21
C707	4510009340	S.ELE EEEHA1C101WP	T	72.6/12.9
C708	4510008970	S.ELE EEEHB1C100R	T	77.8/22.4
C751	4030011280	S.CER C1608 CH 1H 271J-T	T	66.1/15.5
C752	4030007130	S.CER C1608 CH 1H 101J-T	B	73.1/10.8
C755	4030007130	S.CER C1608 CH 1H 101J-T	B	68.4/12.4
C756	4030011600	S.CER C1608 JB 1E 104K-T	B	65.3/11.1
C757	4510009340	S.ELE EEEHA1C101WP	T	60.6/9.1
C758	4510008970	S.ELE EEEHB1C100R	T	82.2/8.5
C801	4030006880	S.CER C1608 JB 1H 472K-T	B	15.5/5.8
C802	4030006860	S.CER C1608 JB 1H 102K-T	T	33.3/4.4
C901	4030006860	S.CER C1608 JB 1H 102K-T	B	85.9/8.9
J901	6910013900	CON IMSA-9180S-22A		
J902	6910012460	CON IMSA-9180S-30A		
EP2	6910012350	S.BEA MMZ1608Y 102BT	B	51.6/18.6

M.=Mounted side (T: Mounted on the Top side, B: Mounted on the Bottom side)  
S.=Surface mount



• MAIN UNIT  
(BOTTOM VIEW)

The combination of this side and the bottom side shows  
the board layout in the same configuration as the actual  
P.C.Board.

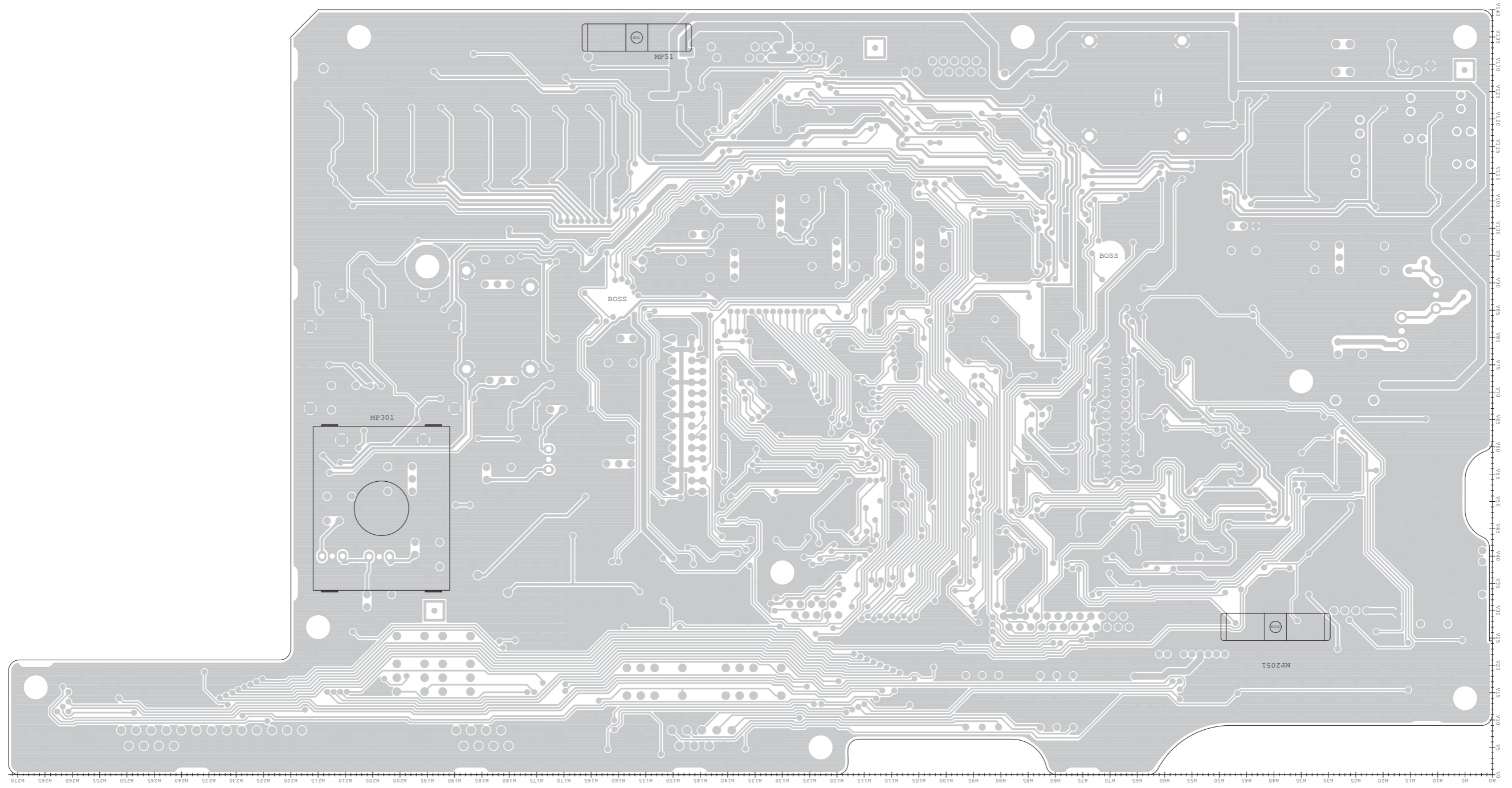



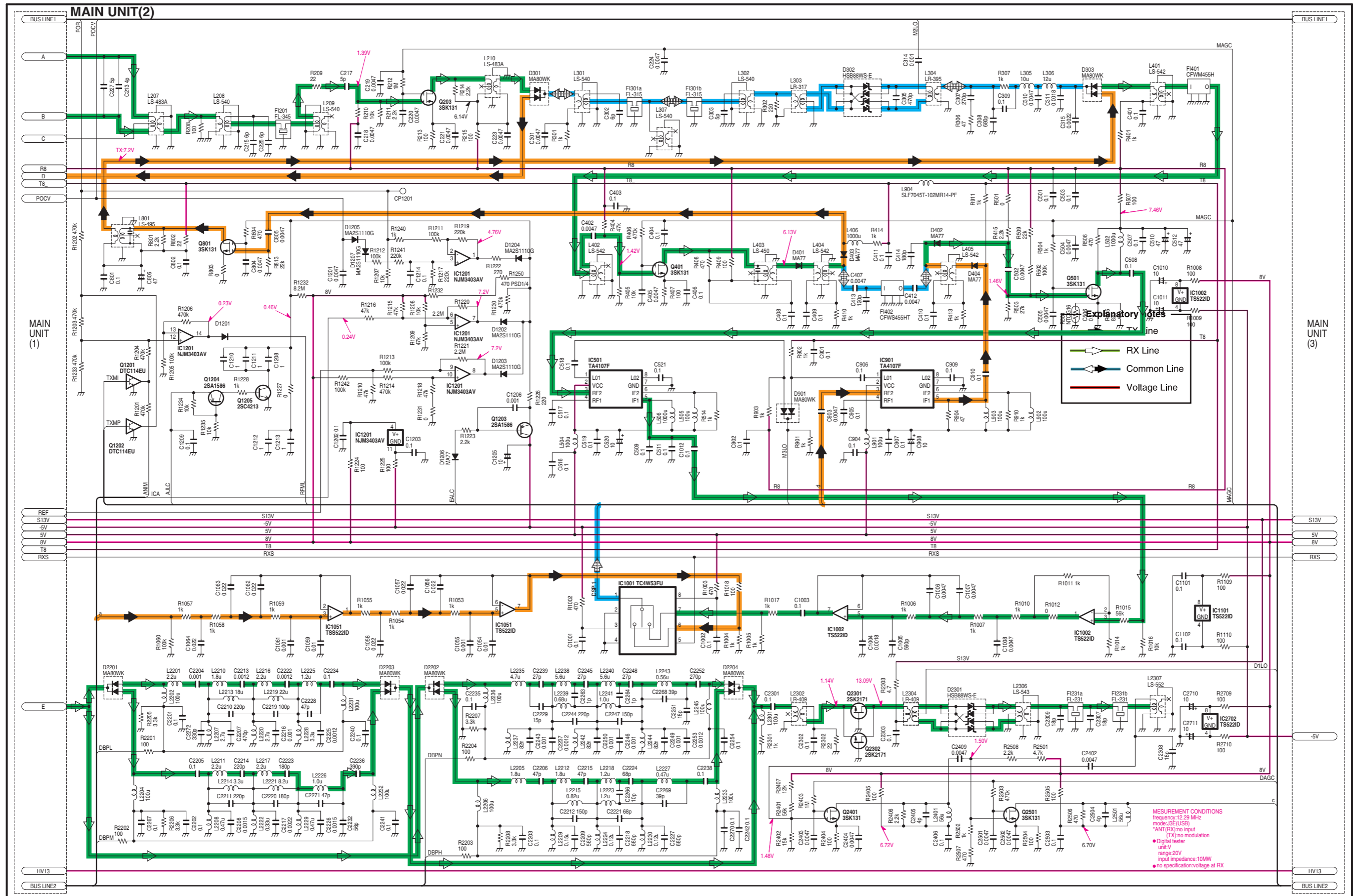

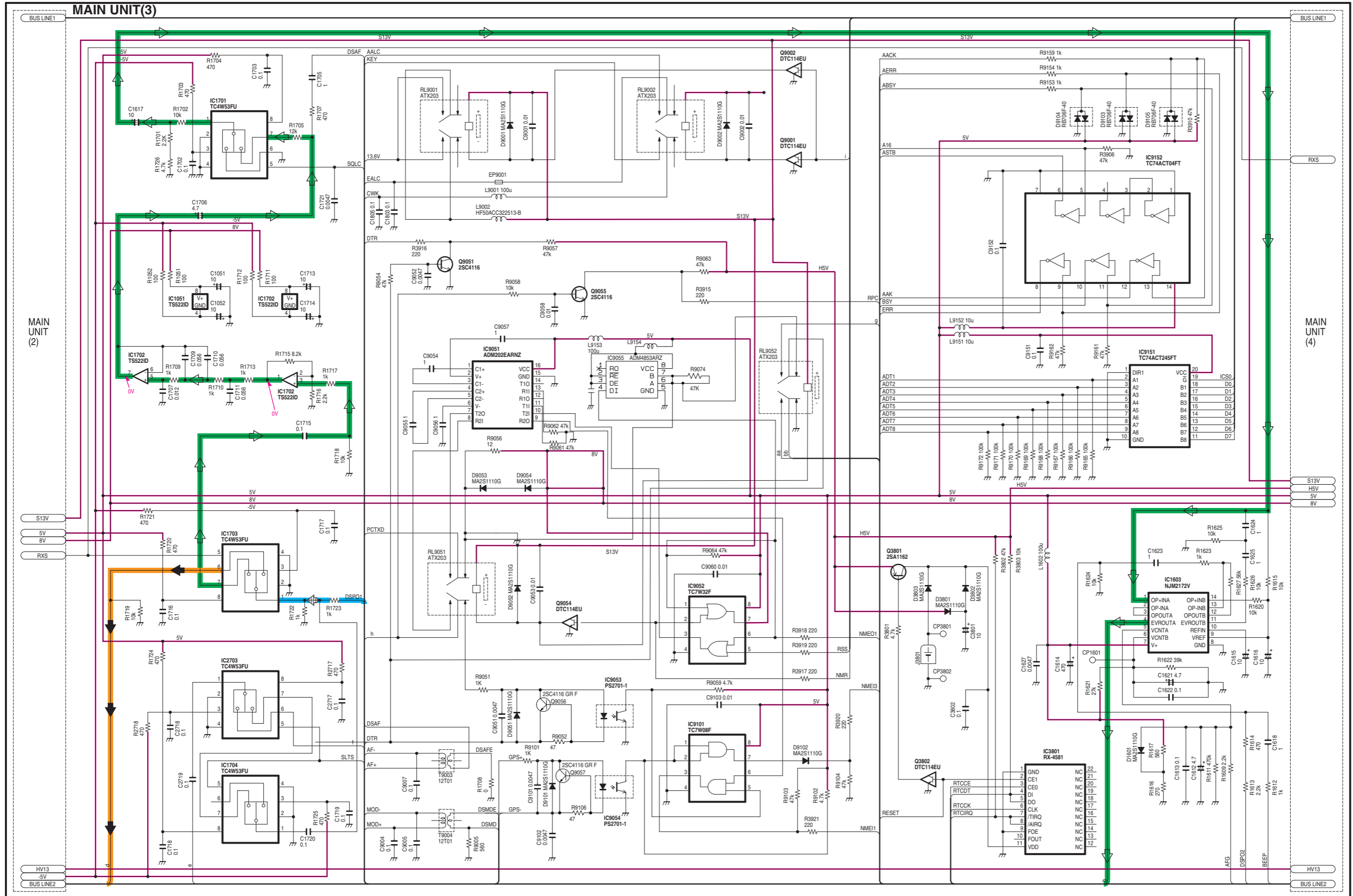

\*; Refer to "PARTS LIST."

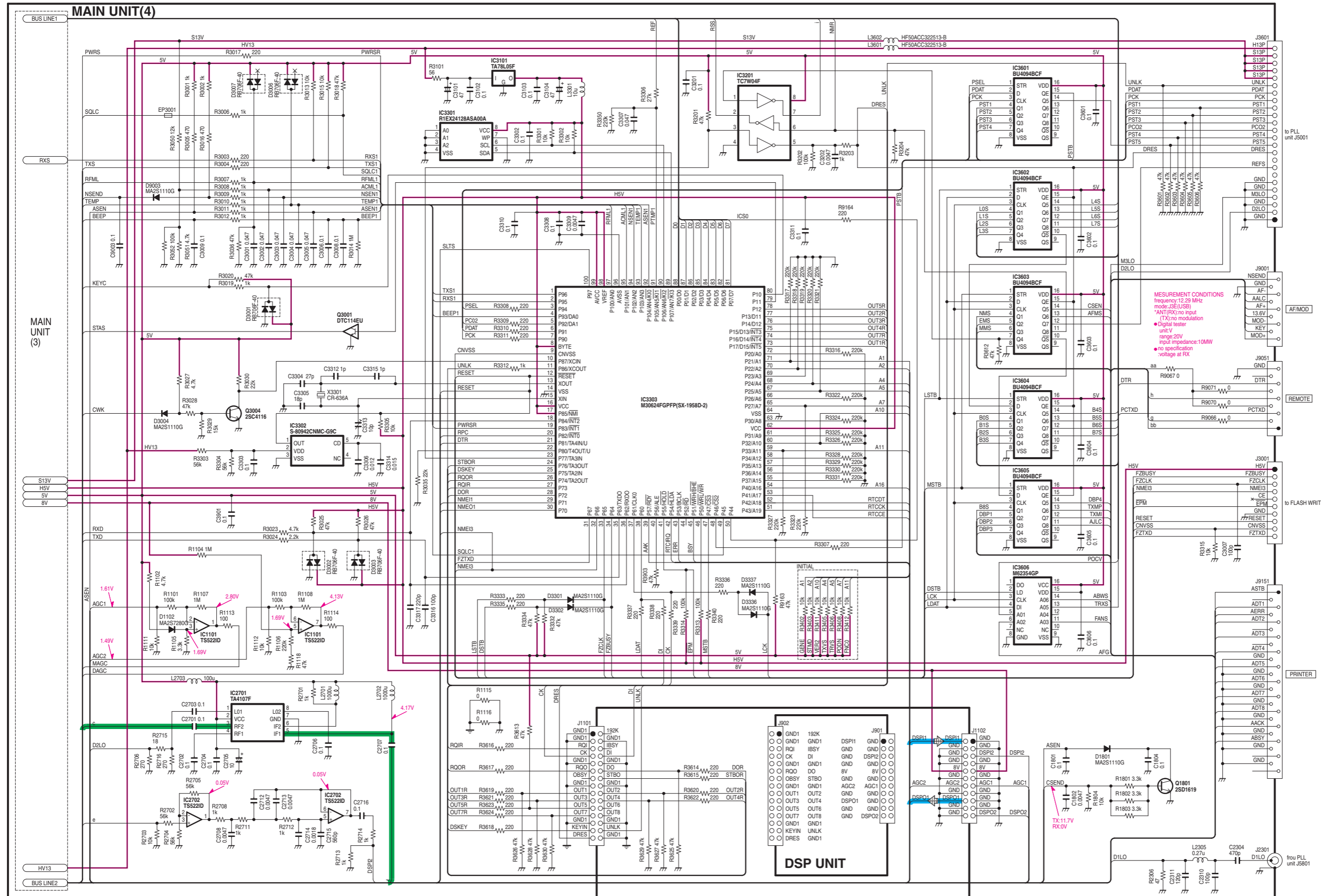

\*, Refer to "PARTS LIST."



DSP UNIT

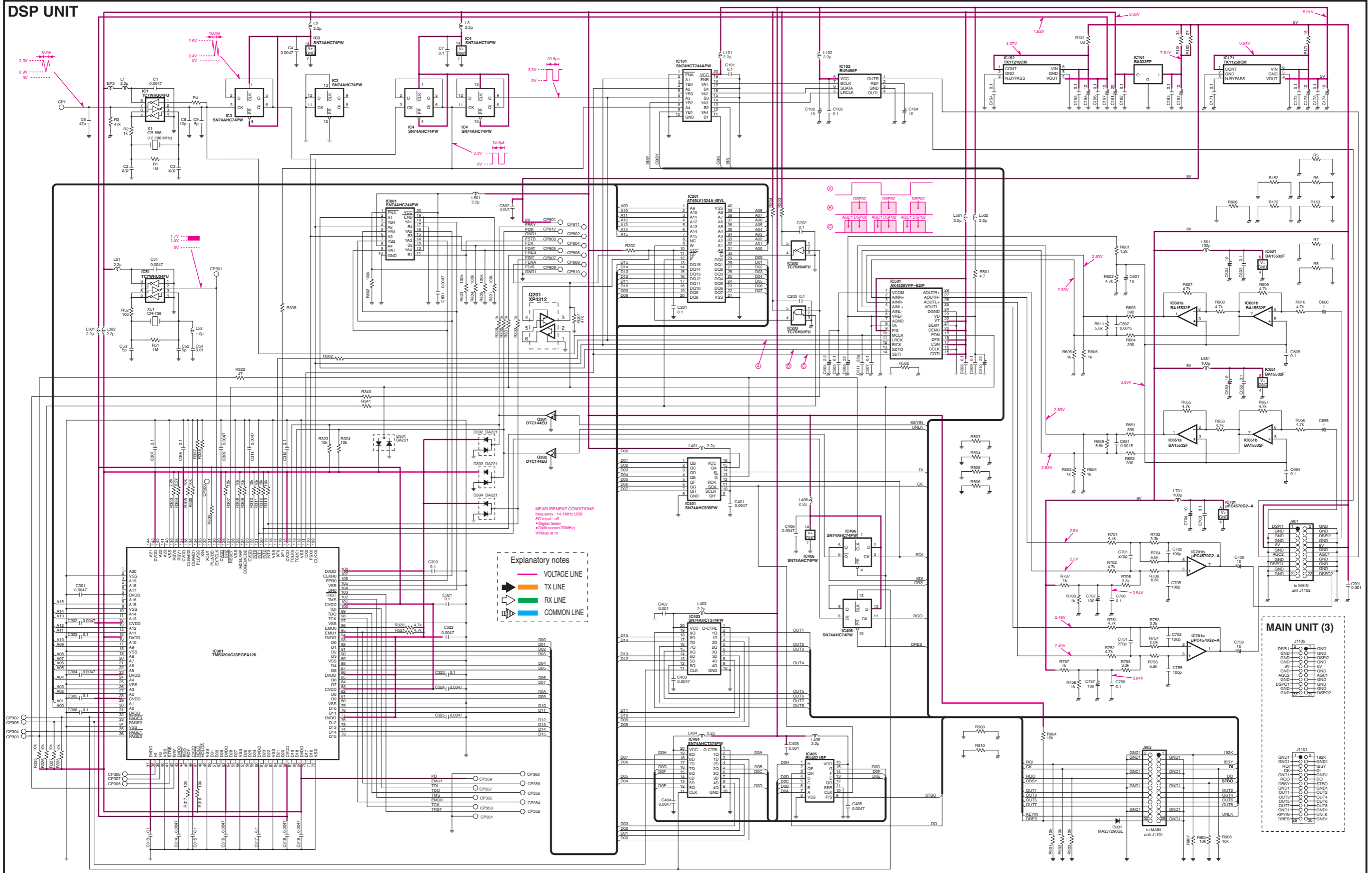

\*; Refer to "PARTS LIST."

Feb. 2009



# SERVICE MANUAL ADDENDUM

---

## IC-M801E

---

### CONTENTS

PARTS LIST .....	1
BOARD LAYOUTS .....	16
VOLTAGE DIAGRAM .....	22

# PARTS LIST

## [MAIN UNIT]

REF NO.	PARTS NO.	DESCRIPTION	M.	H/V LOCATION
IC1	1110006870	S.IC UPC2709TB-E3	T	191.6/133.5
IC501	1110005461	S.IC TA4107F(TE12L,F)	T	91.3/83
IC901	1110005461	S.IC TA4107F(TE12L,F)	T	78.2/83.2
IC1001	1130006221	S.IC TC4W53FU(TE12L,F)	T	77.6/55.9
IC1002	1110005450	S.IC TS521DT	T	90.7/62.5
IC1051	1110005450	S.IC TS521DT	T	74.2/45
IC1101	1110005450	S.IC TS521DT	T	46.1/85.1
IC1201	1110005140	S.IC NJM3403AV-TE1-#ZZZB	T	118.2/115.7
IC1301	1160000131	S.IC TD62783AFG(5,S,EL)	T	98.7/118.2
IC1302	1160000131	S.IC TD62783AFG(5,S,EL)	T	166.8/94.5
IC1303	1160000131	S.IC TD62783AFG(5,S,EL)	T	57.9/109
IC1501	1180000421	S.IC TA78L05F(TE12R,F)	T	9/76.7
IC1502	1180002010	S.REG BA08FF-E2	T	152.4/116.6
IC1551	1110001401	S.IC UPC1555G2-E1-A	T	61/123.7
IC1601	1110003091	IC LA4425A-E	T	
IC1602	1130006221	S.IC TC4W53FU(TE12L,F)	T	21.7/25
IC1603	1110006300	S.IC NJM2172V-TE1-#ZZZB	T	29.1/37.1
IC1701	1130006221	S.IC TC4W53FU(TE12L,F)	T	25.6/58.3
IC1702	1110005450	S.IC TS521DT	T	45.8/46.3
IC1703	1130006221	S.IC TC4W53FU(TE12L,F)	T	76.9/66.6
IC1704	1130006221	S.IC TC4W53FU(TE12L,F)	T	61.8/66.4
IC2001	1130008230	S.IC BU4053BCFV-E2	T	61.3/48.5
IC2701	1110005461	S.IC TA4107F(TE12L,F)	T	40/60.9
IC2702	1110005450	S.IC TS521DT	T	56.8/58.7
IC2703	1130006221	S.IC TC4W53FU(TE12L,F)	T	48.7/59.8
IC3101	1180000421	S.IC TA78L05F(TE12R,F)	T	140.1/26.9
IC3201	1130005721	S.IC TC7W04F(TE12L,F)	T	85.6/41.4
IC3301	1140009241	S.IC R1EX24128ASA00A	T	105.3/77.1
IC3302	1110005771	S.IC S-80942CNMC-G9CT2G	T	104/68.4
IC3303	1140013169	S.IC M30624FGFPF(SX-1958A-9)	T	118.1/63.2
IC3601	1130007700	S.IC BU4094BCF-E2	T	95.8/27.9
IC3602	1130007700	S.IC BU4094BCF-E2	T	99.3/107.8
IC3603	1130007700	S.IC BU4094BCF-E2	T	86.5/48.6
IC3604	1130007700	S.IC BU4094BCF-E2	T	170/84
IC3605	1130007700	S.IC BU4094BCF-E2	T	68.6/108.8
IC3606	1110003690	S.IC M62354GP 75EC	T	67.3/94.2
IC3801	1130011551	S.IC RX-4581NB-F	T	135.8/55.6
IC9051	1120002921	S.IC ADM202EARNZ	T	172.2/16
IC9052	1130007041	S.IC TC7W32F(TE12L,F)	T	208.5/22.7
IC9053	1170000290	S.IC PS2701-1-F3	T	181.6/20.4
IC9054	1170000290	S.IC PS2701-1-F3	T	37.7/22.7
IC9055	1120003060	S.IC ADM4853ARZ-REEL7	T	205.5/13
IC9101	1130006801	S.IC TC7W08F(TE12L,F)	T	51.2/14.9
IC9151	1130012940	S.IC TC74ACT245FT(EL)	T	238.8/15
IC9152	1130012950	S.IC TC74ACT04FT(EL)	T	256/14
Q51	1530003091	S.TRA 2SC4213-B(TE85R,F)	T	163.6/128.3
Q201	1560000721	S.FET 2SK2171-4-TD-E	T	184.4/78.3
Q202	1560000721	S.FET 2SK2171-4-TD-E	T	179.5/81.7
Q203	1580000620	S.FET 3SK131-T2 MAS	T	191.4/54.6
Q401	1580000620	S.FET 3SK131-T2 MAS	T	136.6/102.3
Q501	1580000620	S.FET 3SK131-T2 MAS	T	92.2/96.6
Q601	1530003151	S.TRA 2SC4673D-TD-E	T	201.4/77.5
Q701	1580000620	S.FET 3SK131-T2 MAS	T	204.6/100.4
Q702	1580000620	S.FET 3SK131-T2 MAS	T	212.8/77.5
Q703	1580000620	S.FET 3SK131-T2 MAS	T	207.9/77.5
Q801	1580000620	S.FET 3SK131-T2 MAS	T	132.9/92.7
Q1201	1590000680	S.TRA DTC114EUA T106	T	109.8/112.7
Q1202	1590000680	S.TRA DTC114EUA T106	T	109.8/115.3
Q1203	1510000771	S.TRA 2SA1586-GR(TE85L,F)	T	131.6/114.9
Q1204	1510000771	S.TRA 2SA1586-GR(TE85L,F)	T	138.9/122.3
Q1205	1530003091	S.TRA 2SC4213-B(TE85R,F)	T	136/123.5
Q1501	1540000441	S.TRA 2SD1619T-TD-E	T	83.7/113.3
Q1502	1540000441	S.TRA 2SD1619T-TD-E	T	85.5/120.7
Q1503	1590000680	S.TRA DTC114EUA T106	T	87.7/114.5
Q1504	1590000680	S.TRA DTC114EUA T106	T	88.4/124.5
Q1601	1590000680	S.TRA DTC114EUA T106	T	3.3/25.3
Q1801	1540000441	S.TRA 2SD1619T-TD-E	T	140.6/37.8
Q2101	1590000680	S.TRA DTC114EUA T106	T	41.6/133.4
Q2102	1530002691	S.TRA 2SC4116-GR(TE85R,F)	T	41.6/130.1
Q2301	1560000721	S.FET 2SK2171-4-TD-E	T	36.8/97
Q2302	1560000721	S.FET 2SK2171-4-TD-E	T	36.8/91
Q2401	1580000620	S.FET 3SK131-T2 MAS	T	35.6/79.3
Q2501	1580000620	S.FET 3SK131-T2 MAS	T	43.9/72.8
Q3001	1590000680	S.TRA DTC114EUA T106	T	134/125.8
Q3004	1530002691	S.TRA 2SC4116-GR(TE85R,F)	T	137.4/44.5
Q3801	1510000501	S.TRA 2SA1162-GR(TE85R,F)	T	134/49.7
Q3802	1530002691	S.TRA 2SC4116-GR(TE85R,F)	T	137.3/49.1
Q9001	1590000680	S.TRA DTC114EUA T106	T	127.5/19.7
Q9002	1590000680	S.TRA DTC114EUA T106	T	145.6/19.7
Q9051	1530002691	S.TRA 2SC4116-GR(TE85R,F)	T	163.9/9.2
Q9054	1590000680	S.TRA DTC114EUA T106	T	203.7/21.6
Q9055	1530002691	S.TRA 2SC4116-GR(TE85R,F)	T	163.9/6.6
Q9056	1530002691	S.TRA 2SC4116-GR(TE85R,F)	T	184/16.6
Q9057	1530002691	S.TRA 2SC4116-GR(TE85R,F)	T	30.9/22.4
D51	1750001360	S.DIO L709CER (9401)	T	170.3/132.7
D52	1750001360	S.DIO L709CER (9401)	T	173.1/132.7
D53	1790001770	S.DIO MA80WK-(TX)	T	182.1/133.7
D101	1790001770	S.DIO MA80WK-(TX)	T	171.9/125.1
D102	1790001770	S.DIO MA80WK-(TX)	T	181.6/125.8
D103	1790001770	S.DIO MA80WK-(TX)	T	189.7/125.7
D104	1790001770	S.DIO MA80WK-(TX)	T	204.7/125.8
D105	1790000620	S.DIO MA77(TX)	T	216.6/125.6
D106	1790001770	S.DIO MA80WK-(TX)	T	167.7/108.3
D107	1790001770	S.DIO MA80WK-(TX)	T	181.6/105.7

## [MAIN UNIT]

REF NO.	PARTS NO.	DESCRIPTION	M.	H/V LOCATION
D108	1790001770	S.DIO MA80WK-(TX)	T	192/106.7
D109	1790001770	S.DIO MA80WK-(TX)	T	206.2/106.7
D110	1790000620	S.DIO MA77(TX)	T	216.7/106.9
D201	1790001770	S.DIO MA80WK-(TX)	T	192.8/103.1
D301	1790001770	S.DIO MA80WK-(TX)	T	207.1/54.9
D302	1750000431	S.DIO HSB88WSTR-E	T	160/52.3
D303	1790001770	S.DIO MA80WK-(TX)	T	154.8/72.1
D401	1790000620	S.DIO MA77(TX)	T	127.1/97.2
D402	1790000620	S.DIO MA77(TX)	T	94.8/99.2
D403	1790000620	S.DIO MA77(TX)	T	124/89.9
D404	1790000620	S.DIO MA77(TX)	T	97.1/88.2
D601	1730002281	S.ZEN MAZ8091GML	T	193.4/76.8
D602	1790001770	S.DIO MA80WK-(TX)	T	193.1/72.4
D901	1790001770	S.DIO MA80WK-(TX)	T	82.8/74.5
D1102	1790001241	S.DIO MA2S7280GL	T	46.8/80
D1201	1790001241	S.DIO MA2S7280GL	T	112.6/110.1
D1202	1790001251	S.DIO MA2S1110GL	T	123.4/119.1
D1203	1790001251	S.DIO MA2S1110GL	T	123.5/120.4
D1204	1790001251	S.DIO MA2S1110GL	T	126.3/111.8
D1205	1790001251	S.DIO MA2S1110GL	T	127.7/114.2
D1206	1790000620	S.DIO MA77(TX)	T	139/111
D1207	1790001251	S.DIO MA2S1110GL	T	127.7/115.5
D1501	1790001670	S.DIO RB706F-40T106	T	83.2/117.5
D1502	1790001670	S.DIO RB706F-40T106	T	83.4/124.8
D1551	1730002321	S.ZEN MAZ8051GML	T	65.4/132.9
D1552	1790001670	S.DIO RB706F-40T106	T	70.8/128.5
D1554	1730002281	S.ZEN MAZ8091GML	T	57.2/128.2
D1601	1790001251	S.DIO MA2S1110GL	T	34.5/28.6
D1801	1790001251	S.DIO MA2S1110GL	T	137.5/42.6
D2101	1790001241	S.DIO MA2S7280GL	T	34.9/128.1
D2102	1790001251	S.DIO MA2S1110GL	T	32.1/133.6
D2103	1750001360	S.DIO L709CER (9401)	T	34.6/132.7
D2104	1750001360	S.DIO L709CER (9401)	T	37.4/132.7
D2201	1790001770	S.DIO MA80WK-(TX)	T	32.2/124.1
D2202	1790001770	S.DIO MA80WK-(TX)	T	12.2/124.1
D2203	1790001770	S.DIO MA80WK-(TX)	T	35.9/103.5
D2204	1790001770	S.DIO MA80WK-(TX)	T	13.5/103.6
D2301	1750000431	S.DIO HSB88WSTR-E	T	24.5/94.6
D3001	1790001670	S.DIO RB706F-40T106	T	105.6/83
D3002	1790001670	S.DIO RB706F-40T106	T	44.9/28.9
D3003	1790001670	S.DIO RB706F-40T106	T	44.9/32.7
D3004	1790001251	S.DIO MA2S1110GL	T	146.4/45.4
D3006	1790001670	S.DIO RB706F-40T106	T	113.9/101.9
D3007	1790001670	S.DIO RB706F-40T106	T	107.7/87.1
D3301	1790001251	S.DIO MA2S1110GL	T	110.9/48.6
D3302	1790001251	S.DIO MA2S1110GL	T	113.7/49.4
D3336	1790001251	S.DIO MA2S1110GL	T	107.3/45.9
D3337	1790001251	S.DIO MA2S1110GL	T	107.3/47.3
D3801	1790001251	S.DIO MA2S1110GL	T	153.5/31.6
D3802	1790001251	S.DIO MA2S1110GL	T	154.8/31.6
D3803	1790001251	S.DIO MA2S1110GL	T	156.1/31.6
D9001	1790001251	S.DIO MA2S1110GL	T	146.2/17
D9002	1790001251	S.DIO MA2S1110GL	T	128.1/151
D9003	1790001251	S.DIO MA2S1110GL	T	120/107
D9051	1790001251	S.DIO MA2S1110GL	T	183.7/24.8
D9052	1790001251	S.DIO MA2S1110GL	T	203.1/24.5
D9101	1790001251	S.DIO MA2S1110GL	T	30.2/24.7
D9102	1790001251	S.DIO MA2S1110GL	T	55.3/12.6
D9103	1790001670	S.DIO RB706F-40T106	T	249.6/15.7
D9104	1790001670	S.DIO RB706F-40T106	T	218.8/12.8
D9105	1790001670	S.DIO RB706F-40T106	T	224.3/12.8
FI201	2010002600	XTA 64M15A 64.455 MHz(FL-345)		
FI231	2010001880	MON HC-49/U 10.700 MHz(FL-231)		
FI301	2010002470	XTA 64M15B1 64.45500 MHz(FL-315)		
FI401	2020001960	CER CFWLB455KHFA-B0 (CFWWM455H)		
FI402	2020001330	CER CFWLA455KHFA-B0 (CFWS455HT)		
X3301	6050010501	S.XTA CR-636A SMD-49 14.7456 MHz	T	103.6/57.3
L1	6200002651	S.COI NLV25T-R18J	T	202.4/130.4
L2	6200010740	S.COI C2520C-R27G-A	T	197.9/130.5
L3	6200002861	S.COI NLV25T-4R7J	T	194.6/133.4
L51	6200002861	S.COI NLV25T-4R7J	T	176.2/134
L52	6200009881	S.COI NLV25T-820J	T	175.3/127.6
L53	6200004671	S.COI NLV25T-3R9J	T	179.6/133.4
L54	6200002041	S.COI NLV25T-101J	T	171.8/127.6
L55	6200002041	S.COI NLV25T-101J	T	182.9/131
L56	6200002041	S.COI NLV25T-101J	T	188.2/128.6
L101	6200003941	S.COI NLV25T-5R6J	T	160.3/118.5
L102	6200002861	S.COI NLV25T-4R7J	T	168.2/119.7
L103	6200002041	S.COI NLV25T-101J	T	167.6/122.5
L104	6200003281	S.COI NLV25T-2R2J	T	174.7/119.6
L105	6200002041	S.COI NLV25T-101J	T	174.1/122.5
L106	6200009861	S.COI NLV25T-1R5J	T	181.9/119.7
L107	6200002041	S.COI NLV25T-101J	T	181.1/122.5
L108	6200001981	S.COI NLV25T-1R0J	T	188.6/119.4
L109	6200002041	S.COI NLV25T-101J	T	188/122.4
L110	6200002851	S.COI NLV25T-R82J	T	195.4/119.6
L111	6200002041	S.COI NLV25T-101J	T	194.8/122.5
L112	6200003661	S.COI NLV25T-R68J	T	202.1/119.6
L113	6200002041	S.COI NLV25T-101J	T	201.6/123.3
L114	6200010960	S.COI C2520C-R47G-A (0.47U)	T	209.4/120.6

M.=Mounted side (T: Mounted on the Top side, B: Mounted on the Bottom side)  
S.=Surface mount</

[MAIN UNIT]

REF NO.	PARTS NO.	DESCRIPTION	M.	H/V LOCATION
L115	6200002041	S.COI NLV25T-101J	T	208.6/123.7
L116	6200010870	S.COI C2520C-R33G-A (0.33U)	T	216.2/121
L117	6200002041	S.COI NLV25T-101J	T	214.1/124.3
L118	6200002861	S.COI NLV25T-4R7J	T	161.2/115.6
L119	6200002001	S.COI NLV25T-3R3J	T	167.7/116.9
L120	6200003281	S.COI NLV25T-2R2J	T	174.1/116.7
L121	6200009861	S.COI NLV25T-1R5J	T	181.3/116.8
L122	6200001981	S.COI NLV25T-1R0J	T	188/116.4
L123	6200003661	S.COI NLV25T-R68J	T	194.9/116.6
L124	6200002611	S.COI NLV25T-R47J	T	201.5/116.6
L125	6200011450	S.COI C2520C-R39G-A	T	208.6/117.1
L126	6200010740	S.COI C2520C-R27G-A	T	215.6/117.3
L127	6200002001	S.COI NLV25T-3R3J	T	165.8/113.8
L128	6200003281	S.COI NLV25T-2R2J	T	173.6/112.5
L129	6200003661	S.COI NLV25T-R68J	T	195.4/113.7
L130	6200002611	S.COI NLV25T-R47J	T	202.1/113.6
L131	6200011450	S.COI C2520C-R39G-A	T	208.4/113.5
L132	6200010740	S.COI C2520C-R27G-A	T	216.2/113.6
L133	6200003941	S.COI NLV25T-5R6J	T	166.1/111.1
L134	6200004951	S.COI NLV25T-1R8J	T	180.4/112.6
L135	6200001981	S.COI NLV25T-1R0J	T	188.6/113.4
L136	6200003661	S.COI NLV25T-R68J	T	194.2/110.8
L137	6200003271	S.COI NLV25T-R56J	T	200.3/110.3
L138	6200011450	S.COI C2520C-R39G-A	T	208/109.6
L139	6200010870	S.COI C2520C-R33G-A (0.33U)	T	214.5/109.9
L140	6200002041	S.COI NLV25T-101J	T	160.8/121.5
L141	6200004951	S.COI NLV25T-1R8J	T	174.3/109.5
L142	6200004741	S.COI NLV25T-1R2J	T	181.3/109.8
L143	6200002851	S.COI NLV25T-R82J	T	186.8/110
L144	6200002041	S.COI NLV25T-101J	T	161.9/107.8
L201	6200002041	S.COI NLV25T-101J	T	199.1/104.4
L202	6200010740	S.COI C2520C-R27G-A	T	190.9/100.2
L203	6200010740	S.COI C2520C-R27G-A	T	185.8/102.3
L204	6140003620	COI LR-403		
L205	6200002041	S.COI NLV25T-101J	T	216/55.9
L206	6200002631	S.COI NLV25T-R10J	T	183.3/83
L207	6150004270	COI LS-483A (C-14924)		
L208	6150005110	COI LS-540		
L209	6150005110	COI LS-540		
L210	6150004270	COI LS-483A (C-14924)		
L301	6150005110	COI LS-540		
L302	6150005110	COI LS-540		
L303	6140002810	S.COI LR-317	T	160/45.6
L304	6140003530	COI LR-395		
L305	6200005011	S.COI NLV25T-100J	T	161.5/68.1
L306	6200009871	S.COI NLV25T-120J	T	157.3/69.1
L307	6150005110	COI LS-540		
L401	6150005140	COI LS-542		
L402	6150005140	COI LS-542		
L403	6150002291	COI LS-450		
L404	6150005140	COI LS-542		
L405	6150005140	COI LS-542		
L406	6200003520	S.COI ELJFB 102K-F	T	128/92.3
L502	6200003520	S.COI ELJFB 102K-F	T	87.5/93.9
L504	6200002041	S.COI NLV25T-101J	T	94.1/88.9
L505	6200002041	S.COI NLV25T-101J	T	91.2/86
L506	6200003520	S.COI ELJFB 102K-F	T	87.7/88.4
L601	6200005011	S.COI NLV25T-100J	T	195.5/85.1
L602	6200002841	S.COI NLV25T-R22J	T	204.3/85.9
L603	6200003281	S.COI NLV25T-2R2J	T	196.9/77.8
L604	6200010870	S.COI C2520C-R33G-A (0.33U)	T	200/71.8
L605	6200002841	S.COI NLV25T-R22J	T	196.6/69.7
L701	6140002810	S.COI LR-317	T	198/100.6
L702	6200001981	S.COI NLV25T-1R0J	T	210.7/101.7
L703	6200003661	S.COI NLV25T-R68J	T	213.5/100.6
L704	6200002041	S.COI NLV25T-101J	T	212.5/84
L705	6200002041	S.COI NLV25T-101J	T	208.5/82.9
L706	6150004270	COI LS-483A (C-14924)		
L707	6140002810	S.COI LR-317	T	202.9/66
L801	6150004440	COI LS-495		
L901	6200002041	S.COI NLV25T-101J	T	85.1/83
L902	6200002041	S.COI NLV25T-101J	T	82.3/81.8
L903	6200002041	S.COI NLV25T-101J	T	82.4/85.7
L904	6200011520	S.COI SLF7045T-102MR14-PF	T	119.4/105.2
L1301	6200005491	S.COI NLV32T-331J	T	87.7/109.4
L1302	6200005491	S.COI NLV32T-331J	T	83.2/105.8
L1551	6180001000	COI LAL 02NA 102K		
L1552	6180001000	COI LAL 04NA 102K		
L1601	6180003640	COI SZW1012T-142-0.3		
L1602	6200002041	S.COI NLV25T-101J	T	22.7/54.6
L1901	6200002041	S.COI NLV25T-101J	T	122.6/128.7
L1902	6200002041	S.COI NLV25T-101J	T	128.6/129.1
L1903	6200002041	S.COI NLV25T-101J	T	143.5/128.1
L1904	6200003950	S.COI HF50ACC 322513-T	T	129.1/126.3
L1905	6200002041	S.COI NLV25T-101J	T	140.8/128.1
L1906	6140002220	COI LR-270 (TR6X3X2 3A9)		
L1907	6200003950	S.COI HF50ACC 322513-T	T	18.4/31.5
L1908	6200003950	S.COI HF50ACC 322513-T	T	125.4/128
L2051	6200002041	S.COI NLV25T-101J	T	48.7/19.2
L2052	6200002041	S.COI NLV25T-101J	T	60.9/29
L2053	6200002041	S.COI NLV25T-101J	T	63.4/29
L2054	6200002041	S.COI NLV25T-101J	T	58.4/29
L2055	6200011520	S.COI SLF7045T-102MR14-PF	T	51.5/33.1
L2056	6200003241	S.COI NLV32T-221J	T	51.8/26.7
L2057	6200003241	S.COI NLV32T-221J	T	48.8/26.7
L2058	6200011520	S.COI SLF7045T-102MR14-PF	T	59.4/34.5
L2101	6200002041	S.COI NLV25T-101J	T	35.4/124.9
L2201	6200003281	S.COI NLV25T-2R2J	T	36.2/121.9
L2202	6200002041	S.COI NLV25T-101J	T	39.2/122.9
L2204	6200002041	S.COI NLV25T-101J	T	28.7/122.6
L2205	6180001730	COI LAL 02NA 1R8K		
L2206	6200002041	S.COI NLV25T-101J	T	8.4/122.9
L2207	6200003711	S.COI NLV25T-2R7J	T	42.3/121
L2208	6200002611	S.COI NLV25T-R47J	T	28.3/119.8

[MAIN UNIT]

REF NO.	PARTS NO.	DESCRIPTION	M.	H/V LOCATION
L2209	6200007790	S.COI LQW2BHN15J03L	T	6.9/119.4
L2210	6200004951	S.COI NLV25T-1R8J	T	36.2/118.3
L2211	6180002380	COI LAL 02NA 2R2K		
L2212	6180001730	COI LAL 02NA 1R8K		
L2213	6200005031	S.COI NLV25T-180J	T	39.1/118
L2214	6200002001	S.COI NLV25T-3R3J	T	27.5/116.9
L2215	6200002851	S.COI NLV25T-R82J	T	6.4/115.1
L2216	6200003281	S.COI NLV25T-2R2J	T	38.5/115
L2217	6200003281	S.COI NLV25T-2R2J	T	27.5/113.9
L2218	6180002300	COI LAL 02NA 1R2K		
L2219	6200005041	S.COI NLV25T-220J	T	36.2/111.9
L2220	6200003711	S.COI NLV25T-2R7J	T	42.2/114.9
L2221	6180001210	COI LAL 03NA 8R2K		
L2222	6200010870	S.COI C2520C-R33G-A (0.33U)	T	32/114.2
L2223	6200004741	S.COI NLV25T-1R2J	T	3.9/109.2
L2224	6200007780	S.COI LQW2BHN12J03L	T	10.4/113.6
L2225	6200004741	S.COI NLV25T-1R2J	T	37.1/108.8
L2226	6200001981	S.COI NLV25T-1R0J	T	25.5/107.3
L2227	6200002611	S.COI NLV25T-R47J	T	4.5/105
L2228	6200002001	S.COI NLV25T-3R3J	T	42.4/110.7
L2229	6200002611	S.COI NLV25T-R47J	T	31.7/110.8
L2230	6200007780	S.COI LQW2BHN12J03L	T	9.9/108.7
L2231	6200002041	S.COI NLV25T-101J	T	43/106.8
L2232	6200002041	S.COI NLV25T-101J	T	29.7/105.4
L2233	6200002041	S.COI NLV25T-101J	T	9.1/103.9
L2235	6180000680	COI LAL 02NA 4R7K		
L2236	6200002041	S.COI NLV25T-101J	T	18/123.3
L2237	6200007760	S.COI LQW2BHN82NJ03L	T	17.7/119.9
L2238	6180002920	COI LAL 02NA 5R6K		
L2239	6200003661	S.COI NLV25T-R68J	T	17.2/117
L2240	6200003941	S.COI NLV25T-5R6J	T	17.1/113.9
L2241	6200001981	S.COI NLV25T-1R0J	T	14.7/110.9
L2242	6200007760	S.COI LQW2BHN82NJ03L	T	20/114
L2243	6200003271	S.COI NLV25T-R56J	T	16.3/107.8
L2244	6200007760	S.COI LQW2BHN82NJ03L	T	21.4/109.6
L2245	6200002041	S.COI NLV25T-101J	T	19/104.6
L2301	6200002041	S.COI NLV25T-101J	T	39.2/102.5
L2302	6140003660	COI LR-409		
L2304	6140003660	COI LR-409		
L2305	6200010740	S.COI C2520C-R27G-A	T	11.1/98.9
L2306	6150005150	COI LS-543		
L2307	6150005380	COI LS-552		
L2401	6200010221	S.COI NLV25T-560J	T	38.2/83.2
L2501	6200010221	S.COI NLV25T-560J	T	44.4/69.2
L2701	6200003520	S.COI ELJFB 102K-F	T	33.9/60.8
L2702	6200003520	S.COI ELJFB 102K-F	T	35.7/57.1
L2703	6200002041	S.COI NLV25T-101J	T	31.9/63.9
L3301	6200001831	S.COI NLV32T-100J	T	128.6/24.8
L3601	6200003950	S.COI HF50ACC 322513-T	T	66.2/32.1
L3602	6200003950	S.COI HF50ACC 322513-T	T	69.8/34
L9001	6200002041	S.COI NLV25T-101J	T	150.9/23.2
L9002	6200003950	S.COI HF50ACC 322513-T	T	155.9/23.8
L9151	6200005011	S.COI NLV25T-100J	T	233.2/19.1
L9152	6200005011	S.COI NLV25T-100J	T	252.7/18
L9153	6200002041	S.COI NLV25T-101J	T	165.8/19.6
L9154	6200005011	S.COI NLV25T-100J	T	211.2/11.8
R1	7030003240	S.RES ERJ3GEYJ 220 V (22)	T	209.1/128.8
R2	7030003340	S.RES ERJ3GEYJ 151 V (150)	T	209.1/130.1
R3	7030003340	S.RES ERJ3GEYJ 151 V (150)	T	206.4/130.1
R4	7030003280	S.RES ERJ3GEYJ 470 V (47)	T	194.4/131.1
R5	7030003230	S.RES ERJ3GEYJ 180 V (18)	T	188.5/132
R6	7030003370	S.RES ERJ3GEYJ 271 V (270)	T	189.3/133.8
R7	7030003370	S.RES ERJ3GEYJ 271 V (270)	T	187.9/133.8
R8	7030003400	S.RES ERJ3GEYJ 471 V (470)	T	185.3/133.8
R9	7030003230	S.RES ERJ3GEYJ 180 V (18)	T	206.4/128.8
R10	7030003240	S.RES ERJ3GEYJ 220 V (22)	T	194.4/129.8
R54	7030003410	S.RES ERJ3GEYJ 561 V (560)	T	179.7/129.5
R56	7030003360	S.RES ERJ3GEYJ 221 V (220)	T	179.7/128
R57	7030003400	S.RES ERJ3GEYJ 471 V (470)	T	183.3/129.1
R58	7030003400	S.RES ERJ3GEYJ 471 V (470)	T	185.3/128.6
R59	7030003440	S.RES ERJ3GEYJ 102 V (1K)	T	166.5/125.9
R60	7030003440	S.RES ERJ3GEYJ 102 V (1K)	T	163.9/125.1
R61	7030003560	S.RES ERJ3GEYJ 103 V (10K)	T	165.8/127.9
R101	7030003360	S.RES ERJ3GEYJ 221 V (220)	T	163.8/111.2
R102	7030003360	S.RES ERJ3GEYJ 221 V (220)	T	173.8/107.6
R103	7030003360	S.RES ERJ3GEYJ 221 V (220)	T	180.6/107.9
R104	7030003360	S.RES ERJ3GEYJ 221 V (220)	T	186.1/108.1
R105	7030003360	S.RES ERJ3GEYJ 221 V (220)	T	194.4/108.9
R106	7030003360	S.RES ERJ3GEYJ 221 V (220)	T	200.1/108.4
R107	7030003360	S.RES ERJ3GEYJ 221 V (220)	T	205.3/111.1
R108	7030003360	S.RES ERJ3GEYJ 221 V (220)	T	213.7/107.6
R109	7030003360	S.RES ERJ3GEYJ 221 V (220)	T	160.5/112.5
R110	7030003400	S.RES ERJ3GEYJ 471 V (470)	T	164.6/106.8
R201	7030003400	S.RES ERJ3GEYJ 471 V (470)	T	195.6/104.2
R202	7030003360	S.RES ERJ3GEYJ 221 V (220)	T	179/96.5
R203	7030003240	S.RES ERJ3GEYJ		

[MAIN UNIT]

REF NO.	PARTS NO.	DESCRIPTION	M.	H/V LOCATION
R309	7030003440	S.RES ERJ3GEYJ 102 V (1K)	T	208.3/57.1
R401	7030003440	S.RES ERJ3GEYJ 102 V (1K)	T	167.6/74.6
R404	7030003640	S.RES ERJ3GEYJ 473 V (47K)	T	140.3/102.1
R405	7030003560	S.RES ERJ3GEYJ 103 V (10K)	T	139.5/100.6
R406	7030003760	S.RES ERJ3GEYJ 474 V (470K)	T	136.6/106
R407	7030003320	S.RES ERJ3GEYJ 101 V (100)	T	136/98.6
R408	7030003400	S.RES ERJ3GEYJ 471 V (470)	T	134.2/104
R409	7030003320	S.RES ERJ3GEYJ 101 V (100)	T	140/105.3
R410	7030003440	S.RES ERJ3GEYJ 102 V (1K)	T	118.8/100.3
R413	7030003440	S.RES ERJ3GEYJ 102 V (1K)	T	104.9/101.1
R414	7030003440	S.RES ERJ3GEYJ 102 V (1K)	T	128.9/97.1
R415	7030003480	S.RES ERJ3GEYJ 222 V (2.2K)	T	89.1/107.2
R501	7030003860	S.RES ERJ3GE JPW V	T	85.6/102.4
R502	7030005871	S.RES ERA3YKD 104V (100K)	T	89/96.4
R503	7030003610	S.RES ERJ3GEYJ 273 V (27K)	T	88.9/97.7
R504	7030003440	S.RES ERJ3GEYJ 102 V (1K)	T	89/99
R505	7030003430	S.RES ERJ3GEYJ 821 V (820)	T	95.2/94.1
R506	7030003400	S.RES ERJ3GEYJ 471 V (470)	T	91.2/93.3
R507	7030003320	S.RES ERJ3GEYJ 101 V (100)	T	85.6/97
R508	7510001451	S.THE NTCG16 4BH 472JT	T	95.2/95.4
R509	7030003600	S.RES ERJ3GEYJ 223 V (22K)	T	86.9/97
R514	7030003440	S.RES ERJ3GEYJ 102 V (1K)	T	91.2/87.9
R601	7030006220	S.RES ERJ12YJ470U (47)	T	194.5/81.5
R602	7030003280	S.RES ERJ3GEYJ 470 V (47)	T	202.2/83.8
R603	7030009591	S.RES ERA3YED 472V (4.7K)	T	199.4/81.3
R604	7030003440	S.RES ERJ3GEYJ 102 V (1K)	T	202/81.3
R605	7030003200	S.RES ERJ3GEYJ 100 V (10)	T	198.2/75.3
R606	7030003440	S.RES ERJ3GEYJ 102 V (1K)	T	194.1/74.4
R607	7030003440	S.RES ERJ3GEYJ 102 V (1K)	T	191.2/73.1
R608	7030003400	S.RES ERJ3GEYJ 471 V (470)	T	203.3/81.7
R609	7030003440	S.RES ERJ3GEYJ 102 V (1K)	T	198.1/81.3
R610	7030003200	S.RES ERJ3GEYJ 100 V (10)	T	201.4/85.7
R701	7030003360	S.RES ERJ3GEYJ 221 V (220)	T	202.2/100.6
R702	7030003410	S.RES ERJ3GEYJ 561 V (560)	T	202.3/97.2
R703	7030003440	S.RES ERJ3GEYJ 102 V (1K)	T	207/103.4
R704	7030003640	S.RES ERJ3GEYJ 473 V (47K)	T	204.9/102.8
R705	7030003360	S.RES ERJ3GEYJ 221 V (220)	T	205.7/97.5
R706	7030003320	S.RES ERJ3GEYJ 101 V (100)	T	207.7/100.7
R707	7510001461	S.THE NTCG16 3NH 471JT	T	207.7/99.4
R708	7030003440	S.RES ERJ3GEYJ 102 V (1K)	T	215.2/77.2
R709	7030003440	S.RES ERJ3GEYJ 102 V (1K)	T	210.4/77.2
R710	7030003360	S.RES ERJ3GEYJ 221 V (220)	T	211.4/81.3
R711	7030003400	S.RES ERJ3GEYJ 471 V (470)	T	210.2/75
R712	7030003370	S.RES ERJ3GEYJ 271 V (270)	T	210/64.4
R713	7030003230	S.RES ERJ3GEYJ 180 V (18)	T	194.2/64
R714	7030003370	S.RES ERJ3GEYJ 271 V (270)	T	192.2/63.2
R715	7030003230	S.RES ERJ3GEYJ 180 V (18)	T	210/63.1
R716	7030003370	S.RES ERJ3GEYJ 271 V (270)	T	207.6/63.6
R717	7030003370	S.RES ERJ3GEYJ 271 V (270)	T	192.2/64.8
R718	7030003440	S.RES ERJ3GEYJ 102 V (1K)	T	193.2/70.3
R719	7030003320	S.RES ERJ3GEYJ 101 V (100)	T	198.7/97.3
R720	7030003550	S.RES ERJ3GEYJ 822 V (8.2K)	T	199/65.1
R722	7510001461	S.THE NTCG16 3NH 471JT	T	203.6/97.4
R801	7030003480	S.RES ERJ3GEYJ 222 V (2.2K)	T	136.3/93
R802	7030003240	S.RES ERJ3GEYJ 220 V (22)	T	131.5/97.1
R803	7030003860	S.RES ERJ3GE JPW V	T	133.8/95.1
R804	7030003400	S.RES ERJ3GEYJ 471 V (470)	T	130.6/90.3
R813	7030003600	S.RES ERJ3GEYJ 223 V (22K)	T	131.2/95.1
R901	7030003440	S.RES ERJ3GEYJ 102 V (1K)	T	80.3/73.7
R902	7030003440	S.RES ERJ3GEYJ 102 V (1K)	T	82.5/78.4
R903	7030003440	S.RES ERJ3GEYJ 102 V (1K)	T	85.5/74.1
R904	7030003280	S.RES ERJ3GEYJ 470 V (47)	T	82.4/83.8
R910	7030003440	S.RES ERJ3GEYJ 102 V (1K)	T	82.8/79.9
R911	7030003440	S.RES ERJ3GEYJ 102 V (1K)	T	84.1/89.4
R1002	7030003400	S.RES ERJ3GEYJ 471 V (470)	T	74.4/58.3
R1003	7030003400	S.RES ERJ3GEYJ 471 V (470)	T	79.5/63.8
R1004	7030003440	S.RES ERJ3GEYJ 102 V (1K)	T	75.7/52.6
R1005	7030003440	S.RES ERJ3GEYJ 102 V (1K)	T	80.1/52.7
R1006	7030003440	S.RES ERJ3GEYJ 102 V (1K)	T	81/62.1
R1007	7030003440	S.RES ERJ3GEYJ 102 V (1K)	T	82.3/62.1
R1008	7030003320	S.RES ERJ3GEYJ 101 V (100)	T	85.8/61.9
R1009	7030003320	S.RES ERJ3GEYJ 101 V (100)	T	87.2/67.6
R1010	7030003440	S.RES ERJ3GEYJ 102 V (1K)	T	85.5/65
R1011	7030003440	S.RES ERJ3GEYJ 102 V (1K)	T	91.9/66.7
R1012	7030003860	S.RES ERJ3GE JPW V	T	93.9/66
R1014	7030003440	S.RES ERJ3GEYJ 102 V (1K)	T	92.6/68.6
R1015	7030003650	S.RES ERJ3GEYJ 563 V (56K)	T	89.2/66.7
R1016	7030003560	S.RES ERJ3GEYJ 103 V (10K)	T	91.1/68.6
R1017	7030003440	S.RES ERJ3GEYJ 102 V (1K)	T	81.7/56
R1018	7030003320	S.RES ERJ3GEYJ 101 V (100)	T	72.2/51.4
R1051	7030003320	S.RES ERJ3GEYJ 101 V (100)	T	70.8/51.4
R1052	7030003320	S.RES ERJ3GEYJ 101 V (100)	T	78.4/43.9
R1053	7030003440	S.RES ERJ3GEYJ 102 V (1K)	T	76.1/50
R1054	7030003440	S.RES ERJ3GEYJ 102 V (1K)	T	79.4/50.8
R1055	7030003440	S.RES ERJ3GEYJ 102 V (1K)	T	77.6/46.2
R1057	7030003440	S.RES ERJ3GEYJ 102 V (1K)	T	69.4/44.1
R1058	7030003440	S.RES ERJ3GEYJ 102 V (1K)	T	70.7/41.4
R1059	7030003440	S.RES ERJ3GEYJ 102 V (1K)	T	74.7/40
R1060	7030005871	S.RES ERA3YKD 104V (100K)	T	70.7/46.7
R1101	7030005871	S.RES ERA3YKD 104V (100K)	T	50.2/84.6
R1102	7030009591	S.RES ERA3YED 472V (4.7K)	T	50.7/80
R1103	7030005871	S.RES ERA3YKD 104V (100K)	T	50.2/85.9
R1104	7030003800	S.RES ERJ3GEYJ 105 V (1M)	T	48.8/89.9
R1105	7030003500	S.RES ERJ3GEYJ 332 V (3.3K)	T	45.5/80
R1106	7030003720	S.RES ERJ3GEYJ 224 V (220K)	T	50.2/88.6
R1107	7030003800	S.RES ERJ3GEYJ 105 V (1M)	T	44/80
R1108	7030003800	S.RES ERJ3GEYJ 105 V (1M)	T	46.2/89.6
R1109	7030003320	S.RES ERJ3GEYJ 101 V (100)	T	43.5/89.9
R1110	7030003320	S.RES ERJ3GEYJ 101 V (100)	T	50.2/82
R1111	7030003560	S.RES ERJ3GEYJ 103 V (10K)	T	50.2/83.3
R1112	7030003560	S.RES ERJ3GEYJ 103 V (10K)	T	50.2/87.2
R1113	7030003320	S.RES ERJ3GEYJ 101 V (100)	T	42.6/81.9
R1114	7030003320	S.RES ERJ3GEYJ 101 V (100)	T	42.6/84.6
R1115	7030003860	S.RES ERJ3GE JPW V	T	153.5/52.2

[MAIN UNIT]

REF NO.	PARTS NO.	DESCRIPTION	M.	H/V LOCATION
R1116	7030003860	S.RES ERJ3GE JPW V	T	153.5/53.5
R1118	7030003640	S.RES ERJ3GEYJ 473 V (47K)	T	51.5/89.9
R1201	7030003760	S.RES ERJ3GEYJ 474 V (470K)	T	109.9/110.8
R1202	7030003760	S.RES ERJ3GEYJ 474 V (470K)	T	110.5/120.2
R1203	7030003760	S.RES ERJ3GEYJ 474 V (470K)	T	112.7/114.5
R1204	7030003760	S.RES ERJ3GEYJ 474 V (470K)	T	112.7/113.2
R1205	7030005871	S.RES ERA3YKD 104V (100K)	T	114.8/110.4
R1206	7030003760	S.RES ERJ3GEYJ 474 V (470K)	T	115.4/112.2
R1207	7030003560	S.RES ERJ3GEYJ 103 V (10K)	T	128.1/118.1
R1208	7030003560	S.RES ERJ3GEYJ 103 V (10K)	T	123.6/116.5
R1209	7030003640	S.RES ERJ3GEYJ 473 V (47K)	T	123.7/122.2
R1210	7030003640	S.RES ERJ3GEYJ 473 V (47K)	T	109/119.2
R1211	7030005871	S.RES ERA3YKD 104V (100K)	T	124.4/113.9
R1212	7030005871	S.RES ERA3YKD 104V (100K)	T	127.4/116.8
R1213	7030005871	S.RES ERA3YKD 104V (100K)	T	112.7/117.1
R1214	7030003760	S.RES ERJ3GEYJ 474 V (470K)	T	112.7/115.8
R1215	7030003640	S.RES ERJ3GEYJ 473 V (47K)	T	123.4/117.8
R1216	7030003640	S.RES ERJ3GEYJ 473 V (47K)	T	120.9/120.4
R1217	7030003720	S.RES ERJ3GEYJ 224 V (220K)	T	118.4/111.7
R1218	7030003640	S.RES ERJ3GEYJ 473 V (47K)	T	117.3/119.6
R1219	7030003720	S.RES ERJ3GEYJ 224 V (220K)	T	122.6/113.3
R1220	7030003840	S.RES ERJ3GEYJ 225 V (2.2M)	T	120.9/119.1
R1221	7030003840	S.RES ERJ3GEYJ 225 V (2.2M)	T	115.3/119.1
R1222	7030003370	S.RES ERJ3GEYJ 271 V (270)	T	123.7/111.5
R1223	7030003480	S.RES ERJ3GEYJ 222 V (2.2K)	T	137/111.9
R1224	7030003320	S.RES ERJ3GEYJ 101 V (100)	T	118.6/119.6
R1225	7030003320	S.RES ERJ3GEYJ 101 V (100)	T	117.1/110.4
R1226	7030003360	S.RES ERJ3GEYJ 221 V (220)	T	131.9/117.4
R1227	7030003860	S.RES ERJ3GE JPW V	T	133.9/117
R1228	7030003440	S.RES ERJ3GEYJ 102 V (1K)	T	136.1/121.6
R1230	7030003760	S.RES ERJ3GEYJ 474 V (470K)	T	136.3/90.4
R1231	7030003860	S.RES ERJ3GE JPW V	T	115.7/121.9
R1232	7030009930	S.RES ERJ3GEYJ 825 V (8.2M)	T	125.2/118.9
R1233	7030003760	S.RES ERJ3GEYJ 474 V (470K)	T	112.5/111.9
R1234	7030003560	S.RES ERJ3GEYJ 103 V (10K)	T	140.9/122.3
R1235	7030003560	S.RES ERJ3GEYJ 103 V (10K)	T	142.7/121.5
R1240	7030003440	S.RES ERJ3GEYJ 102 V (1K)	T	112.5/119.7
R1241	7030003720	S.RES ERJ3GEYJ 224 V (220K)	T	123.3/115.2
R1242	7030005871	S.RES ERA3YKD 104V (100K)	T	109.9/117.2
R1301	7030003200	S.RES ERJ3GEYJ 100 V (10)	T	94.3/125.4
R1302	7030003200	S.RES ERJ3GEYJ 100 V (10)	T	95.6/125.4
R1303	7030003200	S.RES ERJ3GEYJ 100 V (10)	T	96.9/125.4
R1304	7030003200	S.RES ERJ3GEYJ 100 V (10)	T	98.2/125.4
R1305	7030003200	S.RES ERJ3GEYJ 100 V (10)	T	99.5/125.4
R1306	7030003200	S.RES ERJ3GEYJ 100 V (10)	T	100.8/125.4
R1307	7030003200	S.RES ERJ3GEYJ 100 V (10)	T	102.1/125.4
R1308	7030003200	S.RES ERJ3GEYJ 100 V (10)	T	103.4/125.4
R1309	7030004040	S.RES ERJ3GEYJ 4R7 V (4.7)	T	91.5/116.2
R1310	7030003500	S.RES ERJ3GEYJ 332 V (3.3K)	T	161.6/103.7
R1311	7030003500	S.RES ERJ3GEYJ 332 V (3.3K)	T	162.9/103.7
R1312	7030003500	S.RES ERJ3GEYJ 332 V (3.3K)	T	164.2/103.7
R1313	7030003500	S.RES ERJ3GEYJ 332 V (3.3K)	T	165.5/103.7
R1314	7030003500	S.RES ERJ3GEYJ 332 V (3.3K)	T	166.8/103.7
R1315	7030003500	S.RES ERJ3GEYJ 332 V (3.3K)	T	168.1/103.7
R1316	7030003500	S.RES ERJ3GEYJ 332 V (3.3K)	T	169.4/103.7
R1317	7030003500	S.RES ERJ3GEYJ 332 V (3.3K)	T	170.7/103.7
R1318	7030004040	S.RES ERJ3GEYJ 4R7 V (4.7)	T	174.3/90.6
R1319	7030004040	S.RES ERJ3GEYJ 4R7 V (4.7)	T	53.8/98.9
R1320	7030003500	S.RES ERJ3GEYJ 332 V (3.3K)	T	50.7/111.5
R1501	7030010420	S.RES ERJ1TYJ 560U (56)	T	4/78.4
R1502	7030004040	S.RES ERJ3GEYJ 4R7 V (4.7)	T	89.5/118.1
R1503	7030004040	S.RES ERJ3GEYJ 4R7 V (4.7)	T	89.5/119.4
R1504	7030003440	S.RES ERJ3GEYJ 102 V (1K)	T	87.4/112.6
R1505	7030003440	S.RES ERJ3GEYJ 102 V (1K)	T	88.7/121.5
R1506	7030009620	S.RES ERJ12YJ120U (12)	T	146.2/109.5
R1507	7030009620	S.RES ERJ12YJ120U (12)	T	146.2/113.2
R1551	7030006220	S.RES ERJ12YJ470U (47)	T	75.1/128.9
R1553	7030006220	S.RES ERJ12YJ470U (47)	T	55.6/131.1
R1555	7030003560	S.RES ERJ3GEYJ 103 V (10K)	T	59.9/130.3
R1556	7030003720	S.RES ERJ3GEYJ 224 V (220K)	T	61.3/129.2
R1601	7030003400	S.RES ERJ3GEYJ 471 V (470)	T	14.9/32.4
R1602	7030003440	S.RES ERJ3GEYJ 102 V (1K)	T	17.3/2

[MAIN UNIT]

REF NO.	PARTS NO.	DESCRIPTION	M.	H/V LOCATION
R1715	7030003550	S.RES ERJ3GEYJ 822 V (8.2K)	T	44.5/42
R1716	7030003480	S.RES ERJ3GEYJ 222 V (2.2K)	T	44.5/40.7
R1717	7030003440	S.RES ERJ3GEYJ 102 V (1K)	T	46.5/41.3
R1718	7030003560	S.RES ERJ3GEYJ 103 V (10K)	T	44.5/39.4
R1719	7030003560	S.RES ERJ3GEYJ 103 V (10K)	T	79.3/66.6
R1720	7030003400	S.RES ERJ3GEYJ 471 V (470)	T	75.4/70.8
R1721	7030003400	S.RES ERJ3GEYJ 471 V (470)	T	75.3/62.1
R1722	7030003440	S.RES ERJ3GEYJ 102 V (1K)	T	75.3/63.4
R1723	7030003440	S.RES ERJ3GEYJ 102 V (1K)	T	74.5/65.4
R1724	7030003400	S.RES ERJ3GEYJ 471 V (470)	T	58.9/69.1
R1725	7030003400	S.RES ERJ3GEYJ 471 V (470)	T	60.4/71
R1726	7030009591	S.RES ERA3YED 472V (4.7K)	T	26.6/53.7
R1801	7030003500	S.RES ERJ3GEYJ 332 V (3.3K)	T	143.8/36.4
R1802	7030003500	S.RES ERJ3GEYJ 332 V (3.3K)	T	145.1/36.4
R1803	7030003500	S.RES ERJ3GEYJ 332 V (3.3K)	T	146.4/36.7
R1804	7030003560	S.RES ERJ3GEYJ 103 V (10K)	T	145.1/39.1
R1901	7030004040	S.RES ERJ3GEYJ 4R7 V (4.7)	T	135/128.5
R1902	7030003440	S.RES ERJ3GEYJ 102 V (1K)	T	138.4/126.6
R1903	7030003440	S.RES ERJ3GEYJ 102 V (1K)	T	121.1/132.9
R1904	7030003440	S.RES ERJ3GEYJ 102 V (1K)	T	132.9/129.3
R2001	7030003560	S.RES ERJ3GEYJ 103 V (10K)	T	63.2/45
R2002	7030003560	S.RES ERJ3GEYJ 103 V (10K)	T	63.8/52.7
R2004	7030003860	S.RES ERJ3GE JPW V	T	62.5/52.7
R2005	7030003860	S.RES ERJ3GE JPW V	T	64.4/43
R2101	7030003600	S.RES ERJ3GEYJ 223 V (22K)	T	37.1/127.3
R2102	7030003560	S.RES ERJ3GEYJ 103 V (10K)	T	42.7/127.5
R2103	7030003320	S.RES ERJ3GEYJ 101 V (100)	T	43.9/133.6
R2104	7030003560	S.RES ERJ3GEYJ 103 V (10K)	T	45.4/130.9
R2105	7030003400	S.RES ERJ3GEYJ 471 V (470)	T	38.4/124.9
R2106	7030003630	S.RES ERJ3GEYJ 393 V (39K)	T	20/126.5
R2107	7030003630	S.RES ERJ3GEYJ 393 V (39K)	T	17.4/126.5
R2108	7030003600	S.RES ERJ3GEYJ 223 V (22K)	T	45.4/133.6
R2201	7030003320	S.RES ERJ3GEYJ 101 V (100)	T	50.7/105
R2202	7030003320	S.RES ERJ3GEYJ 101 V (100)	T	50.7/103.7
R2203	7030003320	S.RES ERJ3GEYJ 101 V (100)	T	50.7/106.3
R2204	7030003320	S.RES ERJ3GEYJ 101 V (100)	T	50.7/107.6
R2205	7030003500	S.RES ERJ3GEYJ 332 V (3.3K)	T	42.9/103
R2206	7030003500	S.RES ERJ3GEYJ 332 V (3.3K)	T	48/103.1
R2207	7030003500	S.RES ERJ3GEYJ 332 V (3.3K)	T	46.9/108.1
R2208	7030003500	S.RES ERJ3GEYJ 332 V (3.3K)	T	46.9/106.7
R2301	7030003440	S.RES ERJ3GEYJ 102 V (1K)	T	39.5/104.5
R2302	7030003240	S.RES ERJ3GEYJ 220 V (22)	T	43.4/92.1
R2303	7030004040	S.RES ERJ3GEYJ 4R7 V (4.7)	T	32.5/100
R2306	7030003280	S.RES ERJ3GEYJ 470 V (47)	T	10.9/96.2
R2401	7030003650	S.RES ERJ3GEYJ 563 V (56K)	T	32/82.5
R2402	7030003580	S.RES ERJ3GEYJ 153 V (15K)	T	33.3/82.5
R2403	7030003800	S.RES ERJ3GEYJ 105 V (1M)	T	35.3/76.9
R2404	7030003320	S.RES ERJ3GEYJ 101 V (100)	T	35.4/83.2
R2405	7030003320	S.RES ERJ3GEYJ 101 V (100)	T	40.6/85.4
R2406	7030003480	S.RES ERJ3GEYJ 222 V (2.2K)	T	39.2/79.1
R2407	7030005691	S.RES ERA3YED 123V (12K)	T	32/82.5
R2501	7030009591	S.RES ERA3YED 472V (4.7K)	T	47.8/76.4
R2502	7030003440	S.RES ERJ3GEYJ 102 V (1K)	T	47.8/73.8
R2503	7030003760	S.RES ERJ3GEYJ 474 V (470K)	T	39.2/76.7
R2504	7030003320	S.RES ERJ3GEYJ 101 V (100)	T	48.4/70.4
R2505	7030003320	S.RES ERJ3GEYJ 101 V (100)	T	47.8/65.6
R2506	7030003400	S.RES ERJ3GEYJ 471 V (470)	T	45.1/65.6
R2507	7030003400	S.RES ERJ3GEYJ 471 V (470)	T	47.8/72.5
R2508	7030003480	S.RES ERJ3GEYJ 222 V (2.2K)	T	47.8/75.1
R2701	7030003440	S.RES ERJ3GEYJ 102 V (1K)	T	35/63.4
R2702	7030003650	S.RES ERJ3GEYJ 563 V (56K)	T	51.8/58.1
R2703	7030003560	S.RES ERJ3GEYJ 103 V (10K)	T	49.4/54.9
R2704	7030003650	S.RES ERJ3GEYJ 563 V (56K)	T	51.8/59.4
R2705	7030003650	S.RES ERJ3GEYJ 563 V (56K)	T	51.8/60.7
R2706	7030003370	S.RES ERJ3GEYJ 271 V (270)	T	45/55.9
R2708	7030003440	S.RES ERJ3GEYJ 102 V (1K)	T	53.6/62.2
R2709	7030003320	S.RES ERJ3GEYJ 101 V (100)	T	56.3/63.5
R2710	7030003320	S.RES ERJ3GEYJ 101 V (100)	T	53.5/54.6
R2711	7030003440	S.RES ERJ3GEYJ 102 V (1K)	T	56.3/62.2
R2712	7030003440	S.RES ERJ3GEYJ 102 V (1K)	T	61.2/56.2
R2713	7030003440	S.RES ERJ3GEYJ 102 V (1K)	T	64.2/61
R2714	7030003440	S.RES ERJ3GEYJ 102 V (1K)	T	62.5/61.6
R2715	7030003230	S.RES ERJ3GEYJ 180 V (18)	T	43.1/55.1
R2716	7030003370	S.RES ERJ3GEYJ 271 V (270)	T	43.1/56.4
R2717	7030003400	S.RES ERJ3GEYJ 471 V (470)	T	46.3/61.2
R2718	7030003400	S.RES ERJ3GEYJ 471 V (470)	T	45/61.2
R3001	7030003440	S.RES ERJ3GEYJ 102 V (1K)	T	117.4/87
R3002	7030003440	S.RES ERJ3GEYJ 102 V (1K)	T	113.5/87
R3003	7030003360	S.RES ERJ3GEYJ 221 V (220)	T	108.4/82.8
R3004	7030003360	S.RES ERJ3GEYJ 221 V (220)	T	110.1/82.8
R3005	7030003400	S.RES ERJ3GEYJ 471 V (470)	T	117.8/84.9
R3006	7030003440	S.RES ERJ3GEYJ 102 V (1K)	T	126.8/49.1
R3007	7030003440	S.RES ERJ3GEYJ 102 V (1K)	T	112.3/82.8
R3008	7030003440	S.RES ERJ3GEYJ 102 V (1K)	T	113.8/83.1
R3009	7030003440	S.RES ERJ3GEYJ 102 V (1K)	T	115.1/83
R3010	7030003440	S.RES ERJ3GEYJ 102 V (1K)	T	114/103.9
R3011	7030003440	S.RES ERJ3GEYJ 102 V (1K)	T	119.3/82.9
R3012	7030003440	S.RES ERJ3GEYJ 102 V (1K)	T	33.6/48.2
R3013	7030003560	S.RES ERJ3GEYJ 103 V (10K)	T	106.5/87
R3014	7030003800	S.RES ERJ3GEYJ 105 V (1M)	T	97.7/74.4
R3015	7030003560	S.RES ERJ3GEYJ 103 V (10K)	T	105.8/87
R3016	7030003400	S.RES ERJ3GEYJ 471 V (470)	T	113.1/85
R3017	7030003360	S.RES ERJ3GEYJ 221 V (220)	T	97.7/67.6
R3018	7030003640	S.RES ERJ3GEYJ 473 V (47K)	T	125.5/49.1
R3019	7030003440	S.RES ERJ3GEYJ 102 V (1K)	T	122.6/83
R3020	7030003640	S.RES ERJ3GEYJ 473 V (47K)	T	122.6/86.5
R3023	7030009591	S.RES ERA3YED 472V (4.7K)	T	47.1/29.7
R3024	7030003480	S.RES ERJ3GEYJ 222 V (2.2K)	T	47.1/32.5
R3025	7030003640	S.RES ERJ3GEYJ 473 V (47K)	T	45.2/27
R3026	7030003640	S.RES ERJ3GEYJ 473 V (47K)	T	45.2/30.8
R3027	7030009591	S.RES ERA3YED 472V (4.7K)	T	145.6/42.6
R3028	7030003640	S.RES ERJ3GEYJ 473 V (47K)	T	144.2/44.4
R3029	7030003580	S.RES ERJ3GEYJ 153 V (15K)	T	137.5/46.5
R3030	7030003600	S.RES ERJ3GEYJ 223 V (22K)	T	134.6/44.1

[MAIN UNIT]

REF NO.	PARTS NO.	DESCRIPTION	M.	H/V LOCATION
R3035	7030003600	S.RES ERJ3GEYJ 223 V (22K)	T	149.1/45.1
R3036	7030003640	S.RES ERJ3GEYJ 473 V (47K)	T	110.9/87
R3050	7030005691	S.RES ERA3YED 123V (12K)	T	115.4/89.2
R3051	7030009591	S.RES ERA3YED 472V (4.7K)	T	108.7/89.7
R3052	7030005871	S.RES ERA3YED 104V (100K)	T	110.7/89.7
R3101	7030010420	S.RES ERJ1TYJ 560U (56)	T	139.6/32.2
R3201	7030003640	S.RES ERJ3GEYJ 473 V (47K)	T	84.9/38
R3202	7030005871	S.RES ERA3YED 104V (100K)	T	91.6/42.1
R3203	7030003440	S.RES ERJ3GEYJ 102 V (1K)	T	89/42.1
R3204	7030003640	S.RES ERJ3GEYJ 473 V (47K)	T	93.2/43.9
R3301	7030003560	S.RES ERJ3GEYJ 103 V (10K)	T	118.8/77.1
R3302	7030003560	S.RES ERJ3GEYJ 103 V (10K)	T	119.8/78.4
R3303	7030003650	S.RES ERJ3GEYJ 563 V (56K)	T	101.6/68.2
R3304	7030003650	S.RES ERJ3GEYJ 563 V (56K)	T	101.6/65.5
R3305	7030003560	S.RES ERJ3GEYJ 103 V (10K)	T	107.2/68.1
R3306	7030003610	S.RES ERJ3GEYJ 273 V (27K)	T	121.3/83
R3307	7030003360	S.RES ERJ3GEYJ 221 V (220)	T	124.2/49.1
R3308	7030003360	S.RES ERJ3GEYJ 221 V (220)	T	97.7/79.6
R3309	7030003360	S.RES ERJ3GEYJ 221 V (220)	T	97.7/73.1
R3310	7030003360	S.RES ERJ3GEYJ 221 V (220)	T	97.7/71.8
R3311	7030003360	S.RES ERJ3GEYJ 221 V (220)	T	97.7/70.5
R3312	7030003440	S.RES ERJ3GEYJ 102 V (1K)	T	97.7/69.2
R3313	7030005871	S.RES ERA3YED 104V (100K)	T	121.5/49.1
R3314	7030005871	S.RES ERA3YED 104V (100K)	T	119.4/44.8
R3315	7030003560	S.RES ERJ3GEYJ 103 V (10K)	T	109.1/32.8
R3316	7030003720	S.RES ERJ3GEYJ 224 V (220K)	T	136.9/83
R3317	7030003720	S.RES ERJ3GEYJ 224 V (220K)	T	138.2/83
R3318	7030003720	S.RES ERJ3GEYJ 224 V (220K)	T	139.5/83
R3319	7030003720	S.RES ERJ3GEYJ 224 V (220K)	T	141.6/81.4
R3320	7030003720	S.RES ERJ3GEYJ 224 V (220K)	T	135.6/83
R3321	7030003720	S.RES ERJ3GEYJ 224 V (220K)	T	134.3/83
R3322	7030003720	S.RES ERJ3GEYJ 224 V (220K)	T	133/83
R3323	7030003720	S.RES ERJ3GEYJ 224 V (220K)	T	131.7/83
R3324	7030003720	S.RES ERJ3GEYJ 224 V (220K)	T	130.4/83
R3325	7030003720	S.RES ERJ3GEYJ 224 V (220K)	T	129.1/83
R3326	7030003720	S.RES ERJ3GEYJ 224 V (220K)	T	127.8/83
R3327	7030003720	S.RES ERJ3GEYJ 224 V (220K)	T	126.5/83
R3328	7030003720	S.RES ERJ3GEYJ 224 V (220K)	T	125.2/83
R3329	7030003720	S.RES ERJ3GEYJ 224 V (220K)	T	123.9/83
R3330	7030003720	S.RES ERJ3GEYJ 224 V (220K)	T	129.6/49.1
R3331	7030003720	S.RES ERJ3GEYJ 224 V (220K)	T	128.3/49.1
R3332	7030003640	S.RES ERJ3GEYJ 473 V (47K)	T	110.9/45.8
R3333	7030003360	S.RES ERJ3GEYJ 221 V (220)	T	109.5/47.5
R3334	7030003640	S.RES ERJ3GEYJ 473 V (47K)	T	114.9/46.3
R3335	7030003360	S.RES ERJ3GEYJ 221 V (220)	T	113/47.1
R3336	7030003360	S.RES ERJ3GEYJ 221 V (220)	T	115.8/49.1
R3337	7030003360	S.RES ERJ3GEYJ 221 V (220)	T	117.1/49.1
R3338	7030003360	S.RES ERJ3GEYJ 221 V (220)	T	142.5/75.2
R3339	7030003360	S.RES ERJ3GEYJ 221 V (220)	T	142.5/73.9
R3340	7030003360	S.RES ERJ3GEYJ 221 V (220)	T	122.9/49.1
R3350	7030003720	S.RES ERJ3GEYJ 224 V (220K)	T	120/87
R3402	7030003560	S.RES ERJ3GEYJ 103 V (10K)	T	138.2/86.5
R3403	7030003560	S.RES ERJ3GEYJ 103 V (10K)	T	139.5/86.5
R3405	7030003560	S.RES ERJ3GEYJ 103 V (10K)	T	135.6/86.5
R3406	7030003560	S.RES ERJ3GEYJ 103 V (10K)	T	134.3/86.5
R3408	7030003560	S.RES ERJ3GEYJ 103 V (10K)	T	131.7/86.5
R3411	7030003560	S.RES ERJ3GEYJ 103 V (10K)	T	127.8/86.5
R3412	7030003560	S.RES ERJ3GEYJ 103 V (10K)	T	126.5/86.5
R3601	7030003640	S.RES ERJ3GEYJ 473 V (47K)	T	71.3/23.7
R3602	7030003640	S.RES ERJ3GEYJ 473 V (47K)	T	76.4/23.7
R3603	7030003640	S.RES ERJ3GEYJ 473 V (47K)	T	81.8/23.7
R3604	7030003640	S.RES ERJ3GEYJ 473 V (47K)	T	77.7/23.7
R3605	7030003640	S.RES ERJ3GEYJ 473 V (47K)	T	72.8/23.7
R3606	7030003640	S.RES ERJ3GEYJ 473 V (47K)	T	74.1/23.7
R3608	7030003640	S.RES ERJ3GEYJ 473 V (47K)	T	86.2/57.1
R3609	7030003640	S.RES ERJ3GEYJ 473 V (47K)	T	87.3/53.8
R3610	7030003640	S.RES ERJ3GEYJ 473 V (47K)	T	86/53.8
R3611	7030003640	S.RES ERJ3GEYJ 473 V (47K)	T	84.7/53.8
R3612	7030003640	S.RES ERJ3GEYJ 473 V (47K)	T	83.4/53.8
R3613	7030003640	S.RES ERJ3GEYJ 473 V (47K)	T	142.5/57
R3614	7030003360	S.RES ERJ3GEYJ 221 V (220)	T	142.5/71.3
R3615	7030003360			

[MAIN UNIT]

REF NO.	PARTS NO.	DESCRIPTION	M.	H/V LOCATION
R9052	7030003280	S.RES ERJ3GEYJ 470 V (47)	T	182/15.3
R9057	7030003640	S.RES ERJ3GEYJ 473 V (47K)	T	161.9/9.2
R9059	7030009591	S.RES ERA3YED 472V (4.7K)	T	179.1/17.2
R9061	7030003640	S.RES ERJ3GEYJ 473 V (47K)	T	174.4/20.1
R9062	7030003640	S.RES ERJ3GEYJ 473 V (47K)	T	171.8/20.1
R9063	7030003640	S.RES ERJ3GEYJ 473 V (47K)	T	161.9/9.6
R9064	7030003640	S.RES ERJ3GEYJ 473 V (47K)	T	212.4/22.1
R9066	7030003860	S.RES ERJ3GE JPW V	T	184.7/12.6
R9067	7030003860	S.RES ERJ3GE JPW V	T	183.2/12.6
R9070	7030003860	S.RES ERJ3GE JPW V	T	180.8/12.7
R9071	7030003860	S.RES ERJ3GE JPW V	T	178.8/12.6
R9074	7030003640	S.RES ERJ3GEYJ 473 V (47K)	T	203.8/16.4
R9101	7030003440	S.RES ERJ3GEYJ 102 V (1K)	T	29.4/27.3
R9102	7030009591	S.RES ERA3YED 472V (4.7K)	T	47.8/16.4
R9103	7030003640	S.RES ERJ3GEYJ 473 V (47K)	T	54.6/14.8
R9104	7030003640	S.RES ERJ3GEYJ 473 V (47K)	T	57.9/12.6
R9106	7030003280	S.RES ERJ3GEYJ 470 V (47)	T	32.8/22.4
R9153	7030003440	S.RES ERJ3GEYJ 102 V (1K)	T	222.2/12.6
R9154	7030003440	S.RES ERJ3GEYJ 102 V (1K)	T	249.4/12.5
R9159	7030003440	S.RES ERJ3GEYJ 102 V (1K)	T	227.7/12.6
R9161	7030003640	S.RES ERJ3GEYJ 473 V (47K)	T	220.7/12.6
R9162	7030003640	S.RES ERJ3GEYJ 473 V (47K)	T	249.4/13.8
R9163	7030003640	S.RES ERJ3GEYJ 473 V (47K)	T	229.2/12.6
R9164	7030003360	S.RES ERJ3GEYJ 221 V (220)	T	233.3/11.9
R9165	7030005871	S.RES ERA3YKD 104V (100K)	T	244.6/12.7
R9166	7030005871	S.RES ERA3YKD 104V (100K)	T	243.3/12.7
R9167	7030005871	S.RES ERA3YKD 104V (100K)	T	245.9/12.7
R9168	7030005871	S.RES ERA3YKD 104V (100K)	T	247.2/12.7
R9169	7030005871	S.RES ERA3YKD 104V (100K)	T	247.2/17.2
R9170	7030005871	S.RES ERA3YKD 104V (100K)	T	245.9/17.2
R9171	7030005871	S.RES ERA3YKD 104V (100K)	T	243.3/17.2
R9172	7030005871	S.RES ERA3YKD 104V (100K)	T	244.6/17.2
C1	4030007110	S.CER C1608 CH 1H 680J-T	T	204.3/130.1
C2	4030007120	S.CER C1608 CH 1H 820J-T	T	200.5/130.1
C3	4030007150	S.CER C1608 CH 1H 151J-T	T	200.5/132.9
C4	4030007050	S.CER C1608 CH 1H 220J-T	T	198.6/132.7
C5	4030007120	S.CER C1608 CH 1H 820J-T	T	198.6/134
C6	4030011600	S.CER C1608 JB 1E 104K-T	T	191.7/131.1
C7	4030011600	S.CER C1608 JB 1E 104K-T	T	196.5/133.7
C8	4030011600	S.CER C1608 JB 1E 104K-T	T	191.7/129.8
C9	4030011600	S.CER C1608 JB 1E 104K-T	T	188.5/130.7
C10	4030011600	S.CER C1608 JB 1E 104K-T	T	186.6/133.8
C11	4030011600	S.CER C1608 JB 1E 104K-T	T	184/133.8
C54	4030011600	S.CER C1608 JB 1E 104K-T	T	171.5/129.5
C56	4030006870	S.CER C1608 JB 1H 222K-T	T	174.2/129.5
C57	4030006900	S.CER C1608 JB 1H 103K-T	T	175.1/131.4
C59	4030010020	S.CER C1608 JB 1H 122K-T	T	176.9/129.5
C61	4030008860	S.CER C1608 JB 1H 153K-T	T	176.4/131.4
C62	4030006870	S.CER C1608 JB 1H 222K-T	T	179.7/130.8
C63	4030008860	S.CER C1608 JB 1H 153K-T	T	177.7/131.4
C64	4030011600	S.CER C1608 JB 1E 104K-T	T	166.5/124.6
C65	4030011600	S.CER C1608 JB 1E 104K-T	T	183.3/127.8
C66	4030011600	S.CER C1608 JB 1E 104K-T	T	168.4/127.9
C67	4030011600	S.CER C1608 JB 1E 104K-T	T	167.1/127.9
C68	4030011600	S.CER C1608 JB 1E 104K-T	T	163.9/126.4
C101	4030011600	S.CER C1608 JB 1E 104K-T	T	163.6/121.8
C102	4030011600	S.CER C1608 JB 1E 104K-T	T	171.1/123.1
C103	4030011600	S.CER C1608 JB 1E 104K-T	T	178/123.1
C104	4030011600	S.CER C1608 JB 1E 104K-T	T	185/123.1
C105	4030011600	S.CER C1608 JB 1E 104K-T	T	191.8/123.2
C106	4030011600	S.CER C1608 JB 1E 104K-T	T	198.5/123.3
C107	4030011600	S.CER C1608 JB 1E 104K-T	T	205.5/123.3
C108	4030011600	S.CER C1608 JB 1E 104K-T	T	211.7/124.4
C109	4030006870	S.CER C1608 JB 1H 222K-T	T	158.5/116.6
C110	4030009980	S.CER C1608 JB 1H 152K-T	T	163.7/119.7
C111	4030010040	S.CER C1608 JB 1H 561K-T	T	172.2/118.8
C112	4030010040	S.CER C1608 JB 1H 561K-T	T	179.4/120.1
C113	4030006850	S.CER C1608 JB 1H 471K-T	T	186.1/120
C114	4030011330	S.CER C1608 CH 1H 391J-T	T	192.9/120.1
C115	4030007170	S.CER C1608 CH 1H 221J-T	T	199.6/120.1
C116	4030007130	S.CER C1608 CH 1H 101J-T	T	205.2/119.6
C117	4030007150	S.CER C1608 CH 1H 151J-T	T	213.3/120.8
C118	4030011280	S.CER C1608 CH 1H 271J-T	T	172.2/120.1
C119	4030011280	S.CER C1608 CH 1H 271J-T	T	159.3/114.7
C120	4030007130	S.CER C1608 CH 1H 101J-T	T	166.3/119.7
C121	4030007130	S.CER C1608 CH 1H 101J-T	T	179.4/118.8
C122	4030007100	S.CER C1608 CH 1H 560J-T	T	186.1/118.7
C123	4030007080	S.CER C1608 CH 1H 390J-T	T	192.9/118.8
C124	4030007090	S.CER C1608 CH 1H 470J-T	T	199.6/118.8
C125	4030007050	S.CER C1608 CH 1H 220J-T	T	207.1/120.1
C126	4030007040	S.CER C1608 CH 1H 180J-T	T	213.3/119.5
C127	4030008920	S.CER C1608 JB 1H 473K-T	T	162/112.5
C128	4030009970	S.CER C1608 JB 1H 182K-T	T	158.5/112.7
C129	4030009980	S.CER C1608 JB 1H 152K-T	T	169/114.3
C130	4030009980	S.CER C1608 JB 1H 152K-T	T	164.6/117.5
C131	4030009980	S.CER C1608 JB 1H 152K-T	T	171.8/115.4
C132	4030007140	S.CER C1608 CH 1H 121J-T	T	174.1/114.8
C133	4030010040	S.CER C1608 JB 1H 561K-T	T	171.1/117.4
C134	4030006850	S.CER C1608 JB 1H 471K-T	T	178.3/117.4
C135	4030010760	S.CER C1608 JB 1H 331J-T	T	185/117.3
C136	4030011280	S.CER C1608 CH 1H 271J-T	T	192.8/114.4
C137	4030007150	S.CER C1608 CH 1H 151J-T	T	191.8/115.7
C138	4030011280	S.CER C1608 CH 1H 271J-T	T	199.1/115.5
C139	4030007170	S.CER C1608 CH 1H 221J-T	T	198.4/117.4
C140	4030007160	S.CER C1608 CH 1H 181J-T	T	205.7/116.4
C141	4030007160	S.CER C1608 CH 1H 181J-T	T	205/118.3
C142	4030007150	S.CER C1608 CH 1H 151J-T	T	212.8/115.5
C143	4030007130	S.CER C1608 CH 1H 101J-T	T	212.1/117.4
C144	4030007140	S.CER C1608 CH 1H 121J-T	T	181.4/114.8
C145	4030010040	S.CER C1608 JB 1H 561K-T	T	179/115.5
C146	4030006850	S.CER C1608 JB 1H 471K-T	T	185.7/115.2
C147	4030008850	S.CER C1608 JB 1H 123K-T	T	164.5/116.1

[MAIN UNIT]

REF NO.	PARTS NO.	DESCRIPTION	M.	H/V LOCATION
C148	4030006880	S.CER C1608 JB 1H 472K-T	T	171.1/113
C149	4030009970	S.CER C1608 JB 1H 182K-T	T	178.4/112.9
C150	4030006870	S.CER C1608 JB 1H 222K-T	T	186.1/113.3
C151	4030006870	S.CER C1608 JB 1H 222K-T	T	192.7/113.1
C152	4030009980	S.CER C1608 JB 1H 152K-T	T	199.5/113.6
C153	4030009980	S.CER C1608 JB 1H 152K-T	T	205.5/114.4
C154	4030006860	S.CER C1608 JB 1H 102K-T	T	213.3/113.5
C155	4030009980	S.CER C1608 JB 1H 152K-T	T	168.4/111.7
C156	4030011600	S.CER C1608 JB 1E 104K-T	T	163.8/113.9
C157	4030006870	S.CER C1608 JB 1H 222K-T	T	171.1/111.7
C158	4030009980	S.CER C1608 JB 1H 152K-T	T	178.1/111
C159	4030006880	S.CER C1608 JB 1H 472K-T	T	186.1/112
C160	4030007170	S.CER C1608 CH 1H 221J-T	T	196.5/110.7
C161	4030011600	S.CER C1608 JB 1E 104K-T	T	191.9/110.8
C162	4030007160	S.CER C1608 CH 1H 181J-T	T	202.7/110.3
C163	4030011600	S.CER C1608 JB 1E 104K-T	T	199.5/112.2
C164	4030007150	S.CER C1608 CH 1H 151J-T	T	210.6/112.6
C165	4030011600	S.CER C1608 JB 1E 104K-T	T	205.5/113
C166	4030007130	S.CER C1608 CH 1H 101J-T	T	217.2/109.9
C167	4030011600	S.CER C1608 JB 1E 104K-T	T	213.3/112.1
C168	4030011600	S.CER C1608 JB 1E 104K-T	T	158.9/121.1
C169	4030006860	S.CER C1608 JB 1H 102K-T	T	175.5/112.5
C170	4030011600	S.CER C1608 JB 1E 104K-T	T	171.1/109.9
C171	4030006850	S.CER C1608 JB 1H 471K-T	T	182.4/112.9
C172	4030011600	S.CER C1608 JB 1E 104K-T	T	178.1/109.7
C173	4030010760	S.CER C1608 CH 1H 331J-T	T	189.1/110.3
C174	4030011600	S.CER C1608 JB 1E 104K-T	T	184.3/110.1
C175	4030007040	S.CER C1608 CH 1H 180J-T	T	199.7/121.4
C176	4030010020	S.CER C1608 JB 1H 122K-T	T	167.7/114.3
C177	4030007130	S.CER C1608 CH 1H 101J-T	T	205.2/120.9
C178	4030007130	S.CER C1608 CH 1H 101J-T	T	165/119.7
C179	4030007150	S.CER C1608 CH 1H 151J-T	T	191.8/117
C201	4030011600	S.CER C1608 JB 1E 104K-T	T	190.2/104.7
C202	4030007120	S.CER C1608 CH 1H 820J-T	T	192.7/97.9
C203	4030007050	S.CER C1608 CH 1H 220J-T	T	190/97.9
C204	4030007150	S.CER C1608 CH 1H 151J-T	T	189.2/96
C205	4030009910	S.CER C1608 CH 1H 040B-T	T	183.5/101.9
C206	4030007130	S.CER C1608 CH 1H 101J-T	T	188/101.8
C207	4030011600	S.CER C1608 JB 1E 104K-T	T	182/96.5
C208	4030006880	S.CER C1608 JB 1H 472K-T	T	216/59.1
C209	4030011600	S.CER C1608 JB 1E 104K-T	T	185.5/86.5
C210	4030011600	S.CER C1608 JB 1E 104K-T	T	178.4/86.4
C211	4030006880	S.CER C1608 JB 1H 472K-T	T	216.1/51.2
C212	4030011600	S.CER C1608 JB 1E 104K-T	T	186.1/72.1
C213	4030009910	S.CER C1608 CH 1H 040B-T	T	180/74.9
C214	4030006860	S.CER C1608 JB 1H 102K-T	T	191.1/77.3
C215	4030006970	S.CER C1608 CH 1H 060D-T	T	170.3/64.3
C217	4030006960	S.CER C1608 CH 1H 050C-T	T	188.6/54.9
C218	4030006880	S.CER C1608 JB 1H 472K-T	T	184.4/49.1
C219	4030006880	S.CER C1608 JB 1H 472K-T	T	192.7/51.4
C220	4030006880	S.CER C1608 JB 1H 472K-T	T	191.2/51.5
C221	4030006880	S.CER C1608 JB 1H 472K-T	T	192.4/57.9
C223	4030006880	S.CER C1608 JB 1H 472K-T	T	202.5/49.3
C224	4030006880	S.CER C1608 JB 1H 472K-T	T	186.3/47.7
C225	4030006970	S.CER C1608 CH 1H 060D-T	T	170.3/63
C226	4030009910	S.CER C1608 CH 1H 040B-T	T	182.2/101.9
C227	4030006960	S.CER C1608 CH 1H 050C-T	T	180/77.5
C301	4030006880	S.CER C1608 JB 1H 472K-T	T	206.1/50.8
C302	4030006970	S.CER C1608 CH 1H 060D-T	T	211.3/43.9
C303	4030006960	S.CER C1608 CH 1H 050C-T	T	200/43.2
C305	4030006850	S.CER C1608 JB 1H 471K-T	T	160/54.7
C307	4030011280	S.CER C1608 CH 1H 271J-T	T	158.7/63.6
C308	4030009580	S.CER C1608 JB 1H 681K-T	T	161.5/64.9
C309	4030011600	S.CER C1608 JB 1E 104K-T	T	159.3/65.6
C310	4030006880	S.CER C1608 JB 1H 472K-T	T	163.7/68.4
C311	4030009970	S.CER C1608 JB 1H 182K-T	T	158.2/71.7
C312	4030011600	S.CER C1608 JB 1E 104K-T	T	209.2/59.2
C314	4030006860	S.CER C1608 JB 1H 102K-T	T	164.8/54.6
C315	4030006870	S.CER C1608 JB 1H 222K-T	T	159.5/71.7
C401	4030011600	S.CER C1608 JB 1E 104K-T	T	164.6/75.5
C402	4030006880	S.CER C1608 JB 1H 472K-T	T	141/98.7

[MAIN UNIT]

REF NO.	PARTS NO.	DESCRIPTION	M.	H/V LOCATION
C604	4030006860	S.CER C1608 JB 1H 102K-T	T	204.4/75.1
C605	4030010760	S.CER C1608 CH 1H 331J-T	T	196.9/75.3
C606	4030007010	S.CER C1608 CH 1H 100D-T	T	202.5/74.3
C607	4030009510	S.CER C1608 CH 1H 010B-T	T	202.3/71.8
C608	4030007010	S.CER C1608 CH 1H 100D-T	T	197.8/72.2
C609	4030006970	S.CER C1608 CH 1H 060D-T	T	195.9/71.7
C610	4030009510	S.CER C1608 CH 1H 010B-T	T	195.7/73
C611	4030011600	S.CER C1608 JB 1E 104K-T	T	191.2/69.3
C612	4030007060	S.CER C1608 CH 1H 270J-T	T	205.2/78.2
C701	4030011600	S.CER C1608 JB 1E 104K-T	T	199.7/95.4
C702	4030011600	S.CER C1608 JB 1E 104K-T	T	204.9/104.1
C703	4030011600	S.CER C1608 JB 1E 104K-T	T	201/96.7
C705	4030011600	S.CER C1608 JB 1E 104K-T	T	215.2/97.5
C706	4030007060	S.CER C1608 CH 1H 270J-T	T	208.6/97.5
C707	4030006970	S.CER C1608 CH 1H 060D-T	T	210.4/99.5
C709	4030007080	S.CER C1608 CH 1H 390J-T	T	211.2/97.5
C710	4030007040	S.CER C1608 CH 1H 180J-T	T	215.5/100.6
C711	4030007050	S.CER C1608 CH 1H 220J-T	T	213.3/97.5
C712	4030011600	S.CER C1608 JB 1E 104K-T	T	206.5/81
C714	4030011600	S.CER C1608 JB 1E 104K-T	T	199.6/67.6
C715	4030006960	S.CER C1608 CH 1H 050C-T	T	210.2/73.7
C716	4030006860	S.CER C1608 JB 1H 102K-T	T	198.3/67.1
C717	4030006860	S.CER C1608 JB 1H 102K-T	T	207.6/59.2
C718	4030006860	S.CER C1608 JB 1H 102K-T	T	194.2/66.6
C720	4030007080	S.CER C1608 CH 1H 390J-T	T	209.6/55.8
C721	4030006970	S.CER C1608 CH 1H 060D-T	T	209.9/97.5
C801	4030011600	S.CER C1608 JB 1E 104K-T	T	136.3/95.6
C802	4030011600	S.CER C1608 JB 1E 104K-T	T	138.3/98.8
C804	4030006880	S.CER C1608 JB 1H 472K-T	T	132.7/90.3
C805	4030006880	S.CER C1608 JB 1H 472K-T	T	130.6/93
C806	4510009330	S.ELE EEEHA1E470WP	T	154.6/100
C901	4030011600	S.CER C1608 JB 1E 104K-T	T	80.5/77.3
C902	4030011600	S.CER C1608 JB 1E 104K-T	T	85.5/75.4
C903	4030006880	S.CER C1608 JB 1H 472K-T	T	79.7/79.9
C904	4030011600	S.CER C1608 JB 1E 104K-T	T	85.4/80
C905	4030011600	S.CER C1608 JB 1E 104K-T	T	75.8/83
C906	4030011600	S.CER C1608 JB 1E 104K-T	T	77.9/78.2
C907	4030011600	S.CER C1608 JB 1E 104K-T	T	77.1/79.9
C908	4510008970	S.ELE EEEHB1C100R	T	78.3/88.2
C909	4030011600	S.CER C1608 JB 1E 104K-T	T	74.5/83
C910	4030011600	S.CER C1608 JB 1E 104K-T	T	82.6/87.6
C1001	4030011600	S.CER C1608 JB 1E 104K-T	T	74.4/54.2
C1002	4030011600	S.CER C1608 JB 1E 104K-T	T	76.2/58.3
C1003	4030011600	S.CER C1608 JB 1E 104K-T	T	81.7/57.3
C1004	4030009970	S.CER C1608 JB 1H 182K-T	T	79/59.6
C1005	4030010040	S.CER C1608 JB 1H 561K-T	T	79/58.3
C1006	4030006880	S.CER C1608 JB 1H 472K-T	T	81.7/59.9
C1007	4030006880	S.CER C1608 JB 1H 472K-T	T	81.7/58.6
C1008	4030006880	S.CER C1608 JB 1H 472K-T	T	87/63.8
C1010	4510008970	S.ELE EEEHB1C100R	T	92.3/56.1
C1011	4510008970	S.ELE EEEHB1C100R	T	83.5/69.6
C1012	4030011600	S.CER C1608 JB 1E 104K-T	T	89.8/68.6
C1051	4510008970	S.ELE EEEHB1C100R	T	67.6/47.7
C1052	4510008970	S.ELE EEEHB1C100R	T	79.7/40.8
C1054	4030006900	S.CER C1608 JB 1H 103K-T	T	78.7/48.9
C1055	4030006860	S.CER C1608 JB 1H 102K-T	T	77.4/49
C1056	4030008880	S.CER C1608 JB 1H 223K-T	T	74.8/50
C1057	4030008880	S.CER C1608 JB 1H 223K-T	T	73.5/50
C1058	4030008880	S.CER C1608 JB 1H 223K-T	T	80.3/48.1
C1059	4030006900	S.CER C1608 JB 1H 103K-T	T	78.9/45.9
C1061	4030006860	S.CER C1608 JB 1H 102K-T	T	76/40
C1062	4030008880	S.CER C1608 JB 1H 223K-T	T	72.1/40
C1063	4030008880	S.CER C1608 JB 1H 223K-T	T	73.4/40
C1064	4030008880	S.CER C1608 JB 1H 223K-T	T	70.7/44.1
C1101	4030011600	S.CER C1608 JB 1E 104K-T	T	41.9/88.6
C1102	4030011600	S.CER C1608 JB 1E 104K-T	T	48.1/80
C1201	4030006880	S.CER C1608 JB 1H 472K-T	T	128.1/112.9
C1202	4030011600	S.CER C1608 JB 1E 104K-T	T	119.2/121.7
C1203	4030011600	S.CER C1608 JB 1E 104K-T	T	114.4/109.1
C1205	4510008970	S.ELE EEEHB1C100R	T	132.4/111
C1206	4030006860	S.CER C1608 JB 1H 102K-T	T	133.7/114.9
C1208	4030006880	S.CER C2012 JF 1C 105Z-T	T	133.2/120.3
C1209	4030011600	S.CER C1608 JB 1E 104K-T	T	142.7/123
C1210	4030008680	S.CER C2012 JF 1C 105Z-T	T	129.7/120.3
C1211	4030008680	S.CER C2012 JF 1C 105Z-T	T	131.5/120.3
C1212	4030008680	S.CER C2012 JF 1C 105Z-T	T	136/115.2
C1213	4030008680	S.CER C2012 JF 1C 105Z-T	T	136.3/113.4
C1214	4030011600	S.CER C1608 JB 1E 104K-T	T	119.7/110.4
C1221	4030007130	S.CER C1608 CH 1H 101J-T	T	115.3/120.4
C1301	4030011600	S.CER C1608 JB 1E 104K-T	T	94.6/133.8
C1302	4030011600	S.CER C1608 JB 1E 104K-T	T	95.9/133.8
C1303	4030011600	S.CER C1608 JB 1E 104K-T	T	97.2/133.8
C1304	4030011600	S.CER C1608 JB 1E 104K-T	T	98.5/133.8
C1305	4030011600	S.CER C1608 JB 1E 104K-T	T	99.8/133.8
C1306	4030011600	S.CER C1608 JB 1E 104K-T	T	101.1/133.8
C1307	4030011600	S.CER C1608 JB 1E 104K-T	T	102.4/133.8
C1308	4030011600	S.CER C1608 JB 1E 104K-T	T	103.7/133.8
C1309	4030011600	S.CER C1608 JB 1E 104K-T	T	105.6/123.2
C1310	4030011600	S.CER C1608 JB 1E 104K-T	T	174.3/93.2
C1311	4030011600	S.CER C1608 JB 1E 104K-T	T	63.6/115.1
C1312	4510009330	S.ELE EEEHA1E470WP	T	176.3/102.5
C1313	4510009310	S.ELE EEEHB1E4R7R	T	77.3/110.8
C1314	4510009330	S.ELE EEEHA1E470WP	T	59.5/98.9
C1315	4030011600	S.CER C1608 JB 1E 104K-T	T	159.3/104.1
C1451	4030011600	S.CER C1608 JB 1E 104K-T	T	19.3/29.3
C1501	4510009330	S.ELE EEEHA1E470WP	T	15.4/69.2
C1502	4030011600	S.CER C1608 JB 1E 104K-T	T	11.5/73.5
C1503	4030011600	S.CER C1608 JB 1E 104K-T	T	12.4/77.4
C1504	4510008970	S.ELE EEEHB1C100R	T	4.4/85
C1505	4510008970	S.ELE EEEHB1C100R	T	146.4/119.5
C1506	4030011600	S.CER C1608 JB 1E 104K-T	T	147.5/115.8
C1507	4030011600	S.CER C1608 JB 1E 104K-T	T	156.5/114.4
C1508	4510009330	S.ELE EEEHA1E470WP	T	154.4/108.3
C1509	4030008680	S.CER C2012 JF 1C 105Z-T	T	87.4/116.6

[MAIN UNIT]

REF NO.	PARTS NO.	DESCRIPTION	M.	H/V LOCATION
C1510	4030008680	S.CER C2012 JF 1C 105Z-T	T	86.2/125
C1551	4030008680	S.CER C2012 JF 1C 105Z-T	T	76.6/132.7
C1552	4510009330	S.ELE EEEHA1E470WP	T	75.2/121.2
C1555	4510009330	S.ELE EEEHA1E470WP	T	67.5/122.5
C1557	4030011600	S.CER C1608 JB 1E 104K-T	T	51.9/132.4
C1558	4510008970	S.ELE EEEHB1C100R	T	55.8/122.4
C1559	4030011600	S.CER C1608 JB 1E 104K-T	T	56.7/126
C1560	4030011600	S.CER C1608 JB 1E 104K-T	T	64.7/127
C1561	4030007170	S.CER C1608 CH 1H 221J-T	T	62.6/129
C1562	4030011600	S.CER C1608 JB 1E 104K-T	T	59.3/119
C1563	4030007170	S.CER C1608 CH 1H 221J-T	T	63.9/129
C1601	4510006640	ELE 16 ME 1000 CZ	T	
C1602	4030011600	S.CER C1608 JB 1E 104K-T	T	5.7/42.9
C1603	4510009350	S.ELE EEEHA1C471P	T	12.7/38.4
C1604	4510009350	S.ELE EEEHA1C471P	T	5.6/67.4
C1605	4510009350	S.ELE EEEHA1C471P	T	16.4/60.1
C1606	4030006900	S.CER C1608 JB 1H 103K-T	T	2.9/30.8
C1607	4510008970	S.ELE EEEHB1C100R	T	4.8/20.9
C1608	4030011600	S.CER C1608 JB 1E 104K-T	T	21.1/22.6
C1609	4030008680	S.CER C2012 JF 1C 105Z-T	T	26.2/24
C1610	4030011600	S.CER C1608 JB 1E 104K-T	T	23.3/27.4
C1611	4030008680	S.CER C2012 JF 1C 105Z-T	T	45.2/22.6
C1612	4510009310	S.ELE EEEHB1E4R7R	T	38/32.2
C1613	4030011600	S.CER C1608 JB 1E 104K-T	T	39.7/28.4
C1614	4510009350	S.ELE EEEHA1C471P	T	12.7/49.3
C1615	4510008970	S.ELE EEEHB1C100R	T	22.1/40.8
C1616	4510008970	S.ELE EEEHB1C100R	T	22.1/36
C1617	4510008970	S.ELE EEEHB1C100R	T	23.6/46.2
C1618	4030008680	S.CER C2012 JF 1C 105Z-T	T	31.1/49.8
C1619	4030008920	S.CER C1608 JB 1H 473K-T	T	2.9/28
C1621	4510009310	S.ELE EEEHB1E4R7R	T	38/39.8
C1622	4030011600	S.CER C1608 JB 1E 104K-T	T	39.8/36
C1623	4030008680	S.CER C2012 JF 1C 105Z-T	T	31.3/43.3
C1624	4030008680	S.CER C2012 JF 1C 105Z-T	T	28.6/44.6
C1625	4030008680	S.CER C2012 JF 1C 105Z-T	T	26.9/44.6
C1626	4030006880	S.CER C1608 JB 1H 472K-T	T	26.5/22.5
C1627	4030006880	S.CER C1608 JB 1H 472K-T	T	33.1/42.3
C1702	4030011600	S.CER C1608 JB 1E 104K-T	T	28/58.2
C1703	4030011600	S.CER C1608 JB 1E 104K-T	T	23.2/57.9
C1705	4030008680	S.CER C2012 JF 1C 105Z-T	T	34.3/54.3
C1706	4510009310	S.ELE EEEHB1E4R7R	T	41.3/52.1
C1707	4030008850	S.CER C1608 JB 1H 123K-T	T	48.5/50.6
C1709	4030014300	S.CER C1608 JB 1E 563K-T	T	45.9/50.6
C1710	4030014300	S.CER C1608 JB 1E 563K-T	T	45.9/51.9
C1711	4030014300	S.CER C1608 JB 1E 563K-T	T	42.3/39.7
C1713	4510008970	S.ELE EEEHB1C100R	T	38/44.6
C1714	4510008970	S.ELE EEEHB1C100R	T	52.2/50.7
C1715	4030011600	S.CER C1608 JB 1E 104K-T	T	47.8/41.3
C1716	4030011600	S.CER C1608 JB 1E 104K-T	T	74.5/68.1
C1717	4030011600	S.CER C1608 JB 1E 104K-T	T	77.3/62.2
C1718	4030011600	S.CER C1608 JB 1E 104K-T	T	58.1/67.1
C1719	4030011600	S.CER C1608 JB 1E 104K-T	T	61.9/69.7
C1720	4030011600	S.CER C1608 JB 1E 104K-T	T	64.2/68.8
C1721	4030006880	S.CER C1608 JB 1H 472K-T	T	28.8/60.9
C1801	4030011600	S.CER C1608 JB 1E 104K-T	T	134/42.8
C1802	4030006880	S.CER C1608 JB 1H 472K-T	T	143.8/39.1
C1803	4030011600	S.CER C1608 JB 1E 104K-T	T	158.1/22.8
C1804	4030011600	S.CER C1608 JB 1E 104K-T	T	144.3/41.7
C1805	4030011600	S.CER C1608 JB 1E 104K-T	T	147.1/43.5
C1901	4030011600	S.CER C1608 JB 1E 104K-T	T	146.9/124
C1902	4030011600	S.CER C1608 JB 1E 104K-T	T	143.5/125
C1903	4030011600	S.CER C1608 JB 1E 104K-T	T	127.5/122.4
C1904	4030011600	S.CER C1608 JB 1E 104K-T	T	136/125.9
C1905	4030011600	S.CER C1608 JB 1E 104K-T	T	132.9/127.9
C1906	4030011600	S.CER C1608 JB 1E 104K-T	T	122.6/124.5
C1907	4030006880	S.CER C1608 JB 1H 472K-T	T	137.6/128.5
C1908	4030011600	S.CER C1608 JB 1E 104K-T	T	140.8/125
C1909	4030006880	S.CER C1608 JB 1H 472K-T	T	109.9/109.5
C1910	4030006880	S.CER C1608 JB 1H 472K-T	T	119.8/132.9
C1911	4030011600	S.CER C1608 JB 1E 104K-T	T	138.9/128.5
C1912	4510009350	S.ELE EEEHA1C471P	T	156.7/128.2
C1913	4			



[MAIN UNIT]

REF NO.	PARTS NO.	DESCRIPTION	M.	H/V LOCATION
C2209	4030010040	S.CER C1608 JB 1H 561K-T	T	10.2/117.4
C2210	4030007170	S.CER C1608 CH 1H 221J-T	T	41/118
C2211	4030007170	S.CER C1608 CH 1H 221J-T	T	29.4/116.9
C2212	4030007150	S.CER C1608 CH 1H 151J-T	T	8.3/116.3
C2213	4030010020	S.CER C1608 JB 1H 122K-T	T	36/115
C2214	4030007170	S.CER C1608 CH 1H 221J-T	T	25/114.8
C2215	4030007090	S.CER C1608 CH 1H 470J-T	T	2/111.3
C2216	4030006860	S.CER C1608 JB 1H 102K-T	T	44.9/116.2
C2217	4030006870	S.CER C1608 JB 1H 222K-T	T	31.4/116.9
C2218	4030009580	S.CER C1608 JB 1H 681K-T	T	10.2/116.1
C2219	4030007130	S.CER C1608 CH 1H 101J-T	T	38.1/112.2
C2220	4030007160	S.CER C1608 CH 1H 181J-T	T	27.3/111.2
C2221	4030007110	S.CER C1608 CH 1H 680J-T	T	5.9/109.1
C2222	4030010020	S.CER C1608 JB 1H 122K-T	T	39.6/112.2
C2223	4030007160	S.CER C1608 CH 1H 181J-T	T	29.4/111.2
C2224	4030007110	S.CER C1608 CH 1H 680J-T	T	7.3/109.1
C2225	4030010020	S.CER C1608 JB 1H 122K-T	T	42.1/112.6
C2226	4030009980	S.CER C1608 JB 1H 152K-T	T	31.8/108.3
C2227	4030009580	S.CER C1608 JB 1H 681K-T	T	10.4/110.4
C2228	4030007090	S.CER C1608 CH 1H 470J-T	T	39.6/109.5
C2229	4030007030	S.CER C1608 CH 1H 150J-T	T	14.3/118.4
C2232	4030007100	S.CER C1608 CH 1H 560J-T	T	28.6/107.6
C2234	4030011600	S.CER C1608 JB 1E 104K-T	T	39/106.8
C2235	4030011600	S.CER C1608 JB 1E 104K-T	T	20.8/120.9
C2236	4030011330	S.CER C1608 CH 1H 391J-T	T	27.4/104.7
C2237	4030010020	S.CER C1608 JB 1H 122K-T	T	21/119
C2238	4030011600	S.CER C1608 JB 1E 104K-T	T	6.8/104.1
C2239	4030007060	S.CER C1608 CH 1H 270J-T	T	14.3/119.7
C2240	4030011600	S.CER C1608 JB 1E 104K-T	T	42.2/104.3
C2241	4030011600	S.CER C1608 JB 1E 104K-T	T	34.2/105.5
C2242	4030011600	S.CER C1608 JB 1E 104K-T	T	11.3/106.4
C2243	4030006860	S.CER C1608 JB 1H 102K-T	T	21/117.7
C2244	4030007170	S.CER C1608 CH 1H 221J-T	T	19.1/117
C2245	4030007060	S.CER C1608 CH 1H 270J-T	T	14.7/114
C2246	4030006860	S.CER C1608 JB 1H 102K-T	T	21/116.2
C2247	4030007150	S.CER C1608 CH 1H 151J-T	T	16.6/111
C2248	4030007060	S.CER C1608 CH 1H 270J-T	T	17.9/111
C2249	4030006860	S.CER C1608 JB 1H 102K-T	T	21.2/111.2
C2250	4030006860	S.CER C1608 JB 1H 102K-T	T	20.9/114.3
C2251	4030007040	S.CER C1608 CH 1H 180J-T	T	19.3/106.5
C2252	4030011280	S.CER C1608 CH 1H 271J-T	T	15.4/105
C2253	4030010020	S.CER C1608 JB 1H 122K-T	T	19.2/108.4
C2254	4030011600	S.CER C1608 JB 1E 104K-T	T	21.4/105.8
C2263	4030009510	S.CER C1608 CH 1H 010B-T	T	13.4/113.7
C2264	4030009510	S.CER C1608 CH 1H 010B-T	T	19.2/111
C2266	4030007010	S.CER C1608 CH 1H 100D-T	T	8.6/110.9
C2267	4030011600	S.CER C1608 JB 1E 104K-T	T	46.7/103.1
C2268	4030007080	S.CER C1608 CH 1H 390J-T	T	14.1/106.6
C2269	4030007080	S.CER C1608 CH 1H 390J-T	T	4/106.9
C2270	4030011600	S.CER C1608 JB 1E 104K-T	T	11.3/102.8
C2271	4030007090	S.CER C1608 CH 1H 470J-T	T	25.6/105.4
C2272	4030010760	S.CER C1608 CH 1H 331J-T	T	43/117.4
C2301	4030011600	S.CER C1608 JB 1E 104K-T	T	40.4/100.6
C2302	4030011600	S.CER C1608 JB 1E 104K-T	T	45/92.1
C2303	4030011600	S.CER C1608 JB 1E 104K-T	T	30.6/99.3
C2304	4030006850	S.CER C1608 JB 1H 471K-T	T	8.1/98.9
C2307	4030007040	S.CER C1608 CH 1H 180J-T	T	5.2/89.3
C2308	4030007040	S.CER C1608 CH 1H 180J-T	T	32/79.5
C2309	4030007040	S.CER C1608 CH 1H 180J-T	T	12.4/95.6
C2310	4030007130	S.CER C1608 CH 1H 101J-T	T	8.1/96.2
C2311	4030007140	S.CER C1608 CH 1H 121J-T	T	9.6/96.2
C2402	4030006880	S.CER C1608 JB 1H 472K-T	T	33.3/79.5
C2403	4030006880	S.CER C1608 JB 1H 472K-T	T	32.5/76.9
C2404	4030006880	S.CER C1608 JB 1H 472K-T	T	35.4/81.9
C2405	4030009910	S.CER C1608 CH 1H 040B-T	T	40.5/79.1
C2406	4030011600	S.CER C1608 JB 1E 104K-T	T	35.3/84.5
C2409	4030006880	S.CER C1608 JB 1H 472K-T	T	44.1/76
C2501	4030006880	S.CER C1608 JB 1H 472K-T	T	41.4/74.4
C2502	4030006880	S.CER C1608 JB 1H 472K-T	T	47/70.4
C2503	4030011600	S.CER C1608 JB 1E 104K-T	T	47.3/67.7
C2504	4030009910	S.CER C1608 CH 1H 040B-T	T	45.1/67
C2701	4030011600	S.CER C1608 JB 1E 104K-T	T	41.4/69.4
C2702	4030011600	S.CER C1608 JB 1E 104K-T	T	37.5/62.8
C2703	4030011600	S.CER C1608 JB 1E 104K-T	T	42.4/58.4
C2704	4030011600	S.CER C1608 JB 1E 104K-T	T	42.4/61.1
C2705	4510008970	S.ELE EEEHB1C100R	T	40/66.4
C2706	4030011600	S.CER C1608 JB 1E 104K-T	T	40.1/57.6
C2707	4030011600	S.CER C1608 JB 1E 104K-T	T	45.8/53.2
C2708	4030006880	S.CER C1608 JB 1H 472K-T	T	53.6/63.5
C2710	4510008970	S.ELE EEEHB1C100R	T	54.4/68.6
C2711	4510008970	S.ELE EEEHB1C100R	T	57/53.6
C2712	4030006880	S.CER C1608 JB 1H 472K-T	T	62.5/58.9
C2713	4030006880	S.CER C1608 JB 1H 472K-T	T	61.2/58.9
C2714	4030009970	S.CER C1608 JB 1H 182K-T	T	63.2/56.9
C2715	4030010040	S.CER C1608 JB 1H 561K-T	T	63.2/55.6
C2716	4030011600	S.CER C1608 JB 1E 104K-T	T	61.2/61.6
C2717	4030011600	S.CER C1608 JB 1E 104K-T	T	46.3/58.5
C2718	4030011600	S.CER C1608 JB 1E 104K-T	T	45/58.5
C2719	4030011600	S.CER C1608 JB 1E 104K-T	T	49.4/56.2
C3001	4030008920	S.CER C1608 JB 1H 473K-T	T	109.6/87
C3002	4030008920	S.CER C1608 JB 1H 473K-T	T	112.2/87
C3003	4030008920	S.CER C1608 JB 1H 473K-T	T	114.8/87
C3004	4030008920	S.CER C1608 JB 1H 473K-T	T	116.1/87
C3005	4030008920	S.CER C1608 JB 1H 473K-T	T	118.7/87
C3006	4030011600	S.CER C1608 JB 1E 104K-T	T	34.2/46.3
C3007	4030007130	S.CER C1608 CH 1H 101J-T	T	116.5/42.2
C3008	4030011600	S.CER C1608 JB 1E 104K-T	T	32.9/46.3
C3009	4030011600	S.CER C1608 JB 1E 104K-T	T	31.6/46.3
C3101	4510009330	S.ELE EEEHA1E470WP	T	146.1/26.8
C3102	4030011600	S.CER C1608 JB 1E 104K-T	T	141.7/23.5
C3103	4030011600	S.CER C1608 JB 1E 104K-T	T	138.1/23.7
C3104	4510009330	S.ELE EEEHA1E470WP	T	134/26.7
C3201	4030011600	S.CER C1608 JB 1E 104K-T	T	96.2/46.8
C3202	4030006880	S.CER C1608 JB 1H 472K-T	T	90.3/42.1

[MAIN UNIT]

REF NO.	PARTS NO.	DESCRIPTION	M.	H/V LOCATION
C3302	4030011600	S.CER C1608 JB 1E 104K-T	T	119.8/79.7
C3303	4030011600	S.CER C1608 JB 1E 104K-T	T	103.1/70.8
C3304	4030007060	S.CER C1608 CH 1H 472J-T	T	106.5/64.7
C3305	4030007040	S.CER C1608 CH 1H 180J-T	T	106.9/60.8
C3306	4030008850	S.CER C1608 JB 1H 123K-T	T	103.6/64.7
C3307	4030008920	S.CER C1608 JB 1H 473K-T	T	121.3/87
C3308	4030011600	S.CER C1608 JB 1E 104K-T	T	112.4/77.8
C3309	4030006880	S.CER C1608 JB 1H 472K-T	T	112.4/79.2
C3310	4030011600	S.CER C1608 JB 1E 104K-T	T	108.3/63.5
C3311	4030011600	S.CER C1608 JB 1E 104K-T	T	128.6/61.5
C3312	4030009510	S.CER C1608 CH 1H 010B-T	T	99.7/60.9
C3313	4610001830	S.TRI TZBX4N100BA110)	T	98.7/57.4
C3314	4030008860	S.CER C1608 JB 1H 153K-T	T	103.6/66
C3315	4030009510	S.CER C1608 CH 1H 010B-T	T	99.7/62.2
C3316	4030007130	S.CER C1608 CH 1H 101J-T	T	47.1/35.3
C3317	4030007170	S.CER C1608 CH 1H 221J-T	T	45.2/25.7
C3601	4030011600	S.CER C1608 JB 1E 104K-T	T	94.3/59.2
C3602	4030011600	S.CER C1608 JB 1E 104K-T	T	105.4/104.5
C3603	4030011600	S.CER C1608 JB 1E 104K-T	T	92.4/47.4
C3604	4030011600	S.CER C1608 JB 1E 104K-T	T	173.5/79.2
C3605	4030011600	S.CER C1608 JB 1E 104K-T	T	66.8/102.9
C3606	4030011600	S.CER C1608 JB 1E 104K-T	T	70.2/97.7
C3801	4510008970	S.ELE EEEHB1C100R	T	153.9/37.5
C3802	4030011600	S.CER C1608 JB 1E 104K-T	T	134.3/51.4
C3901	4030011600	S.CER C1608 JB 1E 104K-T	T	142.5/55.7
C9001	4030006900	S.CER C1608 JB 1H 103K-T	T	144.9/119
C9002	4030006900	S.CER C1608 JB 1H 103K-T	T	126.8/117
C9003	4030011600	S.CER C1608 JB 1E 104K-T	T	140/11.9
C9004	4030006880	S.CER C1608 JB 1H 472K-T	T	151/11.9
C9005	4030011600	S.CER C1608 JB 1E 104K-T	T	148.2/11.9
C9007	4030011600	S.CER C1608 JB 1E 104K-T	T	142.7/11.9
C9051	4030006880	S.CER C1608 JB 1H 472K-T	T	183.9/23.5
C9052	4030006880	S.CER C1608 JB 1H 472K-T	T	166.7/9.8
C9053	4030006900	S.CER C1608 JB 1H 103K-T	T	204.4/24.6
C9054	4030008680	S.CER C2012 JF 1C 105Z-T	T	169.2/11.6
C9055	4030008680	S.CER C2012 JF 1C 105Z-T	T	172.5/11.6
C9056	4030008680	S.CER C2012 JF 1C 105Z-T	T	175.8/11.6
C9057	4030008680	S.CER C2012 JF 1C 105Z-T	T	166.1/16.1
C9058	4030006900	S.CER C1608 JB 1H 103K-T	T	166.7/7.2
C9060	4030006900	S.CER C1608 JB 1H 103K-T	T	209.8/26.9
C9101	4030006880	S.CER C1608 JB 1H 472K-T	T	29.4/26
C9102	4030006880	S.CER C1608 JB 1H 472K-T	T	32.8/19.8
C9103	4030006900	S.CER C1608 JB 1H 103K-T	T	47.8/13.4
C9151	4030011600	S.CER C1608 JB 1E 104K-T	T	237.7/19.1
C9152	4030011600	S.CER C1608 JB 1E 104K-T	T	256.3/17.4
RL2101	6330001320	REL AHY103		
RL9001	6330001790	REL ATX203		
RL9002	6330001790	REL ATX203		
RL9051	6330001790	REL ATX203		
RL9052	6330001790	REL ATX203		
CP1201	6910009670	S.CHE HK3-S-T	T	115.8/133.5
J1	6510007020	CON TMP-J01X-V6		
J51	6510007020	CON TMP-J01X-V6		
J301	6510007020	CON TMP-J01X-V6		
J601	6510007020	CON TMP-J01X-V6		
J1101	6510021651	CON IMSA-9180B-30B-PT1		
J1102	6510022811	CON IMSA-9180B-22B-PT1		
J1301	6510022561	CON 16FMN-BTRK-A(LF)(SN)		
J1451	6510024311	CON B4B-PH-K-S(LF)(SN)		
J1901	6510025470	CON 20FMN-BTRK-A(LF)(SN)		
J2051	6510009421	CON B9B-ZR(LF)(SN)		
J2101	6510007020	CON TMP-J01X-V6		
J2301	6510007020	CON TMP-J01X-V6		
J3001	6510022631	CON 10FMN-BTRK-A(LF)(SN)		
J3601	6510025480	CON 24FMN-BTRK-A(LF)(SN)		
J3801	6510021861	CON BH-800.4GG <LTC>		
J9001	6510023120	CON CD6109SA1J0 <CVI>		
J9051	6510023120	CON CD6109SA1J0 <CVI>		
J9151	6510023210	CON CD6125SA1J0 <CVI>		
T9003	5920000570	TRA 12T01		
T9004	5920000570	TRA 12T01		
BT1	3020000110	LIT CR2032		
W2101	7030011280	JUM J1/4ZC		
EP1901	6910012350	S.BEA MMZ1608Y 102BT	T	136.3/128.5
EP3001	6910012350	S.BEA MMZ1608Y 102BT	T	126.8/46.3
EP9001	6910012350	S.BEA MMZ1608Y 102BT	T	152.8/22.8</

[PLL UNIT]

REF NO.	PARTS NO.	DESCRIPTION	M.	H/V LOCATION
W5201	8970021851	1.5D300MM-1 C24/C31		
W5601	8970024371	1.5D140MM-1 C24/C31		
W5801	8970024690	1.5D180MM C24/C31		
IC5001	1180001071	S.IC TA7805F(TE16L,Q)	T	65.5/32.6
IC5031	1180001251	S.IC TA7808F(TE16L,Q)	T	31.1/14.7
IC5101	1140007881	S.IC TC190G08FEG0046JDZ/SC1246A	T	158/36.5
IC5102	1130004831	S.IC TC7SU04F(TE85R,F)	T	159.2/22.5
IC5103	1130004831	S.IC TC7SU04F(TE85R,F)	T	170/47.1
IC5401	1130009230	S.IC LMX2306TMX/NOPB	T	203.6/46.3
IC5701	1140004550	S.IC M65343FP/SC1287	T	64.1/65.8
IC5702	1130004831	S.IC TC7SU04F(TE85R,F)	T	56.6/73.7
IC5801	1140004550	S.IC M65343FP/SC1287	T	36.3/60.9
IC5802	1130004831	S.IC TC7SU04F(TE85R,F)	T	45.5/67.2
IC5901	1140004550	S.IC M65343FP/SC1287	T	36.4/34.7
IC5902	1130004831	S.IC TC7SU04F(TE85R,F)	T	44.3/42.2
Q5101	1530002691	S.TRA 2SC4116-GR(TE85R,F)	T	147.5/16
Q5202	1530002601	S.TRA 2SC4215-O(TE85R,F)	T	123.8/39.4
Q5281	1530002601	S.TRA 2SC4215-O(TE85R,F)	T	99.9/55.9
Q5301	1560000331	S.FET 2SK210-GR(TE85R,F)	T	193.7/30.6
Q5302	1530002691	S.TRA 2SC4116-GR(TE85R,F)	T	201/31.6
Q5351	1530002601	S.TRA 2SC4215-O(TE85R,F)	T	196.9/19.3
Q5401	1590001330	S.TRA DTA114EUA T106	T	205.9/50.7
Q5521	1560000491	S.FET 2SK508-T2B-A K52	T	138.7/66.4
Q5553	1530002691	S.TRA 2SC4116-GR(TE85R,F)	T	136/75.1
Q5601	1530002601	S.TRA 2SC4215-O(TE85R,F)	T	177.7/67.9
Q5602	1530002601	S.TRA 2SC4215-O(TE85R,F)	T	182.4/70.9
Q5603	1530002601	S.TRA 2SC4215-O(TE85R,F)	T	188.3/66.5
Q5604	1530002601	S.TRA 2SC4215-O(TE85R,F)	T	184.9/60.7
Q5881	1530003151	S.TRA 2SC4673D-TD-E	T	9.1/66
Q5882	1530002601	S.TRA 2SC4116-O(TE85R,F)	T	19.3/61.1
D5101	1750000271	S.DIO 1SS301(TE85L,F)	T	171.1/40.9
D5301	1790000540	S.VAR MA338(TX)	T	183.5/26.8
D5302	1790001211	S.DIO 1SS375-TL-E	T	200.5/26.7
D5303	1790001211	S.DIO 1SS375-TL-E	T	200.5/22.9
D5402	1750000271	S.DIO 1SS301(TE85L,F)	T	212.9/48.3
D5521	1720000831	S.VAR KV1770STL-G	T	146.9/67.4
FI5101	2020001820	S.CER SFECV10M5FA00-R0 (SFECV10.5MA5S)	T	156.8/16.4
X5251	6050011520	XTA CR-604. POCO 32.000 MHz		
L5005	6200009300	S.COI ELJPA 100KF 10U	T	63.5/12.7
L5021	2040000490	COI EXC-ELDR25C		
L5101	6200001831	S.COI NLV32T-100J	T	172.6/18.8
L5202	6200003261	S.COI NLV32T-101J	T	126.9/47.1
L5203	6150004250	COI LS-471A (C-14922)		
L5204	6150004250	COI LS-471A (C-14922)		
L5301	6200003261	S.COI NLV32T-101J	T	183.7/31.4
L5302	6130001850	COI LB-185		
L5303	6200001831	S.COI NLV32T-100J	T	194.1/33.8
L5304	6200003261	S.COI NLV32T-101J	T	199.4/35.4
L5351	6200003261	S.COI NLV32T-101J	T	206/20.3
L5352	6200003101	S.COI NLV32T-3R9J	T	190.7/18.5
L5401	6200001831	S.COI NLV32T-100J	T	210.4/51
L5521	6170000400	COI LW-38		
L5522	6170000400	COI LW-38		
L5523	6190001281	COI #E544GN-110248		
L5552	6200003261	S.COI NLV32T-101J	T	127.7/58.9
L5601	6200003261	S.COI NLV32T-101J	T	176.3/61.9
L5602	6200003421	S.COI NLV32T-R15J	T	192.1/70.1
L5603	6200003431	S.COI NLV32T-R10J	T	195.1/66.2
L5604	6200003431	S.COI NLV32T-R10J	T	197.8/69.7
L5605	6200003261	S.COI NLV32T-101J	T	180.7/61.8
L5701	6200001831	S.COI NLV32T-100J	T	73.9/73.2
L5781	6200001711	S.COI NLV32T-220J	T	75/49
L5782	6200001711	S.COI NLV32T-220J	T	75.6/54
L5783	6200003151	S.COI NLV32T-180J	T	74.3/59.2
L5801	6200001831	S.COI NLV32T-100J	T	41.4/51.1
L5881	6200001851	S.COI NLV32T-5R6J	T	19.5/50.8
L5882	6200001851	S.COI NLV32T-5R6J	T	24.5/50.2
L5883	6200004900	S.COI ELJFC 5R6K-F	T	29.7/50.9
L5884	6200005011	S.COI NLV25T-100J	T	19.3/67.4
L5885	6200002041	S.COI NLV25T-101J	T	8.7/69.8
L5901	6200001831	S.COI NLV32T-100J	T	41.7/24.9
L5981	6200003151	S.COI NLV32T-180J	T	21.2/24.6
L5982	6200001711	S.COI NLV32T-220J	T	26.1/24
L5983	6200003141	S.COI NLV32T-150J	T	30.2/24.6
R5002	7030003400	S.RES ERJ3GEYJ 471 V (470)	T	82.4/12.3
R5003	7030003400	S.RES ERJ3GEYJ 471 V (470)	T	78.3/14.5
R5004	7030003400	S.RES ERJ3GEYJ 471 V (470)	T	75.7/14.5
R5005	7030003400	S.RES ERJ3GEYJ 471 V (470)	T	73.1/14.5
R5006	7030003400	S.RES ERJ3GEYJ 471 V (470)	T	70.5/14.5
R5008	7030003400	S.RES ERJ3GEYJ 471 V (470)	T	79.6/14.5
R5009	7030003400	S.RES ERJ3GEYJ 471 V (470)	T	77/14.5
R5010	7030003400	S.RES ERJ3GEYJ 471 V (470)	T	74.4/14.5
R5011	7030003400	S.RES ERJ3GEYJ 471 V (470)	T	71.8/14.5
R5021	7070000820	RES ERG1SJ 220 (22)		
R5022	7070000820	RES ERG1SJ 220 (22)		
R5101	7030007200	S.RES ERA3YEB 202V (2K)	T	142/26.7
R5102	7030007200	S.RES ERA3YEB 202V (2K)	T	142/28.3
R5103	7030007200	S.RES ERA3YEB 202V (2K)	T	142/29.9
R5104	7030007200	S.RES ERA3YEB 202V (2K)	T	142/31.5
R5105	7030007200	S.RES ERA3YEB 202V (2K)	T	142/33.1
R5106	7030007220	S.RES ERA3YED 202V (2K)	T	142/34.7
R5107	7030007220	S.RES ERA3YED 202V (2K)	T	142/36.3
R5108	7030007220	S.RES ERA3YED 202V (2K)	T	142/37.9
R5109	7030007220	S.RES ERA3YED 202V (2K)	T	142/39.5
R5110	7030007220	S.RES ERA3YED 202V (2K)	T	142/41.1
R5111	7030007220	S.RES ERA3YED 202V (2K)	T	142/42.7
R5112	7030007220	S.RES ERA3YED 202V (2K)	T	142/44.3
R5113	7030007210	S.RES ERA3YEB 102V (1K)	T	140/27.5
R5114	7030007210	S.RES ERA3YEB 102V (1K)	T	138.7/29.1
R5115	7030007210	S.RES ERA3YEB 102V (1K)	T	140/30.7
R5116	7030007210	S.RES ERA3YEB 102V (1K)	T	138.7/32.3
R5117	7030007210	S.RES ERA3YEB 102V (1K)	T	140/33.9
R5118	7030007230	S.RES ERA3YED 102V (1K)	T	138.7/35.5
R5119	7030007230	S.RES ERA3YED 102V (1K)	T	140/37.1
R5120	7030007230	S.RES ERA3YED 102V (1K)	T	138.7/38.7
R5121	7030007230	S.RES ERA3YED 102V (1K)	T	140/40.3
R5122	7030007230	S.RES ERA3YED 102V (1K)	T	138.7/41.9
R5123	7030007230	S.RES ERA3YED 102V (1K)	T	140/43.5
R5124	7030007220	S.RES ERA3YED 202V (2K)	T	142/45.9
R5125	7030003320	S.RES ERJ3GEYJ 101 V (100)	T	156.7/24.3
R5126	7030003800	S.RES ERJ3GEYJ 105 V (1M)	T	161.9/22.9
R5127	7030003380	S.RES ERJ3GEYJ 331 V (330)	T	162.1/17.1
R5128	7030003320	S.RES ERJ3GEYJ 101 V (100)	T	152.7/22.8
R5129	7030003380	S.RES ERJ3GEYJ 331 V (330)	T	152.2/15.9
R5130	7030003460	S.RES ERJ3GEYJ 152 V (1.5K)	T	145.4/15.8
R5131	7030003400	S.RES ERJ3GEYJ 471 V (470)	T	149.4/15.9
R5132	7030003490	S.RES ERJ3GEYJ 272 V (2.7K)	T	144/15.8
R5133	7030003640	S.RES ERJ3GEYJ 473 V (47K)	T	165.7/25.4
R5134	7030003640	S.RES ERJ3GEYJ 473 V (47K)	T	167.6/25.9
R5135	7030003800	S.RES ERJ3GEYJ 105 V (1M)	T	169.7/34.7
R5136	7030003680	S.RES ERJ3GEYJ 104 V (100K)	T	169.6/43.9
R5137	7030003440	S.RES ERJ3GEYJ 102 V (1K)	T	169.9/31.5
R5138	7030003440	S.RES ERJ3GEYJ 102 V (1K)	T	153.6/46.2
R5139	7030003440	S.RES ERJ3GEYJ 102 V (1K)	T	150.8/49.4
R5140	7030003640	S.RES ERJ3GEYJ 473 V (47K)	T	156/49.4
R5141	7030003640	S.RES ERJ3GEYJ 473 V (47K)	T	153.4/49.4
R5142	7030003640	S.RES ERJ3GEYJ 473 V (47K)	T	150.3/47.5
R5143	7030003640	S.RES ERJ3GEYJ 473 V (47K)	T	157.3/49.4
R5144	7030003640	S.RES ERJ3GEYJ 473 V (47K)	T	154.7/49.4
R5145	7030003640	S.RES ERJ3GEYJ 473 V (47K)	T	152.1/49.4
R5146	7030003430	S.RES ERJ3GEYJ 821 V (820)	T	169.1/35.8
R5203	7030003320	S.RES ERJ3GEYJ 101 V (100)	T	126.3/41.5
R5204	7030003600	S.RES ERJ3GEYJ 223 V (22K)	T	123.6/41.5
R5205	7030003560	S.RES ERJ3GEYJ 103 V (10K)	T	120.7/41.5
R5206	7030003360	S.RES ERJ3GEYJ 221 V (220)	T	120.7/40
R5207	7030003860	S.RES ERJ3GE JPW V	T	124.3/44.8
R5251	7030003400	S.RES ERJ3GEYJ 471 V (470)	T	99.5/64.9
R5252	7030003860	S.RES ERJ3GE JPW V	T	99.9/62.5
R5281	7030003400	S.RES ERJ3GEYJ 471 V (470)	T	99.2/58.9
R5282	7030003320	S.RES ERJ3GEYJ 101 V (100)	T	98/55.7
R5283	7030003480	S.RES ERJ3GEYJ 222 V (2.2K)	T	101.8/56.1
R5284	7030003520	S.RES ERJ3GEYJ 472 V (4.7K)	T	100.5/58.9
R5302	7030003340	S.RES ERJ3GEYJ 151 V (150)	T	185.9/31.9
R5303	7030003680	S.RES ERJ3GEYJ 104 V (100K)	T	189.8/29.4
R5304	7030003680	S.RES ERJ3GEYJ 104 V (100K)	T	191/36
R5305	7030003340	S.RES ERJ3GEYJ 151 V (150)	T	190.1/33.3
R5306	7030003320	S.RES ERJ3GEYJ 101 V (100)	T	195.2/36
R5307	7030003690	S.RES ERJ3GEYJ 124 V (120K)	T	199/31.7
R5308	7030003320	S.RES ERJ3GEYJ 101 V (100)	T	203.8/31.4
R5309	7030003430	S.RES ERJ3GEYJ 821 V (820)	T	204/28.8
R5310	7030003430	S.RES ERJ3GEYJ 821 V (820)	T	204.5/23.2
R5311	7030003430	S.RES ERJ3GEYJ 821 V (820)	T	203.2/26.5
R5312	7030003400	S.RES ERJ3GEYJ 471 V (470)	T	205.8/23.2
R5351	7030003570	S.RES ERJ3GEYJ 123 V (12K)	T	200.1/19.3
R5352	7030003400	S.RES ERJ3GEYJ 471 V (470)	T	198.8/19.3
R5353	7030003440	S.RES ERJ3GEYJ 102 V (1K)	T	201.5/19.3
R5354	7030003400	S.RES ERJ3GEYJ 471 V (470)	T	186.1/19.4
R5401	7030003860	S.RES ERJ3GE JPW V	T	203/49.9
R5403	7030003450	S.RES ERJ3GEYJ 122 V (1.2K)	T	195.6/47.9
R5404	7030003440	S.RES ERJ3GEYJ 102 V (1K)	T	209.7/44.9
R5406	7030003680	S.RES ERJ3GEYJ 104 V (100K)	T	209.7/48.8
R5407	7030003440	S.RES ERJ3GEYJ 102 V (1K)	T	203/51.3
R5408	7030003440	S.RES ERJ3GEYJ 102 V (1K)	T	209.7/46.2
R5409	7030003860	S.RES ERJ3GE JPW V	T	191.6/51.1
R5410	7030003440	S.RES ERJ3GEYJ 102 V (1K)	T	209.7/47.5
R5411	7030003860	S.RES ERJ3GE JPW V	T	198.3/47.9
R5505	70			

[PLL UNIT]

REF NO.	PARTS NO.	DESCRIPTION	M.	H/V LOCATION
R5708	7030007210	S.RES ERA3YEB 102V (1K)	T	67.1/52.9
R5709	7030007210	S.RES ERA3YEB 102V (1K)	T	68.4/54.5
R5710	7030007210	S.RES ERA3YEB 102V (1K)	T	69.7/57.1
R5711	7030007220	S.RES ERA3YED 202V (2K)	T	58/55.5
R5712	7030007220	S.RES ERA3YED 202V (2K)	T	59.3/55.5
R5713	7030007220	S.RES ERA3YED 202V (2K)	T	60.6/55.5
R5714	7030007220	S.RES ERA3YED 202V (2K)	T	61.9/55.5
R5715	7030007220	S.RES ERA3YED 202V (2K)	T	63.2/55.5
R5716	7030007220	S.RES ERA3YED 202V (2K)	T	64.5/55.5
R5717	7030007220	S.RES ERA3YED 202V (2K)	T	65.8/55.5
R5718	7030007200	S.RES ERA3YEB 202V (2K)	T	67.1/55.5
R5719	7030007200	S.RES ERA3YEB 202V (2K)	T	68.4/57.1
R5720	7030007200	S.RES ERA3YEB 202V (2K)	T	72.5/61.5
R5721	7030003800	S.RES ERJ3GEYJ 105 V (1M)	T	59/73.7
R5722	7030003320	S.RES ERJ3GEYJ 101 V (100)	T	60.9/75.1
R5781	7030003410	S.RES ERJ3GEYJ 561 V (560)	T	75.2/45.4
R5782	7030007860	S.RES ERJ3GEYJ 8R2V (8.2)	T	73.8/43.9
R5783	7030003410	S.RES ERJ3GEYJ 561 V (560)	T	75.4/46.7
R5799	7030003440	S.RES ERJ3GEYJ 102 V (1K)	T	72.4/49.1
R5801	7030007220	S.RES ERA3YED 202V (2K)	T	23.4/67.5
R5802	7030007230	S.RES ERA3YED 102V (1K)	T	23.4/66.2
R5803	7030007230	S.RES ERA3YED 102V (1K)	T	23.4/64.9
R5804	7030007230	S.RES ERA3YED 102V (1K)	T	23.4/63.6
R5805	7030007230	S.RES ERA3YED 102V (1K)	T	23.4/62.3
R5806	7030007230	S.RES ERA3YED 102V (1K)	T	23.4/61
R5807	7030007230	S.RES ERA3YED 102V (1K)	T	23.4/59.7
R5808	7030007210	S.RES ERA3YEB 102V (1K)	T	23.4/58.4
R5809	7030007210	S.RES ERA3YEB 102V (1K)	T	25/57.1
R5810	7030007210	S.RES ERA3YEB 102V (1K)	T	27.6/55.8
R5811	7030007220	S.RES ERA3YED 202V (2K)	T	26/67.5
R5812	7030007220	S.RES ERA3YED 202V (2K)	T	26/66.2
R5813	7030007220	S.RES ERA3YED 202V (2K)	T	26/64.9
R5814	7030007220	S.RES ERA3YED 202V (2K)	T	26/63.6
R5815	7030007220	S.RES ERA3YED 202V (2K)	T	26/62.3
R5816	7030007220	S.RES ERA3YED 202V (2K)	T	26/61
R5817	7030007220	S.RES ERA3YED 202V (2K)	T	26/59.7
R5818	7030007200	S.RES ERA3YEB 202V (2K)	T	26/58.4
R5819	7030007200	S.RES ERA3YEB 202V (2K)	T	27.6/57.1
R5820	7030007200	S.RES ERA3YEB 202V (2K)	T	32/52.4
R5821	7030003800	S.RES ERJ3GEYJ 105 V (1M)	T	45.1/69.6
R5822	7030003320	S.RES ERJ3GEYJ 101 V (100)	T	45.4/64.2
R5881	7030000220	S.RES MCR10EZHJ 47 (470)	T	12.9/68.1
R5882	7030003440	S.RES ERJ3GEYJ 102 V (1K)	T	10.3/62.8
R5883	7030003450	S.RES ERJ3GEYJ 122 V (1.2K)	T	13.2/63.3
R5885	7030003370	S.RES ERJ3GEYJ 271 V (270)	T	16.9/58.7
R5886	7030003440	S.RES ERJ3GEYJ 102 V (1K)	T	19.3/59.2
R5887	7030003450	S.RES ERJ3GEYJ 122 V (1.2K)	T	19.3/56.5
R5888	7030003280	S.RES ERJ3GEYJ 470 V (47)	T	20.2/63.9
R5889	7030003450	S.RES ERJ3GEYJ 122 V (1.2K)	T	19.3/53.7
R5890	7030003410	S.RES ERJ3GEYJ 561 V (560)	T	16.9/63.9
R5891	7030003400	S.RES ERJ3GEYJ 471 V (470)	T	19.3/55.1
R5892	7030003260	S.RES ERJ3GEYJ 330 V (33)	T	6.9/60.3
R5901	7030007220	S.RES ERA3YED 202V (2K)	T	23.5/41.3
R5902	7030007230	S.RES ERA3YED 102V (1K)	T	23.5/40
R5903	7030007230	S.RES ERA3YED 102V (1K)	T	23.5/38.7
R5904	7030007230	S.RES ERA3YED 102V (1K)	T	23.5/37.4
R5905	7030007230	S.RES ERA3YED 102V (1K)	T	23.5/36.1
R5906	7030007230	S.RES ERA3YED 102V (1K)	T	23.5/34.8
R5907	7030007230	S.RES ERA3YED 102V (1K)	T	23.5/33.5
R5908	7030007210	S.RES ERA3YEB 102V (1K)	T	23.5/32.2
R5909	7030007210	S.RES ERA3YEB 102V (1K)	T	25.1/30.9
R5910	7030007210	S.RES ERA3YEB 102V (1K)	T	27.7/29.6
R5911	7030007220	S.RES ERA3YED 202V (2K)	T	26.1/41.3
R5912	7030007220	S.RES ERA3YED 202V (2K)	T	26.1/40
R5913	7030007220	S.RES ERA3YED 202V (2K)	T	26.1/38.7
R5914	7030007220	S.RES ERA3YED 202V (2K)	T	26.1/37.4
R5915	7030007220	S.RES ERA3YED 202V (2K)	T	26.1/36.1
R5916	7030007220	S.RES ERA3YED 202V (2K)	T	26.1/34.8
R5917	7030007220	S.RES ERA3YED 202V (2K)	T	26.1/33.5
R5918	7030007200	S.RES ERA3YEB 202V (2K)	T	26.1/32.2
R5919	7030007200	S.RES ERA3YEB 202V (2K)	T	27.7/30.9
R5920	7030007200	S.RES ERA3YEB 202V (2K)	T	32.4/26.1
R5921	7030003800	S.RES ERJ3GEYJ 105 V (1M)	T	44.3/39.8
R5922	7030003320	S.RES ERJ3GEYJ 101 V (100)	T	45.5/38
R5981	7030003860	S.RES ERJ3GGE JPW V	T	18/26.1
R5982	7030003440	S.RES ERJ3GEYJ 102 V (1K)	T	21.4/27.4
C5021	4510009330	S.ELE EEEHA1E470WP	T	57.4/33.6
C5022	4030011600	S.CER C1608 JB 1E 104K-T	T	64.1/25.9
C5023	4030011600	S.CER C1608 JB 1E 104K-T	T	69.7/29.5
C5024	4510009330	S.ELE EEEHA1E470WP	T	72.7/34.6
C5031	4510009330	S.ELE EEEHA1E470WP	T	23.5/15.3
C5032	4030011600	S.CER C1608 JB 1E 104K-T	T	27/10.2
C5033	4030011600	S.CER C1608 JB 1E 104K-T	T	35.2/10.7
C5034	4510009330	S.ELE EEEHA1E470WP	T	38.5/15.3
C5101	4030007060	S.CER C1608 CH 1H 270J-T	T	146.4/29.9
C5102	4030007010	S.CER C1608 CH 1H 100D-T	T	147.6/31.8
C5103	4030006960	S.CER C1608 CH 1H 050C-T	T	147.6/34.5
C5104	4030006880	S.CER C1608 JB 1H 472K-T	T	156.7/21.5
C5105	4030006860	S.CER C1608 JB 1H 102K-T	T	163.5/17.1
C5106	4030006880	S.CER C1608 JB 1H 472K-T	T	148.6/18.1
C5107	4030006880	S.CER C1608 JB 1H 472K-T	T	150.8/15.9
C5108	4030006880	S.CER C1608 JB 1H 472K-T	T	142.6/15.8
C5110	4510008970	S.ELE EEEHB1C100R	T	172.4/14.7
C5111	4030006880	S.CER C1608 JB 1H 472K-T	T	172.4/44.7
C5112	4030007090	S.CER C1608 CH 1H 470J-T	T	168.3/33.9
C5113	4030006880	S.CER C1608 JB 1H 472K-T	T	170.3/29.5
C5115	4030006880	S.CER C1608 JB 1H 472K-T	T	169/29.5
C5116	4510009330	S.ELE EEEHA1E470WP	T	171.9/24.3
C5117	4030006880	S.CER C1608 JB 1H 472K-T	T	168.6/38.1
C5118	4030006880	S.CER C1608 JB 1H 472K-T	T	169.9/38.1
C5120	4030006880	S.CER C1608 JB 1H 472K-T	T	161.1/26.3
C5121	4030006880	S.CER C1608 JB 1H 472K-T	T	159.3/26.3

[PLL UNIT]

REF NO.	PARTS NO.	DESCRIPTION	M.	H/V LOCATION
C5122	4030006880	S.CER C1608 JB 1H 472K-T	T	156.9/26.4
C5123	4030006880	S.CER C1608 JB 1H 472K-T	T	151.9/26.2
C5124	4030006880	S.CER C1608 JB 1H 472K-T	T	150.3/46.2
C5125	4030011600	S.CER C1608 JB 1E 104K-T	T	148.2/43.2
C5126	4030011600	S.CER C1608 JB 1E 104K-T	T	149.1/29.4
C5201	4030006860	S.CER C1608 JB 1H 102K-T	T	127.3/39.2
C5202	4030006860	S.CER C1608 JB 1H 102K-T	T	123.6/42.8
C5203	4030006880	S.CER C1608 JB 1H 472K-T	T	120.7/36.5
C5204	4030006880	S.CER C1608 JB 1H 472K-T	T	120.7/38.7
C5205	4030007030	S.CER C1608 CH 1H 150J-T	T	124.9/36.5
C5206	4030006910	S.CER C1608 CH 1H 0R5C-T	T	119.9/28.2
C5207	4030007030	S.CER C1608 CH 1H 150J-T	T	119.9/23.5
C5251	4030007130	S.CER C1608 CH 1H 101J-T	T	98/66.3
C5253	4030006880	S.CER C1608 JB 1H 472K-T	T	82/70.7
C5254	4510008970	S.ELE EEEHB1C100R	T	84.4/74.6
C5281	4030006880	S.CER C1608 JB 1H 472K-T	T	103.1/56.1
C5282	4030006860	S.CER C1608 JB 1H 102K-T	T	101.8/58.9
C5283	4030006880	S.CER C1608 JB 1H 472K-T	T	111.4/63.8
C5301	4550000730	S.TAN TEESVA OJ 225M8R	T	187.7/33.3
C5302	4030006880	S.CER C1608 JB 1H 472K-T	T	172/34.6
C5303	4030009650	S.CER C1608 CH 1H 240J-T	T	184.2/23.5
C5304	4030011570	S.CER CM105 CH 101G 50AT	T	189.8/26.8
C5305	4610001850	S.TRI TZB4R200AB10R00 (TZB4R200AB110)	T	186.8/25.9
C5306	4030007150	S.CER C1608 CH 1H 151J-T	T	191.1/25.8
C5307	4030007150	S.CER C1608 CH 1H 151J-T	T	191.1/29.8
C5308	4030007150	S.CER C1608 CH 1H 151J-T	T	190.1/32
C5309	4030006880	S.CER C1608 JB 1H 472K-T	T	190.1/34.6
C5310	4030007010	S.CER C1608 CH 1H 100D-T	T	197.1/31.7
C5311	4030006880	S.CER C1608 JB 1H 472K-T	T	205.8/30.6
C5312	4510008970	S.ELE EEEHB1C100R	T	207.8/34.5
C5313	4030006880	S.CER C1608 JB 1H 472K-T	T	203.8/30.1
C5314	4030006880	S.CER C1608 JB 1H 472K-T	T	204.5/26.5
C5315	4030006880	S.CER C1608 JB 1H 472K-T	T	205.8/26.5
C5351	4030006880	S.CER C1608 JB 1H 472K-T	T	203.2/23.2
C5352	4030006880	S.CER C1608 JB 1H 472K-T	T	195/19.4
C5353	4030006880	S.CER C1608 JB 1H 472K-T	T	203/19.3
C5354	4030010000	S.CER C1608 CH 1H 510J-T	T	193.7/19.4
C5355	4030006960	S.CER C1608 CH 1H 050C-T	T	190.7/20.7
C5356	4030010000	S.CER C1608 CH 1H 510J-T	T	187.8/19.4
C5357	4030006880	S.CER C1608 JB 1H 472K-T	T	184.6/19.4
C5401	4030011600	S.CER C1608 JB 1E 104K-T	T	196.9/44
C5402	4030006860	S.CER C1608 JB 1H 102K-T	T	196.9/45.3
C5403	4030006900	S.CER C1608 JB 1H 103K-T	T	198.8/45.8
C5404	4030006880	S.CER C1608 JB 1H 472K-T	T	196.6/46.6
C5408	4550005980	S.TAN TEESVA 1A 475M8R	T	199/50.9
C5521	4610001830	S.TRI TZB4S100AB10R00 (TZB4N100AB110)	T	145.6/72
C5522	4030007130	S.CER C1608 CH 1H 101J-T	T	143.8/66.8
C5523	4030007010	S.CER C1608 CH 1H 100D-T	T	139.6/69.5
C5524	4030006880	S.CER C1608 JB 1H 472K-T	T	144.7/65.4
C5525	4030006870	S.CER C1608 JB 1H 222K-T	T	138/63.2
C5526	4030009510	S.CER C1608 CH 1H 010B-T	T	141.6/65.3
C5528	4030006860	S.CER C1608 JB 1H 102K-T	T	144.5/68.5
C5529	4030011340	S.CER C1608 CH 1H 471J-T	T	140.5/72.2
C5551	4550005980	S.TAN TEESVA 1A 475M8R	T	187.1/49.6
C5552	4550003250	S.TAN TEESVA 1V 474M8R	T	181.6/49.7
C5556	4030006860	S.CER C1608 JB 1H 102K-T	T	150.1/77.5
C5557	4030011600	S.CER C1608 JB 1E 104K-T	T	148.8/75
C5558	4510009370	ELE 16 ME 470 CZ	T	
C5560	4510009320	S.ELE EEEHBOJ220R	T	129.7/72.2
C5561	4030011340	S.CER C1608 CH 1H 471J-T	T	137.9/73.7
C5601	4030006880	S.CER C1608 JB 1H 472K-T	T	176.2/70
C5602	4030006860	S.CER C1608 JB 1H 102K-T	T	175.5/64.7
C5603	4030006880	S.CER C1608 JB 1H 472K-T	T	182.3/66.9
C5604	4030006880	S.CER C1608 JB 1H 472K-T	T	178.5/60.7
C5605	4030006880	S.CER C1608 JB 1H 472K-T	T	184.5/70.6
C5606	4030006860	S.CER C1608 JB 1H 102K-T	T	187.3/68.4
C5607	4030006880	S.CER C1608 JB 1H 472K-T	T	186.4/63.2
C5608	4030006880	S.CER C1608 JB 1H 472K-T	T	187.2/70.6
C5609	4030007090	S.CER C1608 CH 1H 470J-T	T	190.4/63.8
C5610	4030011280	S.CER C1608 CH 1H 271J-T	T	192.2/66.2
C5611	4030007090	S.CER C1608 CH 1H 470J-T	T	193.1/64
C5612	4030007060	S.CER C1608 CH 1H 270J-T	T	194.3/70.9
C5613	4030007020	S.CER C1608 CH 1H 120J-T	T	195.7/64
C5614	4030007060	S.CER C1608 CH 1H 270J-T	T	195.6/70.9
C5615	4030006980	S.CER C1608 CH 1H 070D-T</		

[PLL UNIT]

REF NO.	PARTS NO.	DESCRIPTION	M.	H/V LOCATION
C5807	4030006880	S.CER C1608 JB 1H 472K-T	T	39.2/51.9
C5808	4510008970	S.ELE EEEHB1C100R	T	45.3/53.7
C5809	4030006880	S.CER C1608 JB 1H 472K-T	T	43.2/66.9
C5810	4030006860	S.CER C1608 JB 1H 102K-T	T	46.2/61.6
C5811	4030007010	S.CER C1608 CH 1H 100D-T	T	46.7/64.2
C5812	4030018960	S.CER C3216 JB 1C 106MT-N	T	41.3/69.2
C5881	4030008920	S.CER C1608 JB 1H 473K-T	T	13.2/65.8
C5882	4030007020	S.CER C1608 CH 1H 120J-T	T	18.2/63.9
C5883	4030011600	S.CER C1608 JB 1E 104K-T	T	19.3/57.9
C5884	4030006880	S.CER C1608 JB 1H 472K-T	T	17.1/54.4
C5885	4030006980	S.CER C1608 CH 1H 070D-T	T	21.7/52.8
C5886	4030009500	S.CER C1608 CH 1H 0R5B-T	T	21.7/50.1
C5887	4030006980	S.CER C1608 CH 1H 070D-T	T	23.1/53.1
C5888	4030009510	S.CER C1608 CH 1H 010B-T	T	25.3/52.4
C5889	4030011770	S.CER C1608 CH 1H 060B-T	T	27.5/52
C5890	4030006880	S.CER C1608 JB 1H 472K-T	T	8.2/62
C5891	4030011600	S.CER C1608 JB 1E 104K-T	T	16.9/61.3
C5892	4030011600	S.CER C1608 JB 1E 104K-T	T	11/69.5
C5893	4030007150	S.CER C1608 CH 1H 151J-T	T	5.6/59.7
C5901	4030006880	S.CER C1608 JB 1H 472K-T	T	33.9/42.4
C5902	4030006880	S.CER C1608 JB 1H 472K-T	T	35.7/26.9
C5903	4030006880	S.CER C1608 JB 1H 472K-T	T	37.2/42.4
C5904	4030006880	S.CER C1608 JB 1H 472K-T	T	45/30.5
C5905	4030006880	S.CER C1608 JB 1H 472K-T	T	44.2/35.8
C5906	4030006880	S.CER C1608 JB 1H 472K-T	T	44.2/33.1
C5907	4030006880	S.CER C1608 JB 1H 472K-T	T	39.5/25.6
C5908	4510008970	S.ELE EEEHB1C100R	T	45.6/26.8
C5909	4030006880	S.CER C1608 JB 1H 472K-T	T	41.8/43
C5910	4030006860	S.CER C1608 JB 1H 102K-T	T	46.8/38
C5911	4030007010	S.CER C1608 CH 1H 100D-T	T	46.8/42.1
C5981	4030011600	S.CER C1608 JB 1E 104K-T	T	18.7/27.4
C5982	4030007020	S.CER C1608 CH 1H 120J-T	T	23.4/26.7
C5983	4030009520	S.CER C1608 CH 1H 020B-T	T	23.4/24
C5984	4030007050	S.CER C1608 CH 1H 220J-T	T	25.5/27.5
C5985	4030009530	S.CER C1608 CH 1H 030B-T	T	25.5/26.2
C5986	4030009990	S.CER C1608 CH 1H 200J-T	T	27.5/26.8
J5001	6510022581	S.CON 24FMN-BMTRR-A-TBT(LF)(SN)	T	78/6.5

[PA UNIT]

REF NO.	PARTS NO.	DESCRIPTION	M.	H/V LOCATION
IC6501	1110005450	S.IC TS522IDT	T	112.5/15.7
IC6601	1180001251	S.IC TA7808F(TE16L,Q)	T	119.9/77.5
Q6101	1560001241	S.FET RD01MUS1-T113	T	169.9/48.1
Q6401	1590003040	TRA SD1487		
Q6402	1590003040	TRA SD1487		
Q6403	1540000501	TRA 2SD1585-AZ K		
Q6601	1510001040	S.TRA 2SA1037AKT146S	T	143.8/68.6
Q6602	1590000680	S.TRA DTC114EUA T106	T	139.5/72.7
Q6701	1590000680	S.TRA DTC114EUA T106	T	151.3/27.2
Q6801	1590003051	S.FET PD55003-E	T	158/58
D6701	1160000140	S.DIO DAP222 TL	T	151.5/29.9
L6101	6200003840	S.COI MLF2012D R22K-T	T	179/45.5
L6102	6180000990	COI LAL 04NA 101K		
L6202	6180001240	COI LAL 04NA 820K		
L6204	2040000490	COI EXC-ELDR25C		
L6301	6140003720	COI LR-416 <KN>		
L6303	2040000490	COI EXC-ELDR25C		
L6401	2040000490	COI EXC-ELDR25C		
L6402	2040000490	COI EXC-ELDR25C		
L6403	2040000490	COI EXC-ELDR25C		
L6404	6140003590	COI LR-400 (TR10X5X5 6H3)		
L6405	6140003350	COI LR-376		
L6406	6190001710	COI SK-10M-15X2Y		
L6407	2040000490	COI EXC-ELDR25C		
L6408	6110001730	COI LA-262		
L6501	6200003261	S.COI NLV32T-101J	T	101/13.5
L6701	6200003590	S.COI EXCCL3225U1	T	113.2/6.5
L6702	6200002041	S.COI NLV25T-101J	T	85/9.2
L6703	6200003241	S.COI NLV32T-221J	T	179.7/24.5
L6704	6200003241	S.COI NLV32T-221J	T	175.2/15.2
L6705	6200008820	S.COI HF70ACC 635050-T	T	180/31.6
L6706	6200003241	S.COI NLV32T-221J	T	172.3/10.9
L6707	6200003950	S.COI HF50ACC 322513-T	T	88.3/13.3
L6708	6200003950	S.COI HF50ACC 322513-T	T	80.3/6.3
R6101	7030003270	S.RES ERJ3GEYJ 390 V (39)	T	178.7/42.5
R6102	7030003350	S.RES ERJ3GEYJ 181 V (180)	T	180.6/41.8
R6103	7030003350	S.RES ERJ3GEYJ 181 V (180)	T	180.6/43.3
R6104	7030003300	S.RES ERJ3GEYJ 680 V (68)	T	174.6/47.1
R6105	7030003480	S.RES ERJ3GEYJ 222 V (2.2K)	T	176.4/47.6
R6106	7030003520	S.RES ERJ3GEYJ 472 V (4.7K)	T	174.6/49.7
R6107	7030003420	S.RES ERJ3GEYJ 681 V (680)	T	173.3/49.7
R6109	7030003400	S.RES ERJ3GEYJ 471 V (470)	T	172.4/51.6
R6110	7030000210	S.RES MCR10EZHZJ 39 (390)	T	171.8/54.5
R6111	7030000210	S.RES MCR10EZHZJ 39 (390)	T	171.3/56.3
R6112	7030000210	S.RES MCR10EZHZJ 39 (390)	T	171.2/58
R6201	7030000250	S.RES MCR10EZHZJ 82 (820)	T	164.7/50.6
R6202	7030003510	S.RES ERJ3GEYJ 392 V (3.9K)	T	164.2/46.5
R6203	7030003520	S.RES ERJ3GEYJ 472 V (4.7K)	T	165/48.4
R6204	7030010800	S.RES ERJ1TYJ 2R7U (2.7)	T	153.7/45.1
R6206	7030000340	S.RES MCR10EZHZJ 470 (471)	T	152.7/71.5
R6301	7030000260	S.RES MCR10EZHZJ 100 (101)	T	146.2/48.5
R6302	7030003480	S.RES ERJ3GEYJ 222 V (2.2K)	T	146.7/44
R6303	7030003450	S.RES ERJ3GEYJ 122 V (1.2K)	T	146.7/42.5
R6304	7310005080	S.TRI RH03ADCN3X (3.3K)	T	149.5/40
R6401	7030010260	S.RES ERJ1TYJ 3R3 U	T	92.5/17.5
R6402	7030010260	S.RES ERJ1TYJ 3R3 U	T	92.5/21.5
R6403	7030010260	S.RES ERJ1TYJ 3R3 U	T	93/25.5
R6404	7030010260	S.RES ERJ1TYJ 3R3 U	T	92.5/72.5
R6405	7030010260	S.RES ERJ1TYJ 3R3 U	T	92.5/68.5
R6406	7030010260	S.RES ERJ1TYJ 3R3 U	T	92.9/64.5
R6407	7030001010	S.RES MCR50JZHJ 10 (100)	T	82.8/31.5
R6408	7030001010	S.RES MCR50JZHJ 10 (100)	T	82.7/56.9
R6409	7070000371	RES ERX2SJ 2R2 (2.2)		
R6410	7070000371	RES ERX2SJ 2R2 (2.2)		
R6411	7070000521	RES ERX3SJ 2R7 (2.7)		
R6412	7310005140	S.TRI RH03ADCJ3X (2.2K)	T	127.9/20.6
R6413	7030000300	S.RES MCR10EZHZJ 220 (221)	T	132.8/19
R6502	7030005981	S.RES ERA3YED 333V (33K)	T	119.7/13.2
R6503	7030005981	S.RES ERA3YED 333V (33K)	T	118.7/16.7
R6504	7030005971	S.RES ERA3YKD 683V (68K)	T	120.5/19.7
R6505	7030005971	S.RES ERA3YKD 683V (68K)	T	117.5/18.2
R6507	7030003840	S.RES ERJ3GEYJ 225 V (2.2M)	T	116.7/13
R6509	7030003320	S.RES ERJ3GEYJ 101 V (100)	T	114.5/12.2
R6513	7030003740	S.RES ERJ3GEYJ 334 V (330K)	T	107.7/15.6
R6515	7030003520	S.RES ERJ3GEYJ 472 V (4.7K)	T	103.9/13.9
R6516	7310005020	S.TRI RH03ADC14X (10K)	T	116.2/23.4
R6518	7030003680	S.RES ERJ3GEYJ 104 V (100K)	T	103/18.5
R6602	7030003520	S.RES ERJ3GEYJ 472 V (4.7K)	T	140.6/70.8
R6603	7030003520	S.RES ERJ3GEYJ 472 V (4.7K)	T	140.5/68.6
R6604	7030003580	S.RES ERJ3GEYJ 153 V (15K)	T	137.3/71.8
R6651	7120000510	RES LR20DT10 5LO(5J)		
R6652	7120000510	RES LR20DT10 5LO(5J)		
R6653	7120000510	RES LR20DT10 5LO(5J)		
R6654	7120000510	RES LR20DT10 5LO(5J)		
R6702	7030003520	S.RES ERJ3GEYJ 472 V (4.7K)	T	61.7/7.7
R6704	7030003480	S.RES ERJ3GEYJ 222 V (2.2K)	T	64.5/7
R6801	7030003410	S.RES ERJ3GEYJ 561 V (560)	T	156.2/67.5
R6802	7030004050	S.RES ERJ3GEYJ 1R0 V (1)	T	167.2/57.5
C6101	4030007090	S.CER C1608 CH 1H 470J-T	T	176.4/43.4
C6102	4030007090	S.CER C1608 CH 1H 470J-T	T	176.4/45
C6103	4030011600	S.CER C1608 JB 1E 104K-T	T	176.4/46.3
C6104	4030011600	S.CER C1608 JB 1E 104K-T	T	176.4/48.9
C6105	4030011600	S.CER C1608 JB 1E 104K-T	T	173.3/47.1
C6106	4030011600	S.CER C1608 JB 1E 104K-T	T	176.4/50.4
C6108	4030011600	S.CER C1608 JB 1E 104K-T	T	166.4/46.4
C6109	4030005110	S.CER C2012 JB 1E 473K-T	T	175.6/53

M.=Mounted side (T: Mounted on the Top side, B: Mounted on the Bottom side)  
S.=Surface mount

[PA UNIT]

REF NO.	PARTS NO.	DESCRIPTION	M.	H/V LOCATION
C6201	4030011600	S.CER C1608 JB 1E 104K-T	T	167/50.1
C6202	4030011600	S.CER C1608 JB 1E 104K-T	T	162.9/47.6
C6203	4030004750	S.CER C2012 JB 1H 103K-T	T	158.5/47
C6205	4030008700	S.CER GRM21BB11H473KA01L (GRM40 B)	T	149.7/48
C6206	4030008700	S.CER GRM21BB11H473KA01L (GRM40 B)	T	145.5/74.2
C6301	4030008960	S.CER C2012 JB 1C 104K-T	T	147.2/52.7
C6302	4030011600	S.CER C1608 JB 1E 104K-T	T	146.7/45.5
C6303	4510009370	ELE 16 ME 470 CZ		
C6305	4030011600	S.CER C1608 JB 1E 104K-T	T	110.3/60.2
C6306	4510006640	ELE 16 ME 1000 CZ		
C6307	4320001210	S.MIC UC552H 6800J-T	T	123.2/42.7
C6308	4030011790	S.CER GRM55RF52A684ZD01L (GRM44-1)	T	123.4/57.1
C6401	4030011760	S.CER GRM55R1X2D682JV01L (GRM44-1)	T	93/33.5
C6403	4030011760	S.CER GRM55R1X2D682JV01L (GRM44-1)	T	93/56.5
C6408	4030018370	S.CER ERF22X 6C1H 102J D01L	T	63.2/44.9
C6409	4030018370	S.CER ERF22X 6C1H 102J D01L	T	66.5/44.9
C6410	4030018230	S.CER ERF22X 6C2D 221JD		
C6412	4510006640	ELE 16 ME 1000 CZ		
C6413	4510006640	ELE 16 ME 1000 CZ		
C6414	4030004740	S.CER C2012 JB 1H 472K-T	T	3.6/19
C6415	4030011790	S.CER GRM55RF52A684ZD01L (GRM44-1)	T	16.7/21.3
C6416	4030008920	S.CER C1608 JB 1H 473K-T	T	125/24.5
C6417	4510006640	ELE 16 ME 1000 CZ		
C6418	4030006880	S.CER C1608 JB 1H 472K-T	T	125/23.2
C6419	4030006880	S.CER C1608 JB 1H 472K-T	T	131.2/12
C6424	4030018370	S.CER ERF22X 6C1H 102J D01L	T	93.4/45
C6427	4030011600	S.CER C1608 JB 1E 104K-T	T	149/24.5
C6428	4030011600	S.CER C1608 JB 1E 104K-T	T	83.7/81.3
C6432	4030011740	S.CER GRM32N2C2H201JV01L (GRM42-2 CH)	T	60.9/13.3
C6433	4030011740	S.CER GRM32N2C2H201JV01L (GRM42-2 CH)	T	59.2/78.8
C6501	4030007130	S.CER C1608 CH 1H 101J-T	T	116.7/16
C6503	4030011600	S.CER C1608 JB 1E 104K-T	T	111.2/12.2
C6602	4030006880	S.CER C1608 JB 1H 472K-T	T	139.1/68.6
C6603	4510009370	ELE 16 ME 470 CZ		
C6604	4510009330	S.ELE EEEHA1E470WP	T	104.5/72.5
C6605	4030011600	S.CER C1608 JB 1E 104K-T	T	109.7/76
C6606	4030011600	S.CER C1608 JB 1E 104K-T	T	109.7/79
C6607	4510009330	S.ELE EEEHA1E470WP	T	104.7/80.2
C6608	4030008700	S.CER GRM21BB11H473KA01L (GRM40 B)	T	55.1/6.7
C6609	4510009390	ELE 16 ME 2200 CZ		
C6610	4030017320	S.CER GRM21BB11H104KA01L (GRM40-034)	T	7.8/77.8
C6611	4030004740	S.CER C2012 JB 1H 472K-T	T	7.8/75.5
C6612	4030004720	S.CER C2012 JB 1H 102K-T	T	10.5/79.2
C6701	4030008920	S.CER C1608 JB 1H 473K-T	T	149.1/30.6
C6702	4030008920	S.CER C1608 JB 1H 473K-T	T	59.8/8.4
C6703	4030008920	S.CER C1608 JB 1H 473K-T	T	64.5/5.5
C6704	4030006880	S.CER C1608 JB 1H 472K-T	T	85.6/11.2
C6705	4030006880	S.CER C1608 JB 1H 472K-T	T	110.2/6.5
C6706	4030006880	S.CER C1608 JB 1H 472K-T	T	165.5/6.1
C6707	4030006880	S.CER C1608 JB 1H 472K-T	T	171.7/16.1
C6708	4030006880	S.CER C1608 JB 1H 472K-T	T	176.7/24.6
C6710	4030006880	S.CER C1608 JB 1H 472K-T	T	176.5/27.3
C6711	4030006880	S.CER C1608 JB 1H 472K-T	T	168.2/10
C6712	4030006880	S.CER C1608 JB 1H 472K-T	T	163.5/6.7
C6713	4030006880	S.CER C1608 JB 1H 472K-T	T	167.3/6.8
C6714	4030006880	S.CER C1608 JB 1H 472K-T	T	163.5/5.4
C6715	4030006880	S.CER C1608 JB 1H 472K-T	T	168.2/8.1
C6716	4030007130	S.CER C1608 CH 1H 101J-T	T	169.6/10.3
C6717	4030007130	S.CER C1608 CH 1H 101J-T	T	177.9/27.3
C6718	4030007130	S.CER C1608 CH 1H 101J-T	T	171.7/14.7
C6719	4030007130	S.CER C1608 CH 1H 101J-T	T	176.8/21.6
C6801	4030011600	S.CER C1608 JB 1E 104K-T	T	159/67.5
RL6701	6330001471	REL AJS1311F-K2		
J6301	6510021531	CON IMSA-9230B-1-04Z024-PT1		
J6302	6510021531	CON IMSA-9230B-1-04Z024-PT1		
J6401	6510007020	CON TMP-J01X-V6		
J6411	6510021391	CON IMSA-9230B-1-03Z024-PT1		
J6412	6510021391	CON IMSA-9230B-1-03Z024-PT1		
J6701	6510022541	S.CON 20FMM-BMTTR-A-TBT(LF)(SN)	T	98/8.1
J6702	6510007020	CON TMP-J01X-V6		
J6703	6510003401	CON B04B-EH-S(LF)(SN)		
F6701	5210000061	FUS FGB 5A PBF (FGB0 125V)		
F6702	5220000230	HOL S-N5054 #01		
F6703	5220000230	HOL S-N5054 #01		
S6701	6910006900	THE OHD-3 110M		
W6601	9062700030	WIR 77/98/040/X98/X98		
EP6601	6910000630	BEA FSRH070140RN000B (FSOH070RN)		
EP6602	6510018330	TER F4053A		
EP6603	6510018330	TER F4053A		
EP6701	6910012350	S.BEA MMZ1608Y 102BT	T	95.6/12
EP6702	6910012350	S.BEA MMZ1608Y 102BT	T	94.9/13.3

[PA UNIT]

REF NO.	PARTS NO.	DESCRIPTION	M.	H/V LOCATION
EP6703	6910012350	S.BEA MMZ1608Y 102BT	T	97.6/13.5
EP6704	6910012350	S.BEA MMZ1608Y 102BT	T	84.7/7.3
EP6705	6910012350	S.BEA MMZ1608Y 102BT	T	103.3/16.4
EP6706	6910012350	S.BEA MMZ1608Y 102BT	T	162.9/9.8
EP6707	6910012350	S.BEA MMZ1608Y 102BT	T	165.6/10.1
EP6708	6910012350	S.BEA MMZ1608Y 102BT	T	164.3/9.8
EP6709	6910012350	S.BEA MMZ1608Y 102BT	T	86.6/5.5
EP6710	6910012350	S.BEA MMZ1608Y 102BT	T	166.9/10.1

[DRIVER UNIT]

REF NO.	PARTS NO.	DESCRIPTION	M.	H/V LOCATION
Q6851	1590003061	S.FET PD55015-E	T	9.7/20
R6851	7030010520	S.RES ERJ1TYJ 101U (100)	T	8.2/13.1
R6852	7030000020	S.RES MCR10EZHZ 1 (010)	T	1.9/15.4
C6851	4030004750	S.CER C2012 JB 1H 103K-T	T	14.1/14.1
MP6851	8410002480	S.HEA 2429 PA HEATSINK	B	9.7/20

[VARISTOR-1 UNIT]

REF NO.	PARTS NO.	DESCRIPTION	M.	H/V LOCATION
D6431	1790001760	S.VAR MA30-(TX)	T	3.4/13.5
C6431	4030008920	S.CER C1608 JB 1H 473K-T	T	3.7/11.7

[VARISTOR-2 UNIT]

REF NO.	PARTS NO.	DESCRIPTION	M.	H/V LOCATION
D6432	1790001760	S.VAR MA30-(TX)	T	3.7/13.6
C6432	4030008920	S.CER C1608 JB 1H 473K-T	T	3.8/11.7

M.=Mounted side (T: Mounted on the Top side, B: Mounted on the Bottom side)  
S.=Surface mount

[FILTER UNIT]

REF NO.	PARTS NO.	DESCRIPTION	M.	H/V LOCATION
W7321	8970024710	CBL 1.5D 360MM(1958 FI W7321)		
Q7301	1590000680	S.TRA DTC114EUA T106	B	139.2/88.4
D7271	1750000191	S.DIO 1SS322(TE85R,F)	B	161.2/81.9
D7272	1750000191	S.DIO 1SS322(TE85R,F)	B	161.2/85.5
D7301	1750000550	S.DIO 1SS355 TE-17	B	136.2/92.4
L7031	6200002041	S.COI NLV25T-101J	B	156.5/59.6
L7035	6200002041	S.COI NLV25T-101J	B	148.5/4.5
L7036	6140002240	COI LR-236 (T68-2)		
L7037	6140001990	COI LR-226 (T68-2)		
L7038	6140002000	COI LR-227 (T68-2)		
L7061	6200002041	S.COI NLV25T-101J	B	115.4/64.3
L7065	6200002041	S.COI NLV25T-101J	B	128.2/14.9
L7066	6140002340	COI LR-263 (T68-2)		
L7067	6140002230	COI LR-235 (T68-2)		
L7068	6140002240	COI LR-236 (T68-2)		
L7091	6200002041	S.COI NLV25T-101J	B	96.1/83.8
L7095	6200002041	S.COI NLV25T-101J	B	110.9/15.5
L7096	6140002260	COI LR-238 (T68-2)		
L7097	6140002230	COI LR-235 (T68-2)		
L7098	6140002230	COI LR-235 (T68-2)		
L7121	6200002041	S.COI NLV25T-101J	B	79.7/80.8
L7125	6200002041	S.COI NLV25T-101J	B	96.2/16
L7126	6140002260	COI LR-238 (T68-2)		
L7127	6140002340	COI LR-263 (T68-2)		
L7128	6140002340	COI LR-263 (T68-2)		
L7151	6200005051	S.COI NLV25T-330J	B	64.5/82.4
L7155	6200005051	S.COI NLV25T-330J	B	75/16.8
L7156	6140002280	COI LR-241 (T68-6)		
L7157	6140002250	COI LR-237 (T68-2)		
L7158	6140002250	COI LR-237 (T68-2)		
L7181	6200005051	S.COI NLV25T-330J	B	50.4/89.7
L7182	6140003580	COI LR-399(3.5%)		
L7183	6140003570	COI LR-398 (3.5%)		
L7184	6140003570	COI LR-398 (3.5%)		
L7185	6200005051	S.COI NLV25T-330J	B	57.9/17.6
L7211	6200005011	S.COI NLV25T-100J	B	47.3/89
L7215	6200005011	S.COI NLV25T-100J	B	23.1/30.4
L7216	6140003570	COI LR-398 (3.5%)		
L7217	6140003570	COI LR-398 (3.5%)		
L7218	6140003570	COI LR-398 (3.5%)		
L7241	6200005011	S.COI NLV25T-100J	B	6.3/75.3
L7244	6200005011	S.COI NLV25T-100J	B	16.6/30.5
L7245	6140003780	COI LR-437		
L7246	6140003780	COI LR-437		
L7248	6140003780	COI LR-437		
L7271	6200002041	S.COI NLV25T-101J	B	170.9/80.5
L7272	6140003490	COI LR-391 (TR10X5X5 3A6)		
L7273	6200002041	S.COI NLV25T-101J	B	170.9/87.6
L7321	6140001460	COI LR-170		
L7331	6200002041	S.COI NLV25T-101J	B	24.5/4.6
L7332	6200002041	S.COI NLV25T-101J	B	24.4/10.6
R7271	7030003560	S.RES ERJ3GEYJ 103 V (10K)	B	167.5/81.6
R7272	7030003490	S.RES ERJ3GEYJ 272 V (2.7K)	B	166.7/79.4
R7273	7030003520	S.RES ERJ3GEYJ 472 V (4.7K)	B	163.9/79.4
R7274	7030008190	S.RES ERJ12YJ330U (33)	B	155.4/83.7
R7275	7030003560	S.RES ERJ3GEYJ 103 V (10K)	B	167.5/85.6
R7276	7030003490	S.RES ERJ3GEYJ 272 V (2.7K)	B	166.7/88.8
R7277	7030003520	S.RES ERJ3GEYJ 472 V (4.7K)	B	163.9/88.8
R7301	7030003200	S.RES ERJ3GEYJ 100 V (10)	B	131.3/95.5
R7314	7540000250	ABS SA05C 401N		
R7315	7030010650	S.RES ERJ12YJ823U (82K)	B	159.1/99.4
C7031	4510009360	ELE 50 ME 1 CZ	B	148.9/6.5
C7032	4030011600	S.CER C1608 JB 1E 104K-T	B	157.6/18.8
C7033	4320001220	S.MIC UC552H 1001J-T		
C7034	4010006410	CER HM13SJ SL 471J 500V		
C7035	4010006410	CER HM13SJ SL 471J 500V		
C7036	4320001220	S.MIC UC552H 1001J-T	B	164.4/32.5
C7037	4010005360	CER HM11SJ SL 301J 500V		
C7038	4010005880	CER HM95SJ SL 271J 500V		
C7039	4320001230	S.MIC UC552H 1201J-T	B	161.8/39.2
C7041	4030011120	S.CER GRM31M2C2H100JV01L (GRM42-6 CH)	B	178.5/42.5
C7042	4010005930	CER HM11SJ SL 391J 500V		
C7043	4010005930	CER HM11SJ SL 391J 500V		
C7044	4010005930	CER HM11SJ SL 391J 500V		
C7045	4010005370	CER HM11SJ SL 331J 500V		
C7046	4030011600	S.CER C1608 JB 1E 104K-T	B	159.1/60.6
C7049	4010005850	CER HM95SJ SL 181J 500V		
C7050	4320001230	S.MIC UC552H 1201J-T	B	160.7/26.2
C7051	4320001230	S.MIC UC552H 1201J-T	B	166.5/45.7
C7052	4030011740	S.CER GRM32N2C2H201JV01L (GRM42-2 CH)	B	170/50.7
C7061	4510009360	ELE 50 ME 1 CZ	B	128.6/16.8
C7062	4030011600	S.CER C1608 JB 1E 104K-T	B	144.2/25.7
C7063	4030011730	S.CER GRM31M2C2H101JV01L (GRM42-6 CH)	B	
C7064	4010006410	CER HM13SJ SL 471J 500V		
C7065	4010006410	CER HM13SJ SL 471J 500V		
C7066	4010005370	CER HM11SJ SL 331J 500V		
C7067	4010005880	CER HM95SJ SL 271J 500V		
C7068	4010005880	CER HM95SJ SL 271J 500V		
C7069	4010005880	CER HM95SJ SL 271J 500V		
C7070	4030011730	S.CER GRM31M2C2H101JV01L (GRM42-6 CH)	B	156/30.5
C7071	4010006410	CER HM13SJ SL 471J 500V		

[FILTER UNIT]

REF NO.	PARTS NO.	DESCRIPTION	M.	H/V LOCATION
C7072	4010006410	CER HM13SJ SL 471J 500V		
C7073	4010006410	CER HM13SJ SL 471J 500V		
C7074	4010006410	CER HM13SJ SL 471J 500V		
C7075	4010005370	CER HM11SJ SL 331J 500V		
C7076	4010005370	CER HM11SJ SL 331J 500V		
C7077	4010005370	CER HM11SJ SL 331J 500V		
C7078	4010005930	CER HM11SJ SL 391J 500V		
C7079	4010006410	CER HM13SJ SL 471J 500V		
C7080	4030012480	S.CER GRM31M2C2H121JV01L (GRM42-6 CH)	B	128.4/48.6
C7081	4030012480	S.CER GRM31M2C2H121JV01L (GRM42-6 CH)	B	125.7/48.6
C7082	4010005930	CER HM11SJ SL 391J 500V		
C7083	4010005930	CER HM11SJ SL 391J 500V		
C7084	4030011550	S.CER GRM31M2C2H680JV01L (GRM42-6 CH)	B	138.1/55.1
C7085	4030011600	S.CER C1608 JB 1E 104K-T	B	118.3/61.9
C7086	4030011120	S.CER GRM31M2C2H100JV01L (GRM42-6 CH)	B	144.2/28.3
C7087	4030012480	S.CER GRM31M2C2H121JV01L (GRM42-6 CH)	B	152.3/29
C7091	4510009360	ELE 50 ME 1 CZ		
C7092	4030006880	S.CER C1608 JB 1H 472K-T	B	111/17.5
C7094	4010005370	CER HM11SJ SL 331J 500V		
C7095	4010005930	CER HM11SJ SL 391J 500V		
C7096	4010005930	CER HM11SJ SL 391J 500V		
C7098	4010005370	CER HM11SJ SL 331J 500V		
C7099	4010006410	CER HM13SJ SL 471J 500V		
C7100	4030011730	S.CER GRM31M2C2H101JV01L (GRM42-6 CH)	B	106.6/67.2
C7101	4010005360	CER HM11SJ SL 301J 500V		
C7102	4030006880	S.CER C1608 JB 1H 472K-T	B	102.8/85.3
C7105	4010006410	CER HM13SJ SL 471J 500V		
C7106	4010005830	CER HM74SJ SL 151J 500V		
C7108	4010005370	CER HM11SJ SL 331J 500V		
C7121	4510009360	ELE 50 ME 1 CZ		
C7122	4030006880	S.CER C1608 JB 1H 472K-T	B	93.6/17.5
C7124	4030012480	S.CER GRM31M2C2H121JV01L (GRM42-6 CH)	B	82/29.4
C7125	4010005930	CER HM11SJ SL 391J 500V		
C7126	4030011120	S.CER GRM31M2C2H100JV01L (GRM42-6 CH)	B	85.1/41.7
C7127	4030012480	S.CER GRM31M2C2H121JV01L (GRM42-6 CH)	B	82.5/41.7
C7128	4010005880	CER HM95SJ SL 271J 500V		
C7129	4010005360	CER HM11SJ SL 301J 500V		
C7130	4030011510	S.CER GRM31M2C2H560JV01L (GRM42-6 CH)	B	86.8/67.2
C7131	4030011070	S.CER GRM31M2C2H5R0CY21L (GRM42-6 CH)	B	86.8/64.6
C7132	4010005360	CER HM11SJ SL 301J 500V		
C7133	4030006880	S.CER C1608 JB 1H 472K-T	B	85.4/79.6
C7136	4010005850	CER HM95SJ SL 181J 500V		
C7137	4030011730	S.CER GRM31M2C2H101JV01L (GRM42-6 CH)	B	93.2/28.9
C7151	4510009360	ELE 50 ME 1 CZ		
C7152	4030006880	S.CER C1608 JB 1H 472K-T	B	74/18.7
C7153	4030014460	S.CER GRM31M2C2H820JV01L (GRM42-6 CH)	B	69.2/39.8
C7154	4010005930	CER HM11SJ SL 391J 500V		
C7155	4030012480	S.CER GRM31M2C2H121JV01L (GRM42-6 CH)	B	72.5/55.1
C7156	4030011120	S.CER GRM31M2C2H100JV01L (GRM42-6 CH)	B	74.6/55.1
C7157	4010005930	CER HM11SJ SL 391J 500V		
C7158	4030014460	S.CER GRM31M2C2H820JV01L (GRM42-6 CH)	B	73.2/67.8
C7160	4030006880	S.CER C1608 JB 1H 472K-T	B	67.8/79.5
C7163	4010005850	CER HM95SJ SL 181J 500V		
C7164	4030014460	S.CER GRM31M2C2H820JV01L (GRM42-6 CH)	B	65.8/28.6
C7181	4510009360	ELE 50 ME 1 CZ		
C7182	4030006880	S.CER C1608 JB 1H 472K-T	B	63.3/18.7
C7183	4030012480	S.CER GRM31M2C2H121JV01L (GRM42-6 CH)	B	62.6/24.8
C7184	4030012480	S.CER GRM31M2C2H121JV01L (GRM42-6 CH)	B	53.1/28.8
C7185	4010005880	CER HM95SJ SL 271J 500V		
C7186	4030011510	S.CER GRM31M2C2H560JV01L (GRM42-6 CH)	B	53.1/40.6
C7187	4010005370	CER HM11SJ SL 331J 500V		
C7188	4030011180	S.CER GRM31M2C2H220JV01L (GRM42-6 CH)	B	50.6/68.8
C7190	4030006880	S.CER C1608 JB 1H 472K-T	B	51/85
C7193	4010005850	CER HM95SJ SL 181J 500V		
C7211	4510009360	ELE 50 ME 1 CZ		
C7212	4030006880	S.CER C1608 JB 1H 472K-T	B	25.7/35.3
C7214	4030011240	S.CER GRM31M2C2H470JV01L (GRM42-6 CH)	B	35.6/61.7
C7216	4030011190	S.CER GRM31M2C2H270JV01L (GRM42-6 CH)	B	33.1/75.9
C7217	4030012480	S.CER GRM31M2C2H121JV01L (GRM42-6 CH)	B	29/77.3
C7218	4030006880	S.CER C1608 JB 1H 472K-T	B	44/85.3
C7221	4030014460	S.CER GRM31M2C2H820JV01L (GRM42-6 CH)	B	30.7/45.2
C7222	4010005860	CER HM95SJ SL 201J 500V		
C7223	4030014460	S.CER GRM31M2C2H820JV01L (GRM42-6 CH)	B	30.7/47.4
C7224	4030011210	S.CER GRM31M2C2H330JV01L (GRM42-6 CH)	B	30.3/65.8
C7225	4030011190	S.CER GRM31M2C2H270JV01L (GRM42-6 CH)	B	30.7/42.9
C7241	4030006880	S.CER C1608 JB 1H 472K-T	B	15.3/35.1

M.=Mounted side (T: Mounted on the Top side, B: Mounted on the Bottom side)  
S.=Surface mount

[FILTER UNIT]

REF NO.	PARTS NO.	DESCRIPTION	M.	H/V LOCATION
C7242	4030011730	S.CER GRM31M2C2H101JV01L (GRM42-6 CH)	B	9.2/46.6
C7243	4030011510	S.CER GRM31M2C2H560JV01L (GRM42-6 CH)	B	9.2/48.9
C7244	4030011180	S.CER GRM31M2C2H220JV01L (GRM42-6 CH)	B	8.8/57.7
C7247	4030011190	S.CER GRM31M2C2H270JV01L (GRM42-6 CH)	B	16.3/65.6
C7248	4030011210	S.CER GRM31M2C2H330JV01L (GRM42-6 CH)	B	24.7/60.6
C7249	4030011230	S.CER GRM31M2C2H390JV01L (GRM42-6 CH)	B	24.2/65.8
C7250	4030006880	S.CER C1608 JB 1H 472K-T	B	9.1/80.1
C7253	4010005830	CER HM74SJ SL 151J 500V		
C7254	4030011180	S.CER GRM31M2C2H220JV01L (GRM42-6 CH)	B	8.8/55.6
C7255	4030011080	S.CER GRM31M2C2H6R0DV01L (GRM42-6 CH)	B	8.5/44.3
C7272	4030006900	S.CER C1608 JB 1H 103K-T	B	159/80.3
C7273	4030007090	S.CER C1608 JB 1H 470J-T	B	165.4/86.1
C7274	4030006870	S.CER C1608 JB 1H 222K-T	B	159/87.1
C7275	4610001340	TRI ECR-LA010 A12		
C7277	4010005850	CER HM95SJ SL 181J 500V		
C7278	4030007090	S.CER C1608 CH 1H 470J-T	B	163.2/81.3
C7301	4030006880	S.CER C1608 JB 1H 472K-T	B	136.3/90.7
C7302	4030006880	S.CER C1608 JB 1H 472K-T	B	139.2/86.2
C7303	4030006880	S.CER C1608 JB 1H 472K-T	B	137.1/88.4
C7304	4030006880	S.CER C1608 JB 1H 472K-T	B	129.4/99.2
C7321	4030011730	S.CER GRM31M2C2H101JV01L (GRM42-6 CH)	B	163.9/74
C7322	4030011170	S.CER GRM31M2C2H180JV01L (GRM42-6 CH)	B	166.9/69.3
C7323	4030011730	S.CER GRM31M2C2H101JV01L (GRM42-6 CH)	B	169.7/74
C7325	4030011790	S.CER GRM55RF52A684ZD01L (GRM44-1)	B	155.1/72.6
C7332	4030006880	S.CER C1608 JB 1H 472K-T	B	22.1/10.5
C7345	4030006880	S.CER C1608 JB 1H 472K-T	B	27.1/11.7
RL7031	6330001571	REL AJS1315F-K1		
RL7032	6330001571	REL AJS1315F-K1		
RL7061	6330001571	REL AJS1315F-K1		
RL7062	6330001571	REL AJS1315F-K1		
RL7091	6330001571	REL AJS1315F-K1		
RL7092	6330001571	REL AJS1315F-K1		
RL7121	6330001571	REL AJS1315F-K1		
RL7122	6330001571	REL AJS1315F-K1		
RL7151	6330001571	REL AJS1315F-K1		
RL7152	6330001571	REL AJS1315F-K1		
RL7181	6330001571	REL AJS1315F-K1		
RL7182	6330001571	REL AJS1315F-K1		
RL7211	6330001571	REL AJS1315F-K1		
RL7212	6330001571	REL AJS1315F-K1		
RL7241	6330001571	REL AJS1315F-K1		
RL7242	6330001571	REL AJS1315F-K1		
RL7301	6330000781	REL AGP2013F		
J7001	6510007020	CON TMP-J01X-V6		
J7311	6510007020	CON TMP-J01X-V6		
J7331	6510022561	CON 16FMN-BTRK-A(LF)(SN)		

[REG-DC UNIT]

REF NO.	PARTS NO.	DESCRIPTION	M.	H/V LOCATION
IC301	1110003071	S.IC UPC494GS-E1-A	T	19.1/202.5
IC302	1180002261	S.IC TA78L12F(TE12L,F)	T	40.5/208.2
IC401	1190002250	S.IC TLP131(GB-TPL,F)	T	49.4/111.9
IC402	1190002220	S.IC TLP141G(U,F)	T	55.7/112
IC403	1110001241	S.IC UPC358G2-E1-A	T	54/69
Q101	1590003610	FET STP120NF10		
Q102	1590003610	FET STP120NF10		[EUR-1] only
Q103	1590003610	FET STP120NF10		[EUR-1] only
Q104	1590003610	FET STP120NF10		
Q301	1510000801	S.TRA 2SA1213-Y(TE12R,CF)	T	36.4/192.7
Q302	1510000801	S.TRA 2SA1213-Y(TE12R,CF)	T	37.7/200
Q401	1510000771	S.TRA 2SA1586-GR(TE85L,F)	T	50.8/91.7
D101	1710001230	DIO S3V60-5000		
D102	1730002431	S.ZEN MAZ8150GML	T	37.2/196.2
D103	1730002431	S.ZEN MAZ8150GML	T	38.4/203.4
D201	1710001220	DIO MUR3020WTG		
D202	1710001220	DIO MUR3020WTG		
D203	1790001491	DIO D1NL20U-5070		
D301	1750000291	S.DIO 1SS300(TE85R,F)	T	40.7/192.1
D302	1750000291	S.DIO 1SS300(TE85R,F)	T	41.9/199.4
D303	1790001251	S.DIO MA2S1110GL	T	18.2/214.3
D304	1790001251	S.DIO MA2S1110GL	T	18.2/212.8
D401	1730002321	S.ZEN MAZ8051GML	T	50.4/102.6
D402	1790001251	S.DIO MA2S1110GL	T	48.4/102.4
D403	1790001251	S.DIO MA2S1110GL	T	50.4/99.2
D404	1790001251	S.DIO MA2S1110GL	T	48.4/99.2
D405	1730002321	S.ZEN MAZ8051GML	T	55.3/62.5
D406	1790001251	S.DIO MA2S1110GL	T	49.1/96.7
D407	1790001251	S.DIO MA2S1110GL	T	51.7/97.5
L101	6190001670	COI FK-230N-1020H		
L102	6190001670	COI FK-230N-1020H		[EUR-1] only
L201	6190001700	COI HD3535-1928V		
L202	6140004630	COI LR-522		
L203	6140004630	COI LR-522		
L221	6910000670	COI BL01RN1A1D2B (BL01RN1-A62)		
L222	6910000670	COI BL01RN1A1D2B (BL01RN1-A62)		
R101	7030003720	S.RES ERJ3GEYJ 224 V (220K)	T	172.2/81.2
R102	7070000321	RES ERX1SJ 3R3 (3.3)		
R103	7070000321	RES ERX1SJ 3R3 (3.3)		
R104	7070000251	RES ERX2SJ 4R7 (4.7)		
R105	7070000251	RES ERX2SJ 4R7 (4.7)		
R106	7070000321	RES ERX1SJ 3R3 (3.3)		
R107	7070000321	RES ERX1SJ 3R3 (3.3)		
R108	7070000681	RES ERX3SJ 3R9 (3.9)		[EUR]
R201	7070000900	RES ERX3SJ 1R8 (1.8)		[EUR-1]
R202	7070000601	RES ERG2SJ 470 (47)		
R203	7070000601	RES ERG2SJ 470 (47)		
R204	7120000510	RES LR20DT10 5LO(5J)		
R205	7120000510	RES LR20DT10 5LO(5J)		
R301	7030003440	S.RES ERJ3GEYJ 102 V (1K)	T	32.4/191.9
R302	7030003440	S.RES ERJ3GEYJ 102 V (1K)	T	33.3/199.2
R303	7030007591	S.RES ERA3YKD 433V (43K)	T	12.4/203.6
R304	7030003570	S.RES ERJ3GEYJ 123 V (12K)	T	[EUR-1]
R305	7030006111	S.RES ERA3YED 752V (7.5K)	T	[EUR]
R306	7030003520	S.RES ERJ3GEYJ 472 V (4.7K)	T	[EUR-1]
R307	7030003320	S.RES ERJ3GEYJ 101 V (100)	T	18.9/208.4
R308	7030003520	S.RES ERJ3GEYJ 472 V (4.7K)	T	12.4/206.8
R309	7030003520	S.RES ERJ3GEYJ 472 V (4.7K)	T	10.7/206.8
R310	7030003440	S.RES ERJ3GEYJ 102 V (1K)	T	16.3/208.3
R311	7030003620	S.RES ERJ3GEYJ 333 V (33K)	T	18.2/211.4
R312	7030003490	S.RES ERJ3GEYJ 272 V (2.7K)	T	23/196.7
R313	7030003480	S.RES ERJ3GEYJ 222 V (2.2K)	T	18.5/195.5
R314	7030003610	S.RES ERJ3GEYJ 273 V (27K)	T	55.7/120.2
R315	7030003720	S.RES ERJ3GEYJ 224 V (220K)	T	48.2/118.2
R316	7030003550	S.RES ERJ3GEYJ 822 V (8.2K)	T	11.5/208.9
R317	7030003860	S.RES ERJ3GE JPW V	T	[EUR-1]
R318	7030003390	S.RES ERJ3GEYJ 391 V (390)	T	[EUR]
R319	7030003450	S.RES ERJ3GEYJ 122 V (1.2K)	T	[EUR-1]
R320	7030003340	S.RES ERJ3GEYJ 151 V (150)	T	[EUR]
R321	7030003200	S.RES ERJ3GEYJ 100 V (10)	T	[EUR-1]
R322	7030003340	S.RES ERJ3GEYJ 151 V (150)	T	[EUR]
R323	7030003200	S.RES ERJ3GEYJ 100 V (10)	T	[EUR-1]
R324	7030003430	S.RES ERJ3GEYJ 821 V (820)	T	48.1/105.9
R325	7030003520	S.RES ERJ3GEYJ 472 V (4.7K)	T	50.2/62.9
R326	7030003720	S.RES ERJ3GEYJ 224 V (220K)	T	52.5/63.7
R327	7030003480	S.RES ERJ3GEYJ 222 V (2.2K)	T	52.5/62.2
R328	7030003420	S.RES ERJ3GEYJ 681 V (680)	T	52.4/106.6
R329	7030003520	S.RES ERJ3GEYJ 472 V (4.7K)	T	54.8/106.8
R330	7030003450	S.RES ERJ3GEYJ 122 V (1.2K)	T	57.5/62.2
R331	7030003760	S.RES ERJ3GEYJ 474 V (470K)	T	52/74.4
R332	7030003520	S.RES ERJ3GEYJ 472 V (4.7K)	T	47.8/74.4
R333	7030003620	S.RES ERJ3GEYJ 333 V (33K)	T	56.6/74.5
R334	7030003400	S.RES ERJ3GEYJ 471 V (470)	T	57.1/65.1
R335	7030003380	S.RES ERJ3GEYJ 331 V (330)	T	52.9/76.6
R336	7030003530	S.RES ERJ3GEYJ 562 V (5.6K)	T	39/47
R337	7310005140	S.TRI RH03ADCJ3X (2.2K)	T	39/43.8
R338	7030003500	S.RES ERJ3GEYJ 332 V (3.3K)	T	39/40.2
R339	7520000120	POS PTFM04BC222Q2N34B0 (PTH9M04 BC)		
R340	7030003640	S.RES ERJ3GEYJ 473 V (47K)	T	56.2/96.4
R341	7310005110	S.TRI RH03ADC2X (470)	T	55.7/79.7
C101	4310000860	MYL 50 F2D 474J		
C102	4510007351	ELE 35 ME 1000 AX		

M.=Mounted side (T: Mounted on the Top side, B: Mounted on the Bottom side)  
S.=Surface mount

[REG-DC UNIT]

REF NO.	PARTS NO.	DESCRIPTION	M.	H/V LOCATION
C103	4310000860	MYL 50 F2D 474J		
C104	4310000860	MYL 50 F2D 474J		
C105	4510008451	ELE 35 ME 2200 AX		
C107	4340000320	S.MYL ECHU1H473JC9	T	119.3/188
C108	4340000320	S.MYL ECHU1H473JC9	T	123.2/202.5
C110	4340000330	S.MYL ECHU1H103J	T	116/188.9
C111	4340000330	S.MYL ECHU1H103J	T	126.3/201.7
C112	4510007351	ELE 35 ME 1000 AX		
C113	4510007351	ELE 35 ME 1000 AX		
C114	4510007351	ELE 35 ME 1000 AX		
C115	4340000340	S.MYL ECWU1103JX5	T	64.9/172.2
C116	4340000340	S.MYL ECWU1103JX5	T	88.4/172.2
C117	4310001210	MYL 250 MMB 473K		
C118	4510007351	ELE 35 ME 1000 AX		
C119	4510007351	ELE 35 ME 1000 AX		
C120	4510007351	ELE 35 ME 1000 AX		
C121	4560000150	CER RPEE12A105ZAQ1E04B (RPE210E105Z)		
C122	4560000150	CER RPEE12A105ZAQ1E04B (RPE210E105Z)		
C123	4510009490	ELE 35 ME 470 HWN [EUR-1] only		
C201	4340000340	S.MYL ECWU1103JX5	T	74.1/35.2
C202	4340000340	S.MYL ECWU1103JX5	T	78.3/40.4
C203	4340000340	S.MYL ECWU1103JX5	T	85.5/40.4
C204	4510009180	ELE 25 ME 2700 AX		
C205	4510009180	ELE 25 ME 2700 AX		
C206	4510009180	ELE 25 ME 2700 AX		
C207	4340000330	S.MYL ECHU1H103J	T	48.4/12.9
C208	4340000330	S.MYL ECHU1H103J	T	53.8/21.8
C209	4510009180	ELE 25 ME 2700 AX		
C210	4510009180	ELE 25 ME 2700 AX		
C211	4510009180	ELE 25 ME 2700 AX		
C212	4340000350	S.MYL ECWU1C474JC9	T	27.6/22.4
C213	4340000350	S.MYL ECWU1C474JC9	T	8.5/34.4
C301	4340000360	S.MYL ECWU1H104JC9	T	35.5/208.6
C302	4340000360	S.MYL ECWU1H104JC9	T	7.5/201.5
C303	4510007180	ELE 50 ME 47 CZ		
C304	4340000330	S.MYL ECHU1H103J	T	20.3/194.8
C305	4340000330	S.MYL ECHU1H103J	T	16.5/194.7
C306	4340000250	S.MYL ECHU 1C 104JX5	T	13.4/194.7
C307	4510008970	S.ELE EEEHB1C100R	T	12.4/212.9
C308	4340000330	S.MYL ECHU1H103J	T	55.7/118.3
C401	4340000250	S.MYL ECHU 1C 104JX5	T	52/59.7
C402	4340000380	S.MYL ECHU1C474JC9	T	48.6/77
C403	4510009330	S.ELE EEEHA1E470WP	T	47.4/69.1
C404	4510008970	S.ELE EEEHB1C100R	T	55.2/102.9
C405	4510009290	S.ELE EEEHB1H1R0R	T	43.4/44
C407	4340000250	S.MYL ECHU 1C 104JX5	T	54/91.3
RL101	6330001830	REL ALF1P12		
RL102	6330001830	REL ALF1P12		
RL103	6330001830	REL ALF1P12 [EUR-1] only		
J101	6510004981	CON RTB-1.5-4F(LF)		
F101	5210000061	FUS FGB 5A PBF (FGB0 125V)		
F102	5220000230	HOL S-N5054 #01		
F103	5220000230	HOL S-N5054 #01		
T101	5910001040	TRA TP-75 (24V) [EUR]		
	5910001030	TRA TP-74 (12V) [EUR-1]		
EP101	6910010910	TER PB-3-S		
EP102	6910010910	TER PB-3-S		
EP104	6910018630	E.O 4PB-12		
EP105	6910010910	TER PB-3-S		
EP106	6910010910	TER PB-3-S		
EP107	6910018630	E.O 4PB-12		
EP201	6910011330	TER OT-009 M3		
EP202	6910011330	TER OT-009 M3		
EP205	6910011330	TER OT-009 M3		
EP206	6910010910	TER PB-3-S		
EP207	6910011330	TER OT-009 M3		
EP418	9029702901	TUB 0.7 L=8MM		

[DSP UNIT]

REF NO.	PARTS NO.	DESCRIPTION	M.	H/V LOCATION
IC1	1130010011	S.IC TC7WU04FU(TE12L,F)	T	54.6/17
IC3	1130010540	S.IC SN74AHC74PWR	B	51.9/12.2
IC4	1130010540	S.IC SN74AHC74PWR	B	56.1/22.1
IC51	1130010011	S.IC TC7WU04FU(TE12L,F)	T	31.7/15.1
IC101	1130010520	S.IC SN74HCT244APWR	T	18.9/21.8
IC102	1110004770	S.IC BU9480F-E2	B	68.7/4.5
IC152	1180002321	S.REG TK11218CMCL-G	T	77.8/46.9
IC161	1180002020	S.REG BA003FP-E2	B	64/43.1
IC171	1180002271	S.REG TK11250CMCL-G	T	78.4/3.6
IC201	1130012702	S.IC AT49LV1024A-45VL	B	41.4/37.8
IC202	1130008041	S.IC TC7SH04FU(TE85L,JF)	B	51.1/40.5
IC203	1130008811	S.IC TC7SH32FU(TE85L,JF)	B	52/30.3
IC301	1140010330	S.IC TMS320VC33PGEA120	T	41.1/32.9
IC401	1130010550	S.IC SN74AHC595PWR	T	18.9/31.7
IC403	1130010530	S.IC SN74AHC74PWR	B	18.8/42.2
IC404	1130010530	S.IC SN74AHC74PWR	B	18.8/31.6
IC405	1130004670	S.IC BU4021BF-E2	B	19.1/22.9
IC406	1130010540	S.IC SN74AHC74PWR	T	18.9/11.8
IC501	1190001611	S.IC AK4528VFP-E2/P	T	64.5/25.6
IC601	1110005420	S.IC BA15532F-E2	B	74.7/42
IC651	1110005420	S.IC BA15532F-E2	B	75/31.1
IC701	1110001901	S.IC UPC4570G2-E1-A	B	72.3/15.7
IC801	1130010560	S.IC SN74AHC244PWR	B	17.9/10.3
Q201	15900001660	S.TRA XP4312(TX)	B	41.3/31.2
Q301	1590000430	S.TRA DTC144EUA T106	T	10.1/44.9
Q302	1590000430	S.TRA DTC144EUA T106	T	10.1/47.4
D301	1750000370	S.DIO DA221 TL	T	27.5/41.8
D302	1750000370	S.DIO DA221 TL	T	28.1/45.3
D303	1750000370	S.DIO DA221 TL	T	27.6/47.4
D304	1750000370	S.DIO DA221 TL	B	34.5/22.5
D901	1790000970	S.DIO MA729(TX)	T	10.2/42.8
X1	6050009860	S.XTA CR-566 SMD-49 12.288 MHz	T	50.4/11.4
X51	6050011270	S.XTA CR-709 SMD-49 60.000 MHz	T	32.2/9.3
L1	6200003281	S.COI NLV25T-2R2J	T	54.4/21.3
L2	6200003281	S.COI NLV25T-2R2J	B	48.1/16.7
L3	6200003281	S.COI NLV25T-2R2J	B	61.2/18.6
L51	6200003281	S.COI NLV25T-2R2J	T	36.1/14.5
L52	6200001981	S.COI NLV25T-1R0J	T	27.4/15.2
L101	6200003281	S.COI NLV25T-2R2J	T	17.1/16.2
L102	6200003281	S.COI NLV25T-2R2J	T	66.9/7.4
L301	6200003281	S.COI NLV25T-2R2J	B	56.4/46.9
L302	6200009840	S.COI LQH32CN2R2M23L	B	57.5/39.7
L401	6200003281	S.COI NLV25T-2R2J	T	13.7/34.7
L403	6200003281	S.COI NLV25T-2R2J	B	23.8/46.4
L404	6200003281	S.COI NLV25T-2R2J	B	23.8/35.7
L405	6200003281	S.COI NLV25T-2R2J	B	12.6/18.8
L406	6200003281	S.COI NLV25T-2R2J	T	13.3/8.7
L501	6200003281	S.COI NLV25T-2R2J	T	60.8/19
L502	6200003281	S.COI NLV25T-2R2J	T	69.8/7.8
L601	6200002041	S.COI NLV25T-101J	T	79.2/37.5
L651	6200002041	S.COI NLV25T-101J	T	78.6/27
L701	6200002041	S.COI NLV25T-101J	T	77.9/16.6
L801	6200003281	S.COI NLV25T-2R2J	B	12.2/7.3
R1	7030003800	S.RES ERJ3GEYJ 105 V (1M)	T	50.5/14.7
R2	7030003440	S.RES ERJ3GEYJ 102 V (1K)	T	55.7/14.7
R3	7030003640	S.RES ERJ3GEYJ 473 V (47K)	T	58.4/20.4
R4	7030003860	S.RES ERJ3GE JPW V	T	53/19.4
R5	7030008240	S.RES ERJ12Y0R00U	B	59.8/30.1
R6	7030003860	S.RES ERJ3GE JPW V	B	58.8/16.1
R7	7030008240	S.RES ERJ12Y0R00U	B	58.8/4.5
R8	7030003860	S.RES ERJ3GE JPW V	T	57.4/2.4
R51	7030003800	S.RES ERJ3GEYJ 105 V (1M)	T	30.5/12.6
R52	7030003320	S.RES ERJ3GEYJ 101 V (100)	T	36.5/12.6
R151	7030007240	S.RES ERJ12YJ680U (68)	B	82.3/44.1
R152	7030008240	S.RES ERJ12Y0R00U	B	77.3/5
R153	7030003860	S.RES ERJ3GE JPW V	T	84.8/43.7
R161	7030008190	S.RES ERJ12YJ330U (33)	T	66.1/45.6
R162	7030007510	S.RES ERJ12YJ270U (27)	T	66.1/41.9
R171	7030007180	S.RES ERJ12YJ150U (15)	B	83.4/6
R172	7030008240	S.RES ERJ12Y0R00U	B	78.4/9.9
R201	7030003640	S.RES ERJ3GEYJ 473 V (47K)	B	37.8/31.4
R202	7030003860	S.RES ERJ3GE JPW V	B	37.5/43.9
R203	7030003860	S.RES ERJ3GE JPW V	B	53.4/45.1
R204	7030003860	S.RES ERJ3GE JPW V	B	58.2/26.5
R302	7030003860	S.RES ERJ3GE JPW V	B	36.9/26.8
R303	7030003480	S.RES ERJ3GEYJ 222 V (2.2K)	B	48.2/22.7
R304	7030003480	S.RES ERJ3GEYJ 222 V (2.2K)	B	46.9/22.7
R305	7030003560	S.RES ERJ3GEYJ 103 V (10K)	B	47.1/26.2
R306	7030003560	S.RES ERJ3GEYJ 103 V (10K)	B	45.6/22.7
R307	7030003560	S.RES ERJ3GEYJ 103 V (10K)	B	42.7/22.7
R308	7030003560	S.RES ERJ3GEYJ 103 V (10K)	B	41.4/22.7
R309	7030003560	S.RES ERJ3GEYJ 103 V (10K)	B	40.1/22.7
R310	7030003560	S.RES ERJ3GEYJ 103 V (10K)	B	38.8/22.7
R311	7030003560	S.RES ERJ3GEYJ 103 V (10K)	B	38.9/26.8
R312	7030003560	S.RES ERJ3GEYJ 103 V (10K)	B	37.5/22.7
R313	7030003560	S.RES ERJ3GEYJ 103 V (10K)	B	36.2/22.7
R317	7030003560	S.RES ERJ3GEYJ 103 V (10K)	T	46.1/48.1
R318	7030003560	S.RES ERJ3GEYJ 103 V (10K)	T	43.6/46.2
R320	7030003520	S.RES ERJ3GEYJ 472 V (4.7K)	B	31/30.3
R321	7030003520	S.RES ERJ3GEYJ 472 V (4.7K)	B	31/31.6
R322	7030003280	S.RES ERJ3GEYJ 470 V (47)	B	13.8/40.9
R323	7030003560	S.RES ERJ3GEYJ 103 V (10K)	B	28.2/45.4
R324	7030003560	S.RES ERJ3GEYJ 103 V (10K)	B	28.2/46.7
R325	7030003560	S.RES ERJ3GEYJ 103 V (10K)	T	54.8/43.1

M.=Mounted side (T: Mounted on the Top side, B: Mounted on the Bottom side) S.=Surface mount





# BOARD LAYOUTS

The combination of this side and the bottom side shows the board layout in the same configuration as the actual P.C.Board.

• MAIN UNIT  
(TOP VIEW)

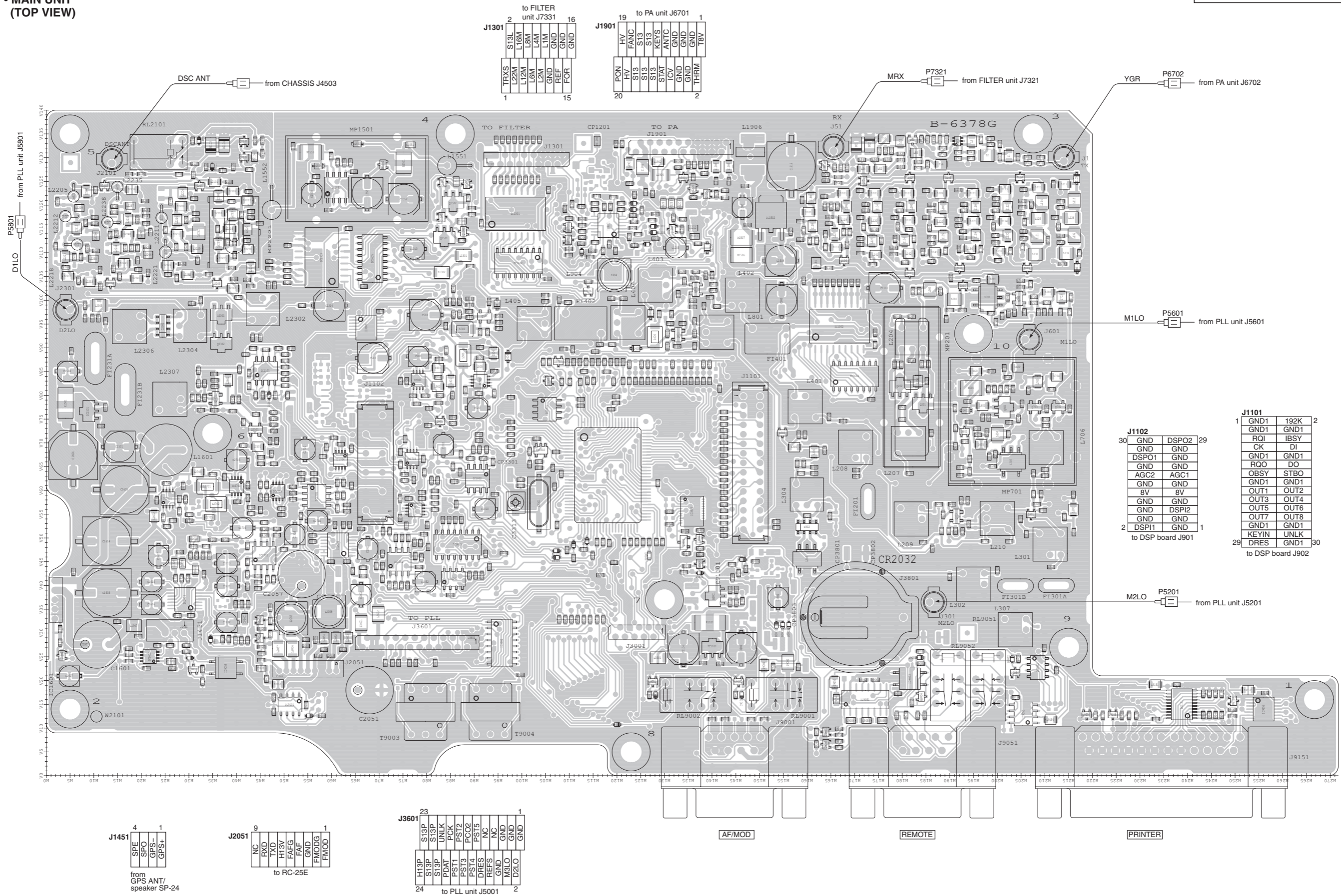

to FILTER unit J7331

16	GND
15	GND
14	FOR
13	REF
12	GND
11	L1M
10	L2M
9	L3M
8	L4M
7	L5M
6	L6M
5	L7M
4	L8M
3	L9M
2	L10M
1	TRXS

to PA unit J6701

1	T&V
2	GND
3	GND
4	GND
5	THR
6	GND
7	GND
8	GND
9	ICV
10	ANTC
11	KEYS
12	S13
13	S13
14	S13
15	FANC
16	HV
17	PON
18	GND
19	GND

J1102

30	GND	DSPO2	29
29	GND	GND	
28	DSPO1	GND	
27	GND	GND	
26	AGC2	AGC1	
25	GND	GND	
24	8V	8V	
23	GND	GND	
22	GND	DSPI2	
21	GND	GND	
20	DSPI1	GND	1

to DSP board J901

J1101

1	GND1	192K	2
2	GND1	GND1	
3	RQ1	IBSY	
4	CK	DI	
5	GND1	GND1	
6	RQ0	DO	
7	OBSY	STBO	
8	GND1	GND1	
9	OUT1	OUT2	
10	OUT3	OUT4	
11	OUT5	OUT6	
12	OUT7	OUT8	
13	GND1	GND1	
14	KEYIN	UNLK	
15	DRES	GND1	30

to DSP board J902

J1451

4	SPE	1
3	SPO	
2	GPS-	
1	GPS+	

from GPS ANT/  
speaker SP-24

J2051

9	NC	1
8	RXD	
7	TXD	
6	H13V	
5	FAFG	
4	FAF	
3	GND	
2	FMODG	
1	FMOD	

to RC-25E

J3601

23	H13P	1
22	S13P	
21	S13P	
20	S13P	
19	UNLK	
18	PK	
17	PS11	
16	PS12	
15	PS13	
14	PS14	
13	PS15	
12	DRES	
11	REFS	
10	NC	
9	NC	
8	GND	
7	GND	
6	GND	
5	M1LO	
4	D2LO	
3	GND	
2	GND	
1	GND	

to PLL unit J5001

[AF/MOD]

[REMOTE]

[PRINTER]

• MAIN UNIT  
(BOTTOM VIEW)

The combination of this side and the bottom side shows  
the board layout in the same configuration as the actual  
P.C.Board.

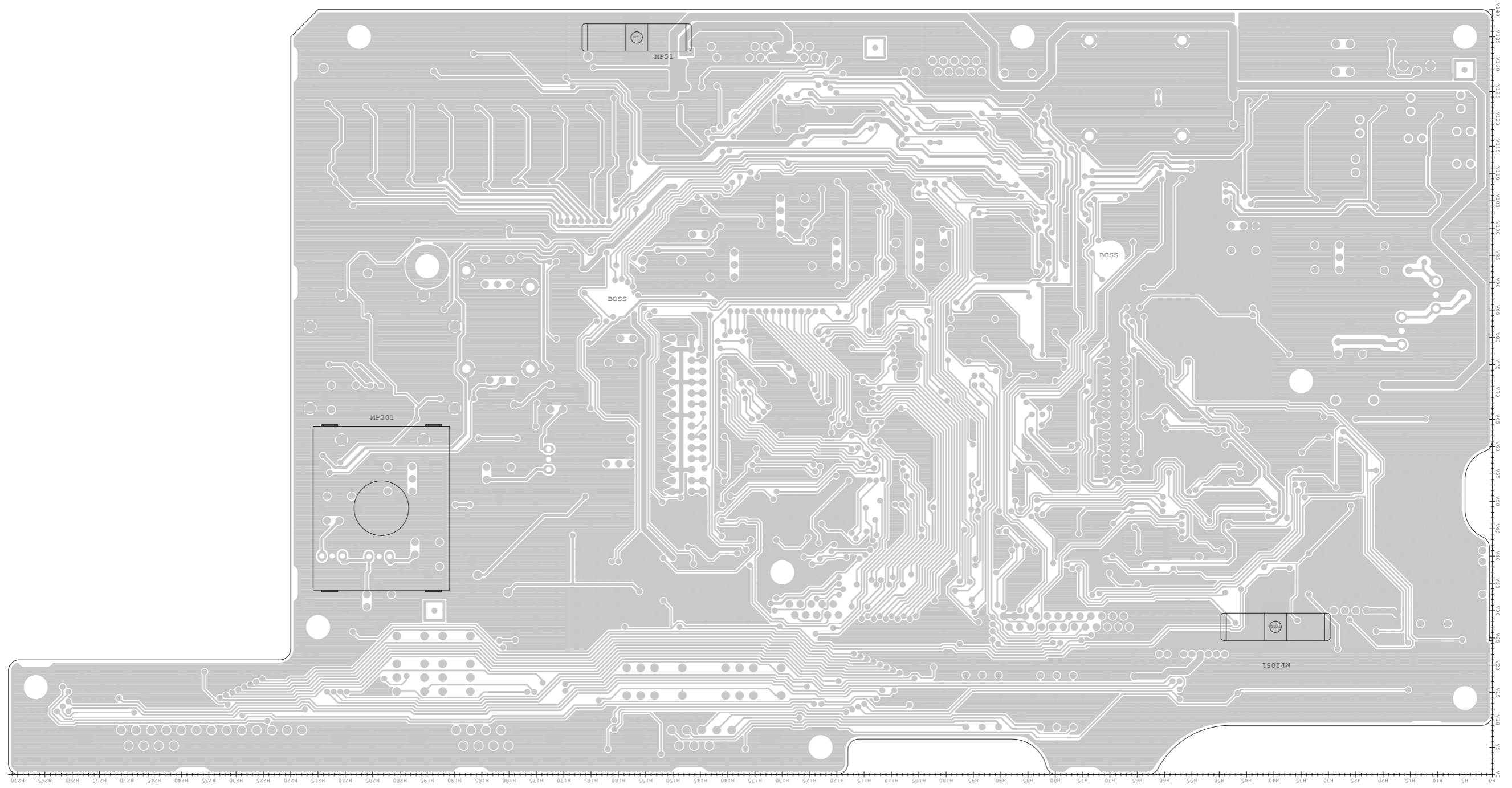

• PLL UNIT  
(TOP VIEW)

The combination of this side and the bottom side shows the board layout in the same configuration as the actual P.C.Board.

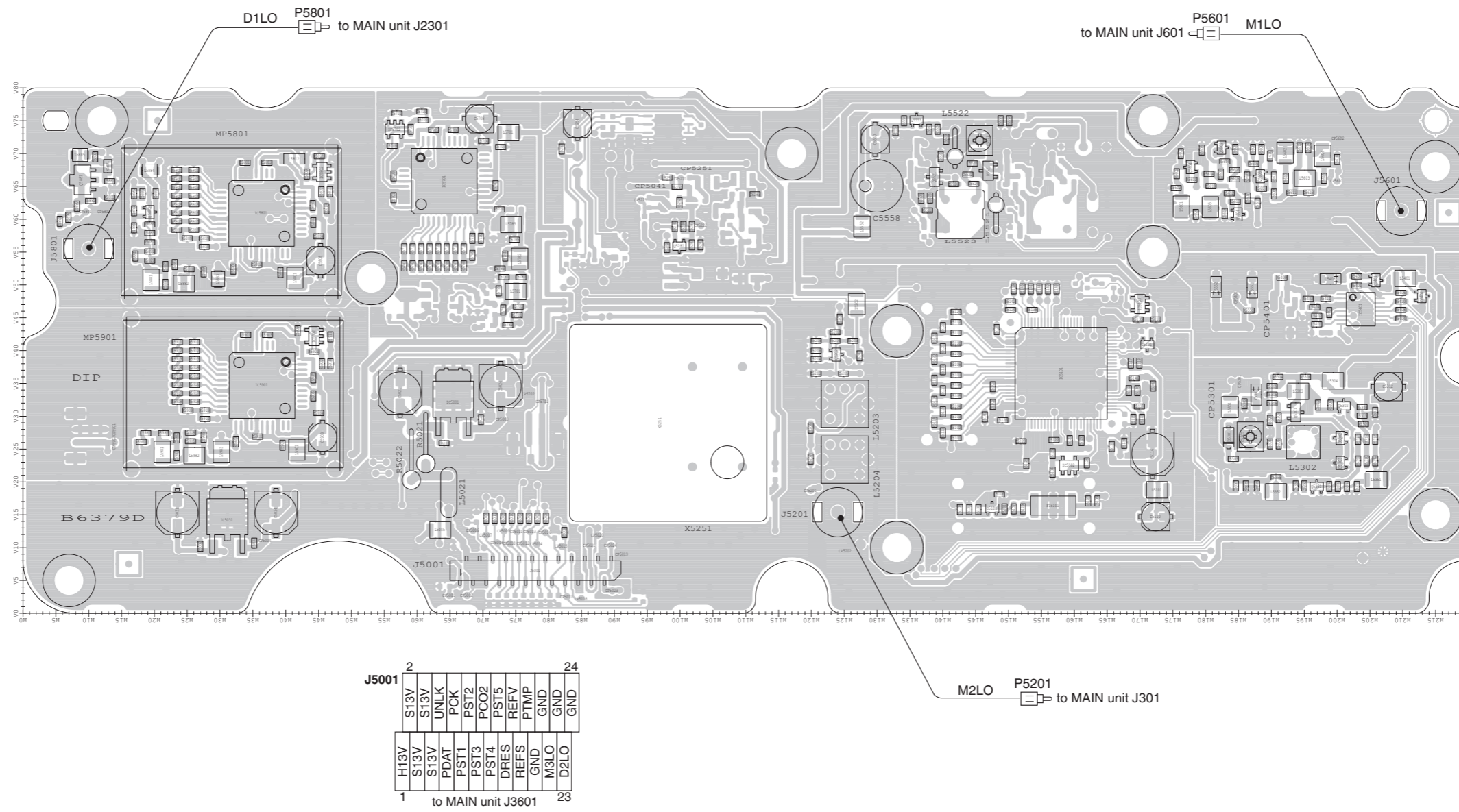

• PLL UNIT  
(BOTTOM VIEW)

The combination of this side and the bottom side shows the board layout in the same configuration as the actual P.C.Board.

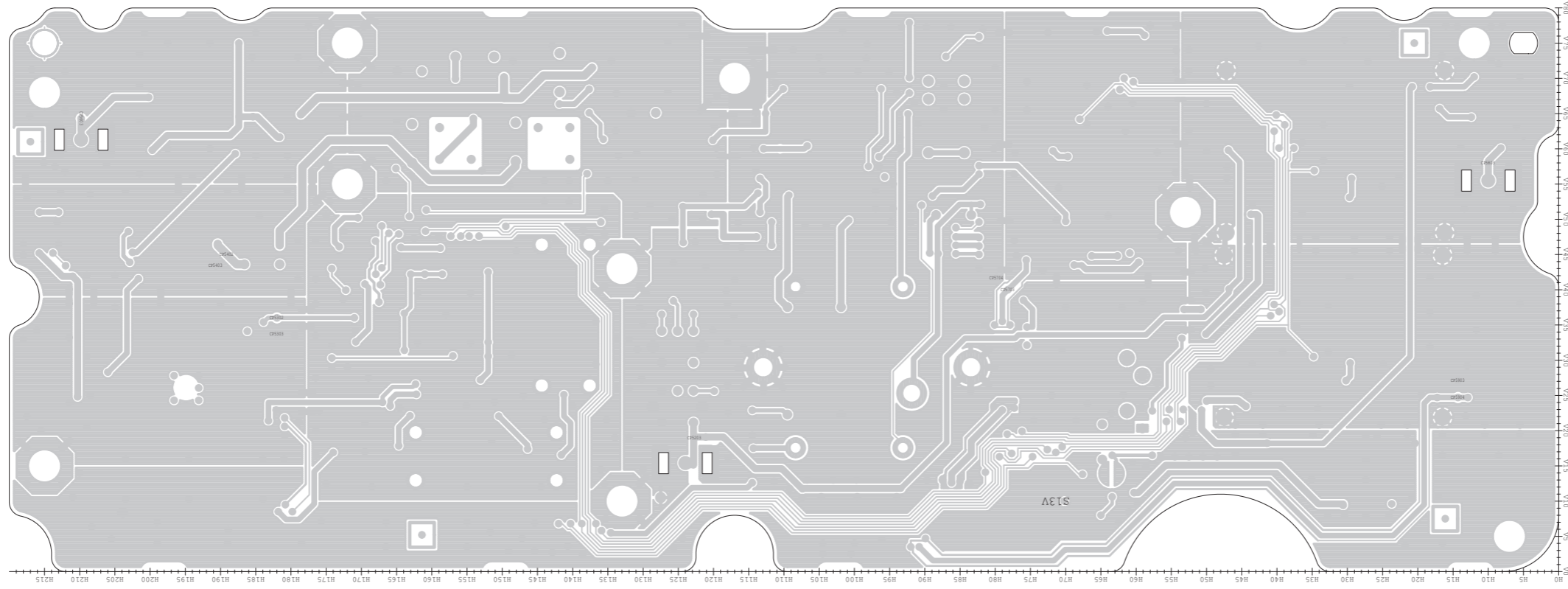

• REG-DC UNIT  
(TOP VIEW)

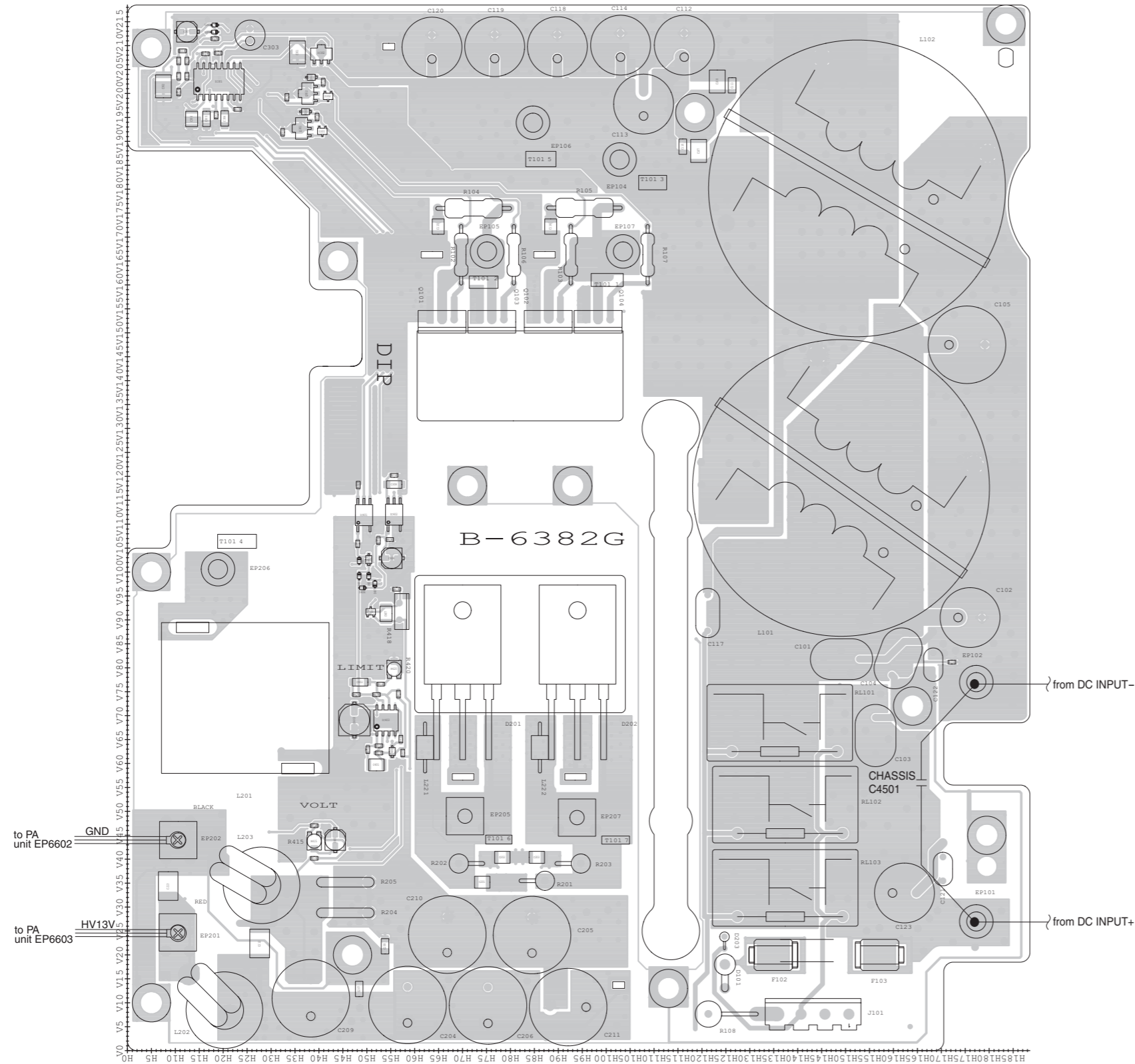

The combination of this side and the bottom side shows the board layout in the same configuration as the actual P.C.Board.

• DRIVER BOARD  
(TOP VIEW)

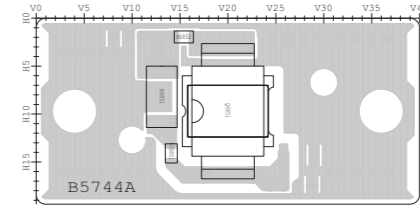

• VARISTOR-1 BOARD  
(TOP VIEW)

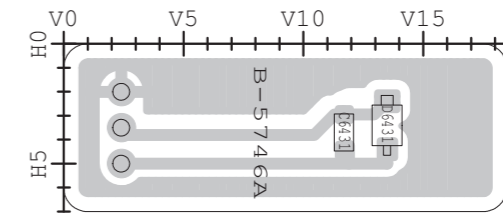

• VARISTOR-2 BOARD  
(TOP VIEW)

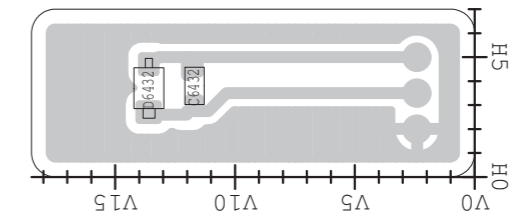

The combination of this side and the bottom side shows the board layout in the same configuration as the actual P.C.Board.

• REG-DC UNIT  
(BOTTOM VIEW)

• DRIVER BOARD  
(BOTTOM VIEW)

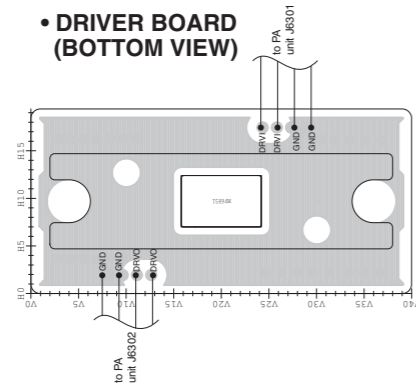

• VARISTOR-1 BOARD  
(BOTTOM VIEW)

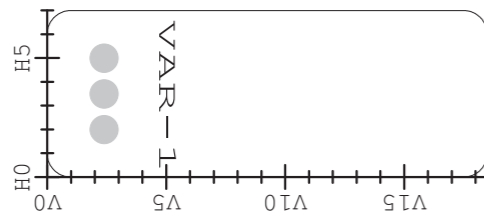

• VARISTOR-2 BOARD  
(BOTTOM VIEW)

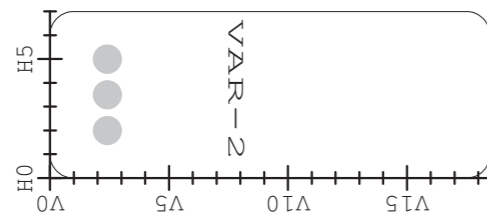

# VOLTAGE DIAGRAM

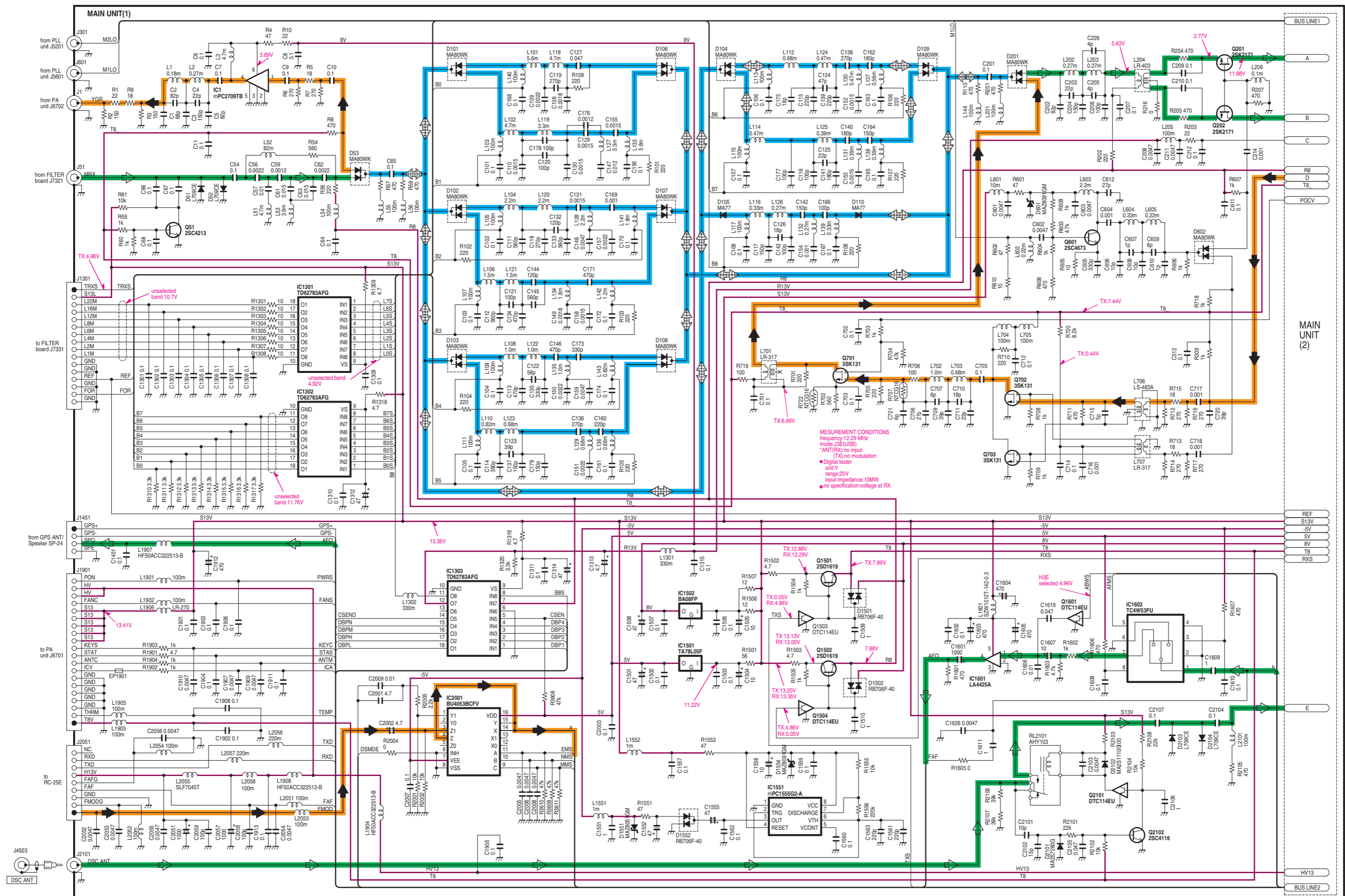

\*; Refer to "PARTS LIST."



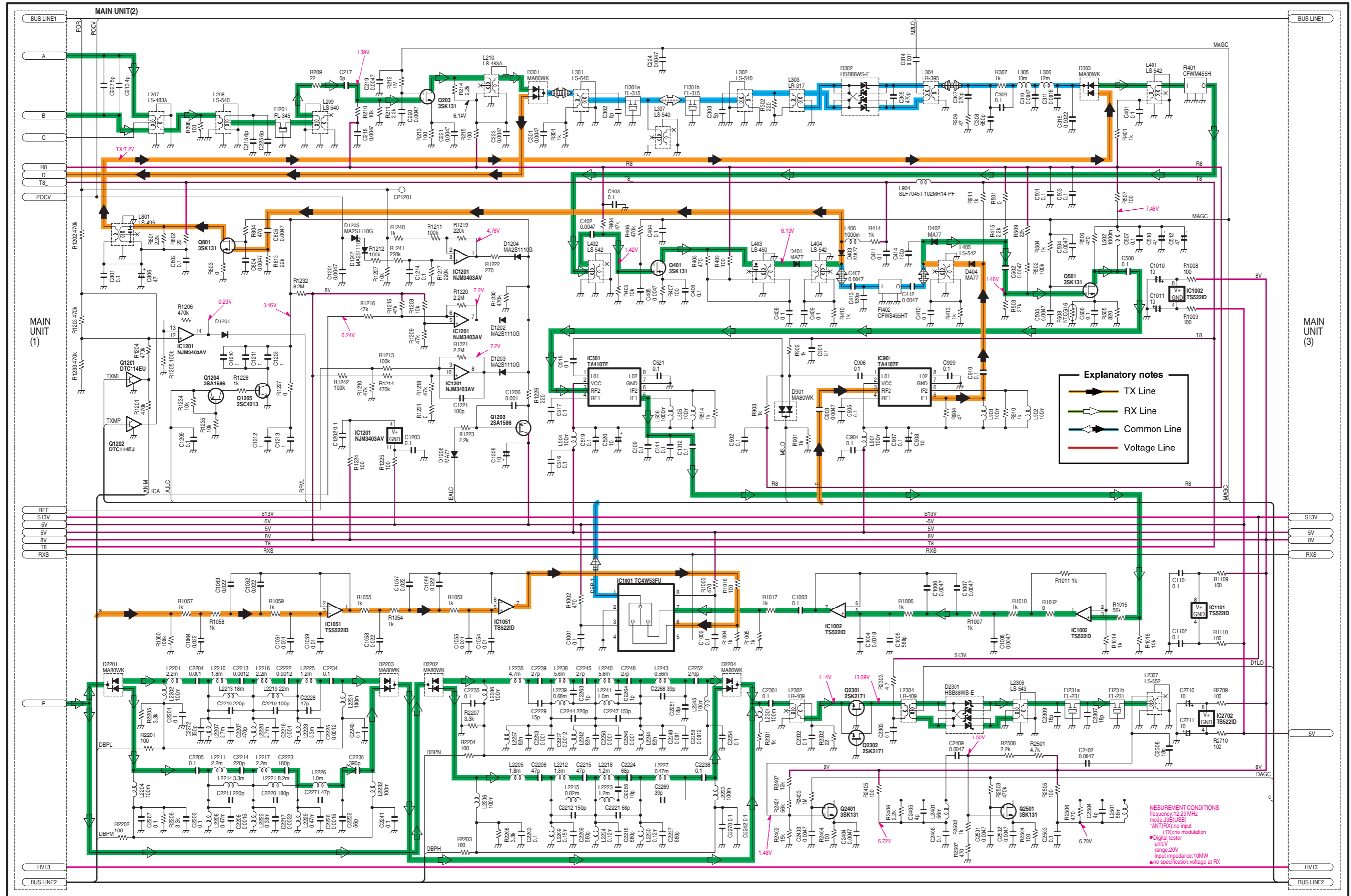

\*; Refer to "PARTS LIST."

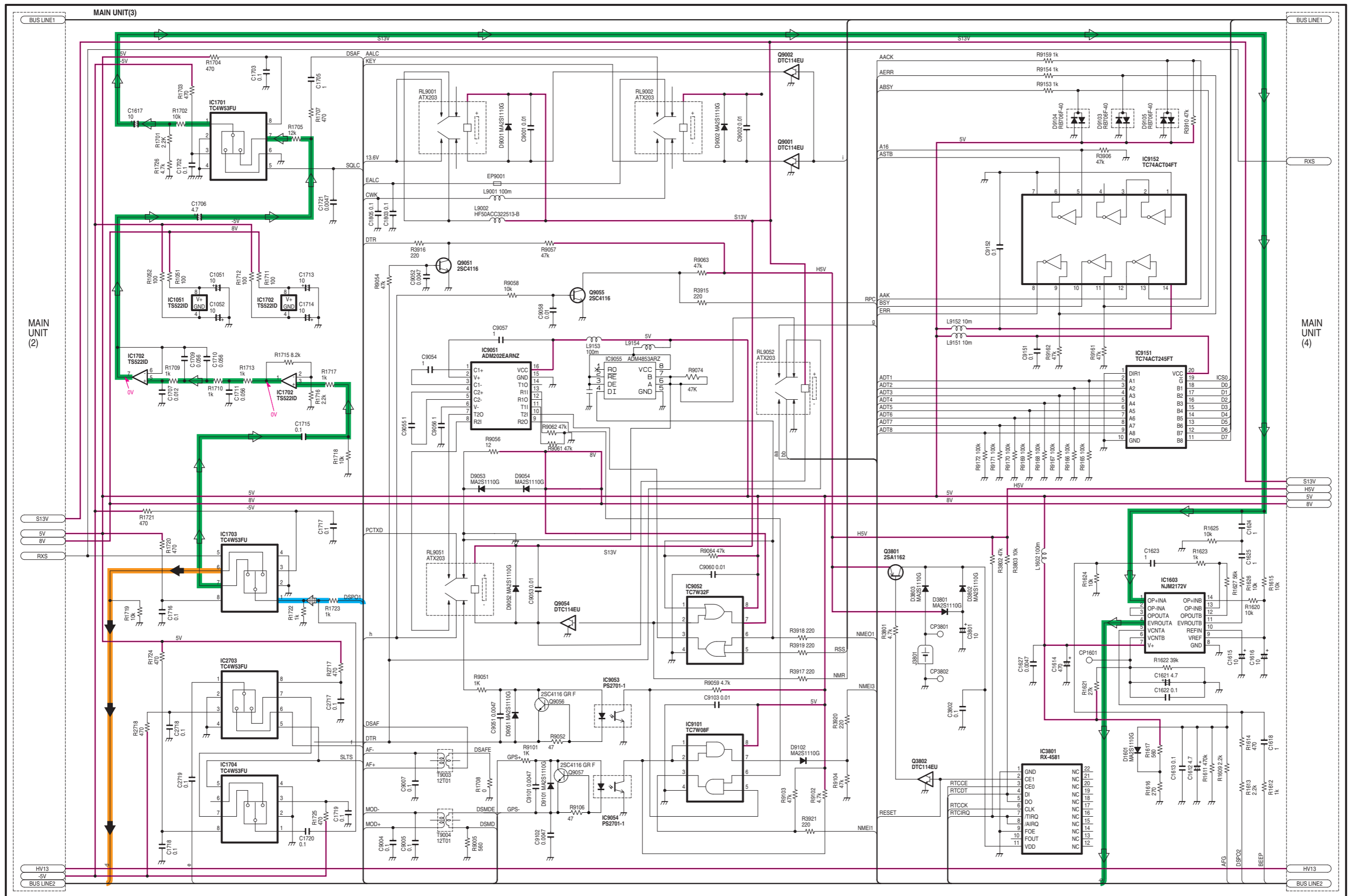

\*; Refer to "PARTS LIST."

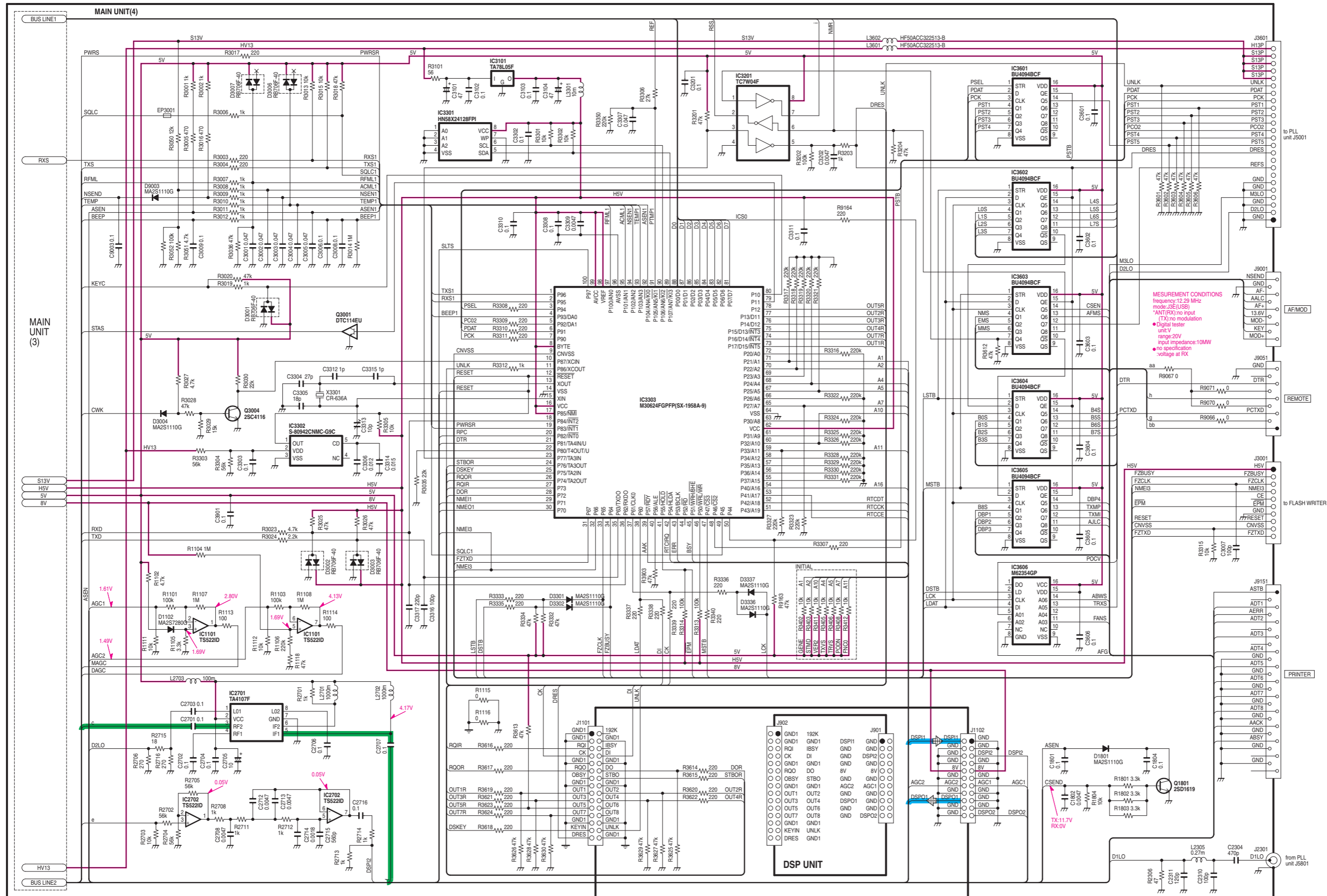

\*, Refer to "PARTS LIST."

PA UNIT

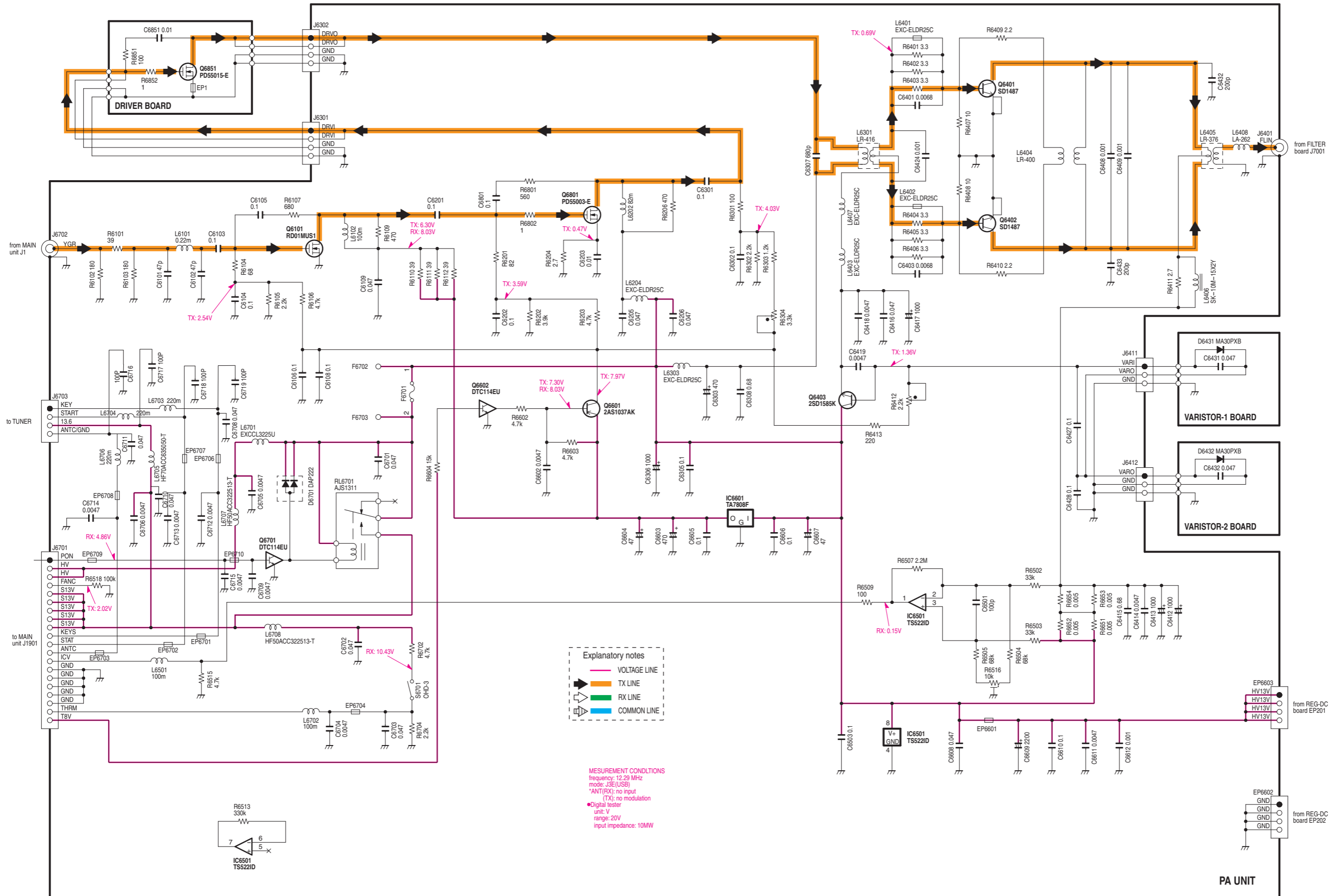

\*; Refer to "PARTS LIST."

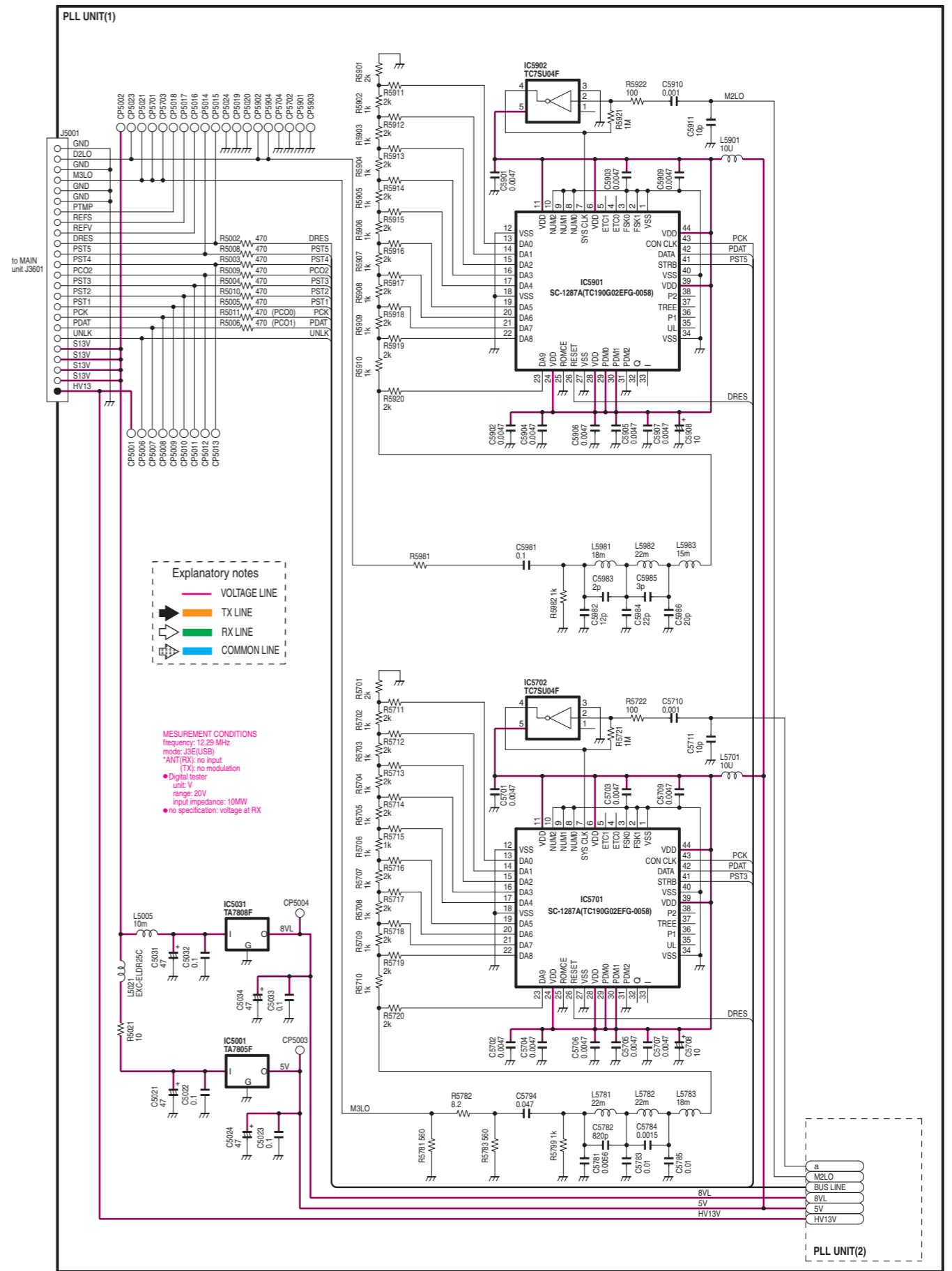
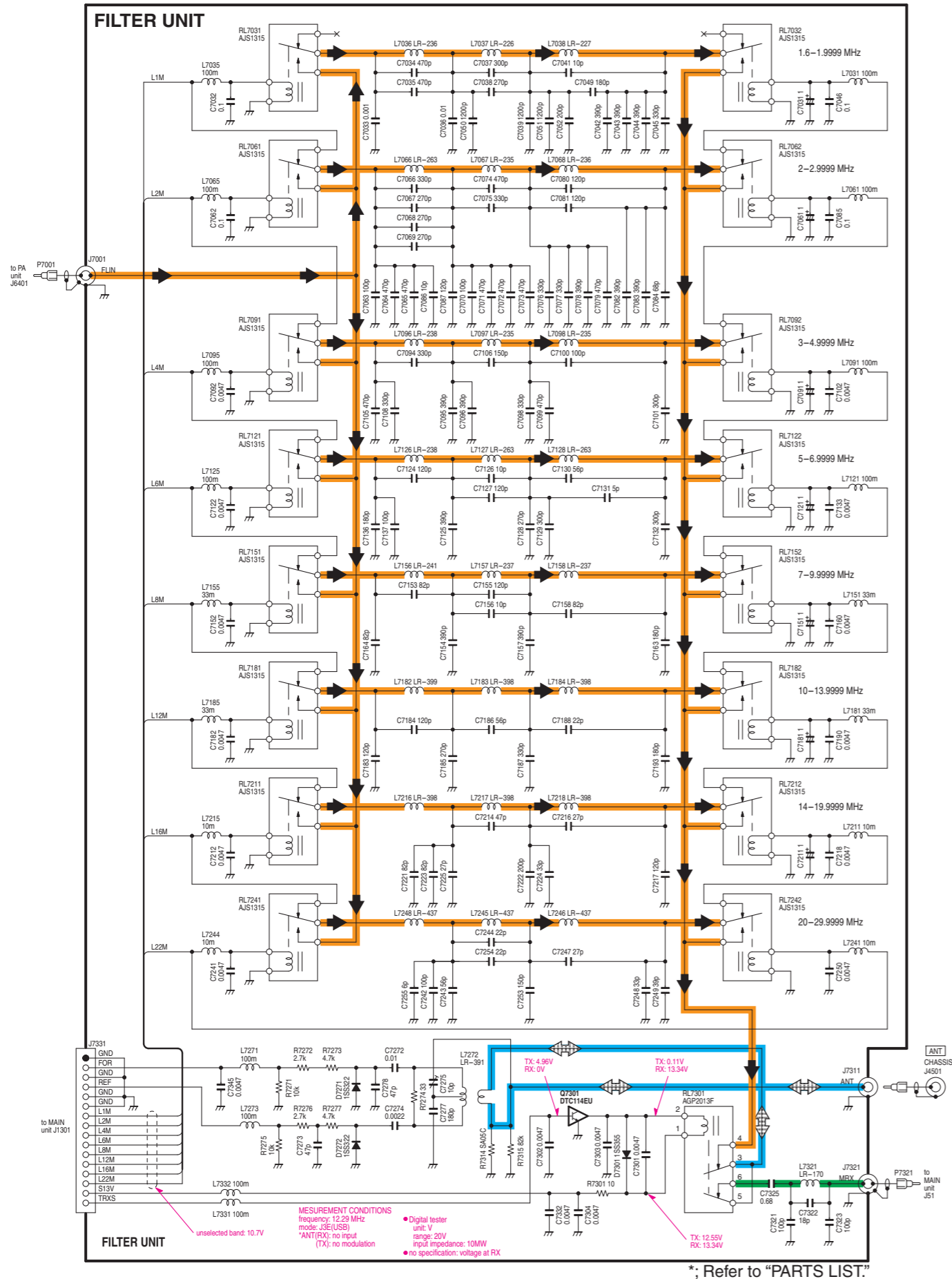

\*, Refer to "PARTS LIST."

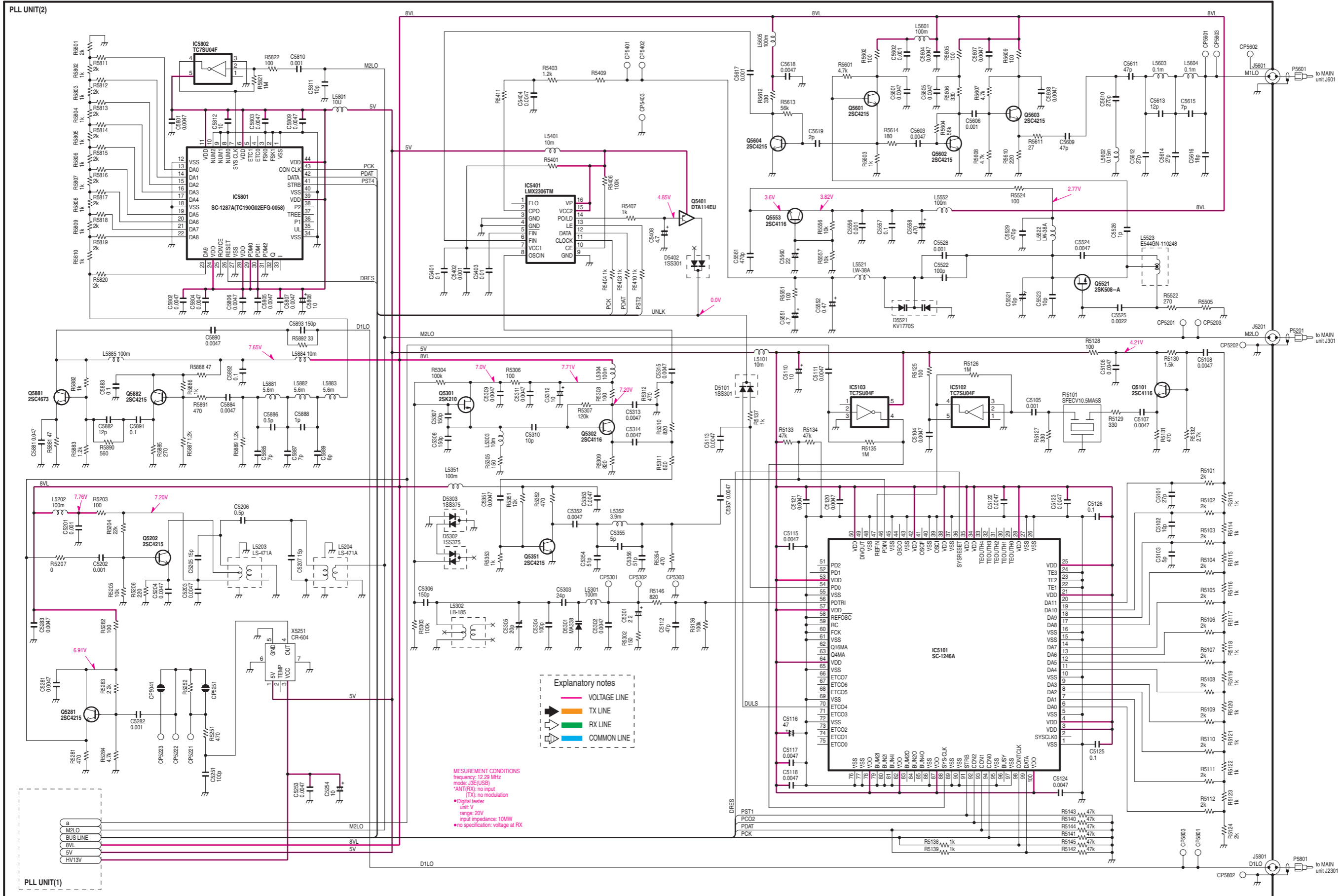

\*; Refer to "PARTS LIST."

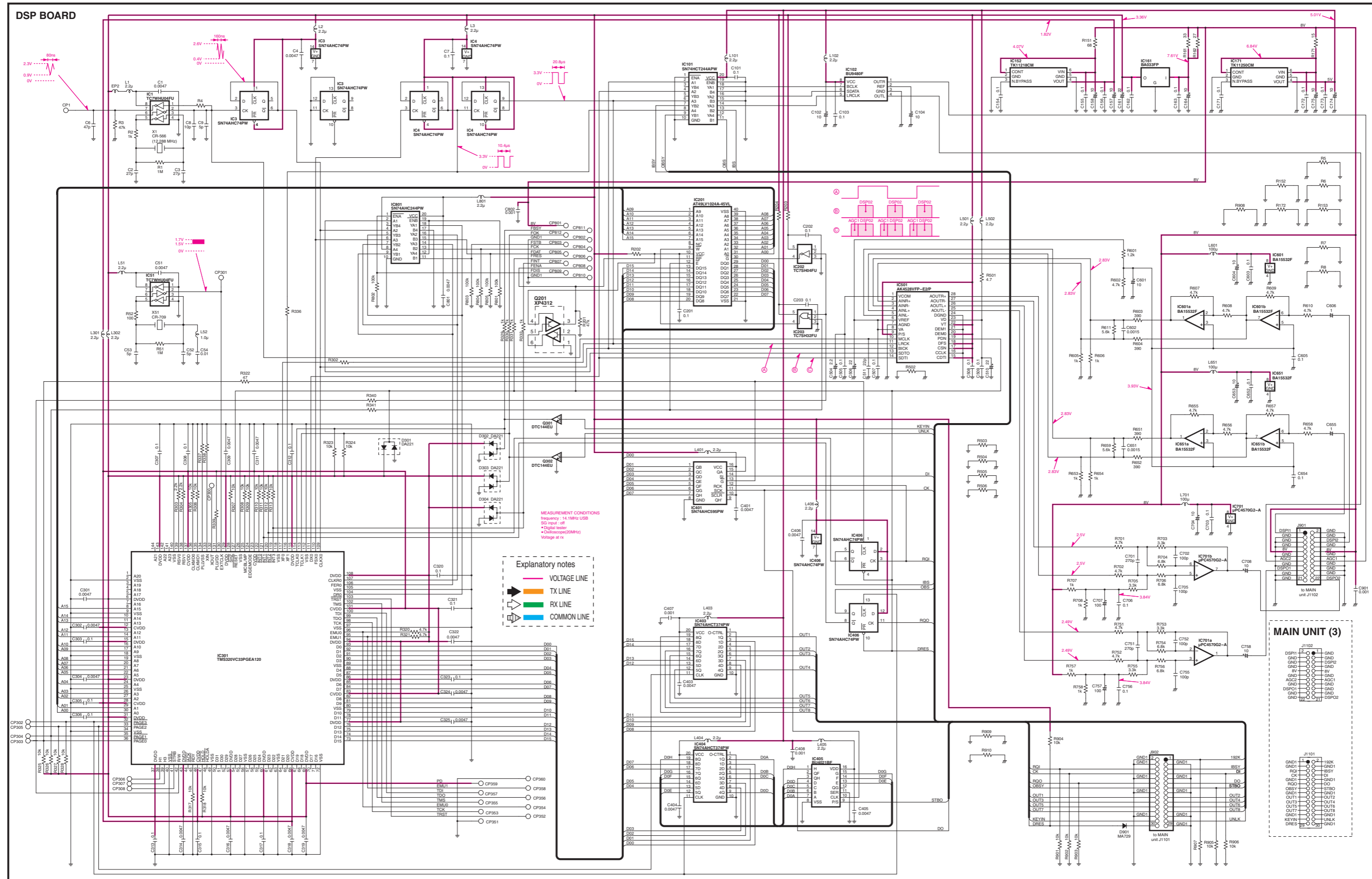

\*; Refer to "PARTS LIST".

# REG-DC UNIT

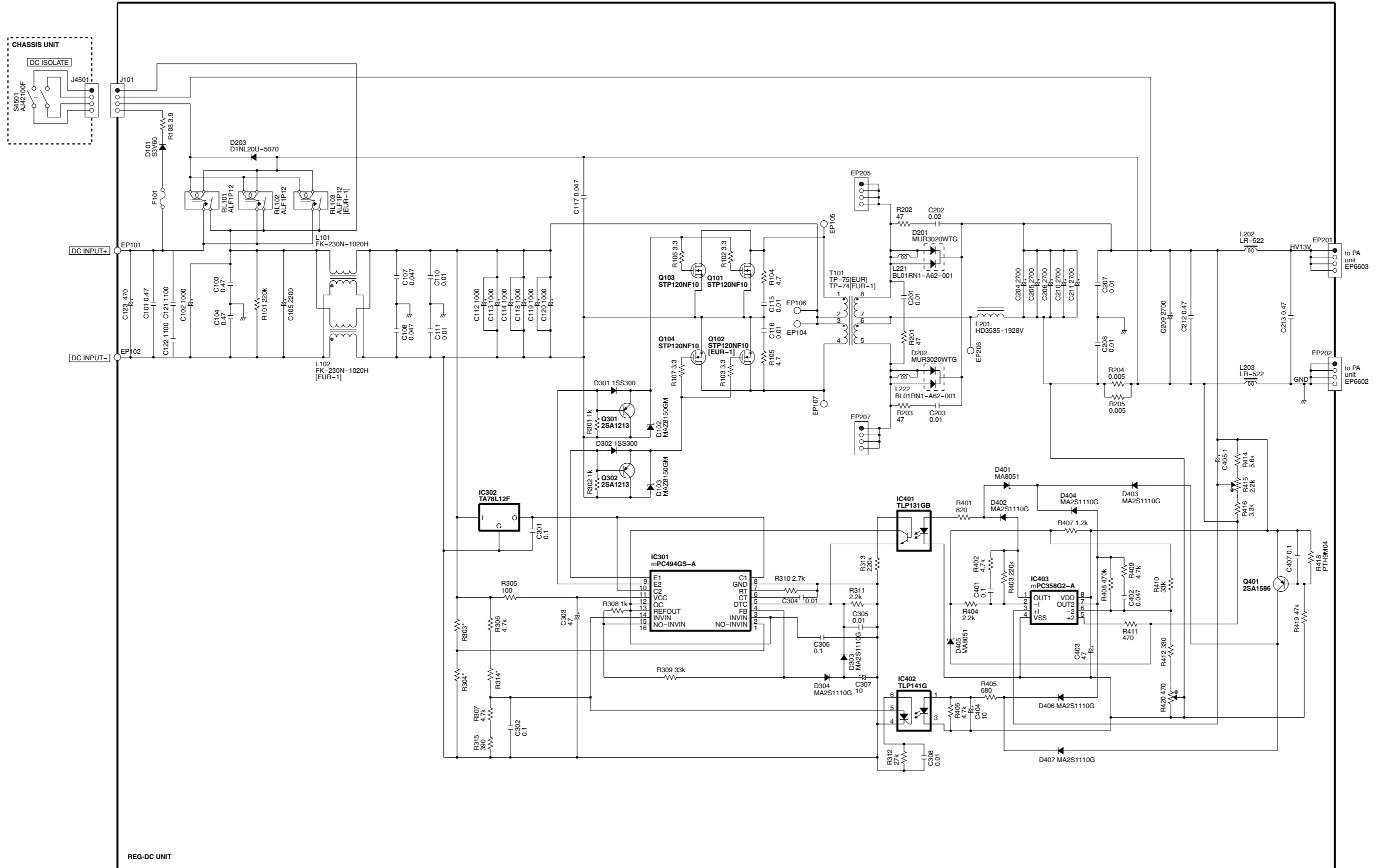

\*; Refer to "PARTS LIST."





# SERVICE MANUAL

MF/HF MARINE TRANSCEIVER

**IC-M801E**

HF AUTOMATIC ANTENNA TUNER

**AT-141**

---

---

---

---

---

S-14232HZ-C1

Mar. 2006

Icom Inc.

---

---

## INTRODUCTION

---

This service manual describes the latest service information for the **IC-M801E** MF/HF MARINE TRANSCEIVER and **AT-141** HF AUTOMATIC ANTENNA TUNER at the time of publication.

MODEL	VERSION	INPUT VOLTAGE
IC-M801E	EUR	24 V
	EUR-1	12 V

To upgrade quality, all electrical or mechanical parts and internal circuits are subject to change without notice or obligation.

---

## PRECAUTIONS

---

**Never** connect the transceiver to an AC outlet or to a DC power supply that uses more than 15.6 V or 31.2 V DC (depending on the transceiver version). Such a connection could cause a fire or electric hazard.

**DO NOT** expose the transceiver to rain, snow or any liquids.

**DO NOT** reverse the polarities of the power supply when connecting the transceiver.

**DO NOT** apply an RF signal of more than 20 dBm (100 mW) to the antenna connector. This could damage the transceiver's front end.



---

## ORDERING PARTS

---

Be sure to include the following four points when ordering replacement parts:

1. 10-digit Icom parts number
2. Component name and informations
3. Equipment model name and unit name
4. Quantity required

<SAMPLE ORDER>

1110006870 S.IC    μPC2709TB    IC-M801E    Main unit    5 pieces  
8810009650 Screw    FH BT M3×8 NI-ZU    IC-M801E    Chassis    10 pieces

Addresses are provided on the inside back cover for your convenience.

---

## REPAIR NOTES

---

1. Make sure the problem is internal before disassembling the transceiver.
2. **DO NOT** open the transceiver until the transceiver is disconnected from its power source.
3. **DO NOT** force any of the variable components. Turn them slowly and smoothly.
4. **DO NOT** short any circuits or electronic parts. An insulated turning tool **MUST** be used for all adjustments.
5. **DO NOT** keep power ON for a long time when the transceiver is defective.
6. **DO NOT** transmit power into a signal generator or a sweep generator.
7. **ALWAYS** connect a 50 dB to 60 dB attenuator between the transceiver and a deviation meter or spectrum analyzer when using such test equipment.
8. **READ** the instructions of test equipment thoroughly before connecting equipment to the transceiver.

• SYSTEM CONNECTION

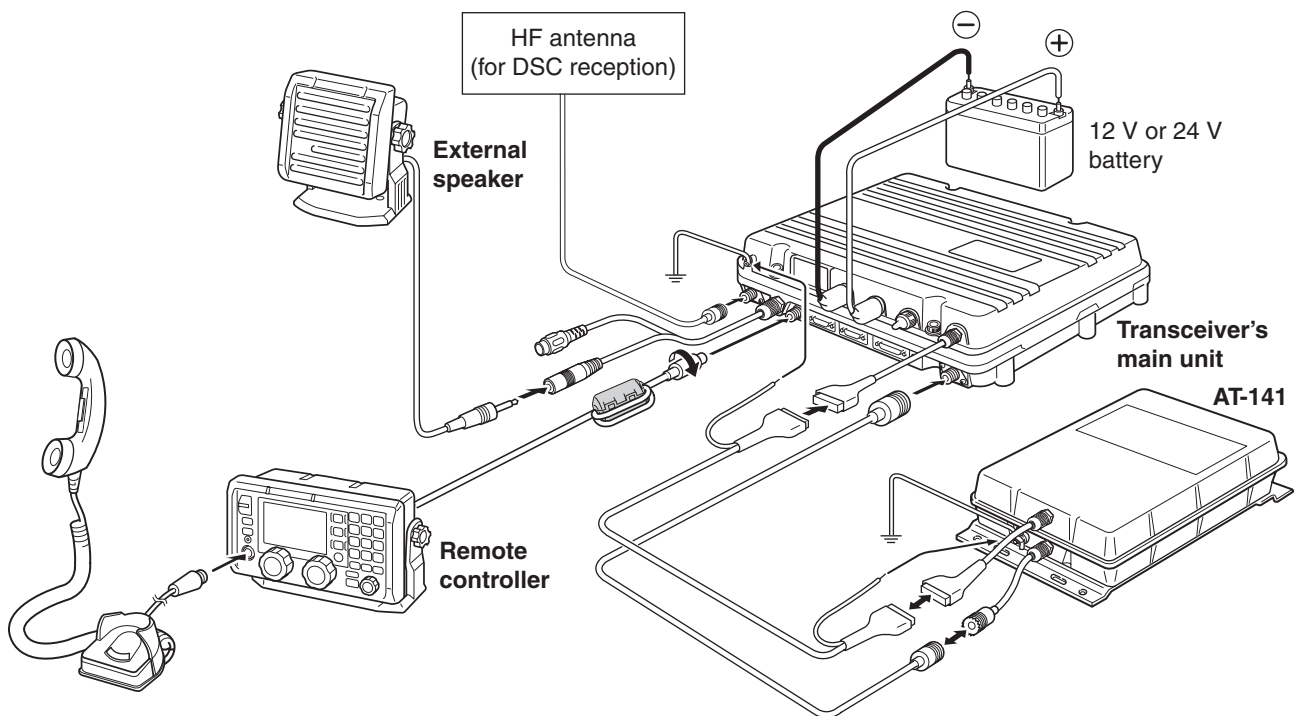

---

## TABLE OF CONTENTS

---

IC-M801E .....	A
AT-141 .....	B

# SERVICE MANUAL

MF/HF MARINE TRANSCEIVER

# IC-M801E

---

## SECTION 1 SPECIFICATIONS

## SECTION 2 INSIDE VIEWS

## SECTION 3 CIRCUIT DESCRIPTION

3-1 RECEIVER CIRCUITS.....	A-3-1
3-2 TRANSMITTER CIRCUITS .....	A-3-3
3-3 PLL CIRCUITS .....	A-3-5
3-4 DSC CIRCUITS .....	A-3-6
3-5 REG-DC CIRCUIT .....	A-3-7
3-6 POWER SUPPLY CIRCUITS .....	A-3-8
3-7 PORT ALLOCATIONS .....	A-3-8

## SECTION 4 ADJUSTMENT PROCEDURES

## SECTION 5 PARTS LIST

## SECTION 6 MECHANICAL PARTS AND DISASSEMBLY

## SECTION 7 SEMI-CONDUCTOR INFORMATION

## SECTION 8 BOARD LAYOUTS

8-1 RC-25E	
8-1-1 DISPLAY-A BOARD .....	A-8-1
8-1-2 CONNECT-A BOARD .....	A-8-3
8-1-3 SENSOR-A BOARD .....	A-8-3
8-1-4 VR-A BOARD.....	A-8-4
8-2 IC-M801E	
8-2-1 DSP BOARD.....	A-8-3
8-2-2 MAIN UNIT .....	A-8-5
8-2-3 FILTER UNIT .....	A-8-7
8-2-4 PLL UNIT .....	A-8-9
8-2-5 PA UNIT .....	A-8-10
8-2-6 REG-DC UNIT .....	A-8-11
8-2-7 DRIVER BOARD.....	A-8-11
8-2-8 VARISTAR-1 BOARD.....	A-8-11
8-2-9 VARISTAR-2 BOARD.....	A-8-12

## SECTION 9 BLOCK DIAGRAM

## SECTION 10 WIRING DIAGRAM

## SECTION 11 VOLTAGE DIAGRAMS

11-1 RC-25E.....	A-11-1
11-2 MAIN UNIT .....	A-11-2
11-3 PA UNIT.....	A-11-6
11-4 FILTER UNIT .....	A-11-7
11-5 PLL UNIT.....	A-11-7
11-6 DSP BOARD .....	A-11-9
11-7 REG-DC UNIT .....	A-11-10

# SECTION 1 SPECIFICATIONS

## ■ General

- Frequency coverage : (Unit: MHz)
  - Receive 0.5–29.9999
  - Transmit 1.6–2.9999 4.0–4.9999
  - 6.0–6.9999 8.0–8.9999
  - 12.0–13.9999 16.0–17.9999
  - 18.0–19.9999 22.0–22.9999
  - 25.0–27.5000
- DSC channels : 2.1875 MHz, 4.2075 MHz, 6.3120 MHz, 8.4145 MHz, 12.5770 MHz, 16.8045 MHz
- Type of emission :
  - Transceiver J3E (USB/LSB\*), H3E,\* J2B (AFSK), F1B (FSK), A1A\* (CW)
  - DSC receiver F1B
- No. of memory Ch. : 1205 channels (max.)
  - 160 user programmable, 249 ITU SSB duplex, 124 ITU SSB simplex, 662 ITU FSK duplex and 10 Semi/Auto channels
- Antenna connector : SO-239×2 (50 Ω)
- Usable temp. range : –15°C to +55°C
- Frequency stability : ±10 Hz  
(Approx. 5 min. after battery connection.)
- Power supply :
  - 12 V DC version 10.8–15.6 V DC (floating ground)
  - 24 V DC version 21.6–31.2 V DC (floating ground)
- Current drain :
  - 12 V DC version
    - Transmit at max. power 60 A
    - Receive at max. audio Less than 6.0 A
  - 24 V DC version
    - Transmit at max. power 30 A
    - Receive at max. audio Less than 3.0 A
- Dimensions (projections not incl.):
  - Main unit 367(W)×95(H)×260(D) mm
  - Controller (RC-25E) 220(W)×110(H)×84.4(D) mm
  - Speaker (SP-24E) 110(W)×110(H)×84.4(D) mm
- Weight (approx.) :
  - Main unit 8.5 kg
  - Controller (RC-25E) 570 g
  - Speaker (SP-24E) 370 g
- CONTROLLER connector: 8-pin connector
- GPS connector : RCA (NMEA0183 ver. 3.01)
- REMOTE connector : D-sub 9-pin (RS-232C/NMEA)
- AF/MOD connector : D-sub 9-pin
- PRINTER connector : D-sub 25-pin

## ■ Transmitter

- Output power :
  - 1.6–3.9999 MHz 85 W p-p
  - 4.0–27.5000 MHz 125 W p-p
- Spurious emission : 43 dB below peak output power
- Carrier suppression : 40 dB below peak output power
- Unwanted sideband suppression : 55 dB below peak output power (w/1 kHz AF input; at max power)
- Mic. connector : 8-pin connector (2.4 kΩ)

## ■ Receiver

- Sensitivity :
  - Transceiver
    - J3E, A1A 30 dBμV emf (0.5–1.5999 MHz)
    - (20 dB SINAD) 13 dBμV emf (1.6–1.7999 MHz)
    - 8 dBμV emf (1.8–29.9999 MHz)
  - J2B, F1B 13 dBμV emf (1.6–1.7999 MHz)
  - (20 dB SINAD) 8 dBμV emf (1.8–29.9999 MHz)
  - H3E 44 dBμV emf (0.5–1.5999 MHz)
  - (20 dB SINAD) 30 dBμV emf (1.6–1.7999 MHz)
  - 24 dBμV emf (1.8–3.9999 MHz)
- DSC receiver 0 dBμV emf (all channels)
- Spurious response rejection ratio:
  - Transceiver
    - More than 70 dB (0.5–29.9999 MHz)
  - DSC receiver
    - More than 60 dB (1st image)
    - More than 50 dB (except 1st image)
- AF output power : More than 4.0 W at 10% distortion with a 4 Ω load  
(at 13.2 V DC)
- CLARITY variable range: ±150 Hz
- Headphone connector : 3-conductor 3.5 (d) mm
- SP connector : 2-conductor 3.5 (d) mm/4 Ω

**All stated specifications are typical and subject to change without notice or obligation.**

## SECTION 2 INSIDE VIEWS

### • RC-25E

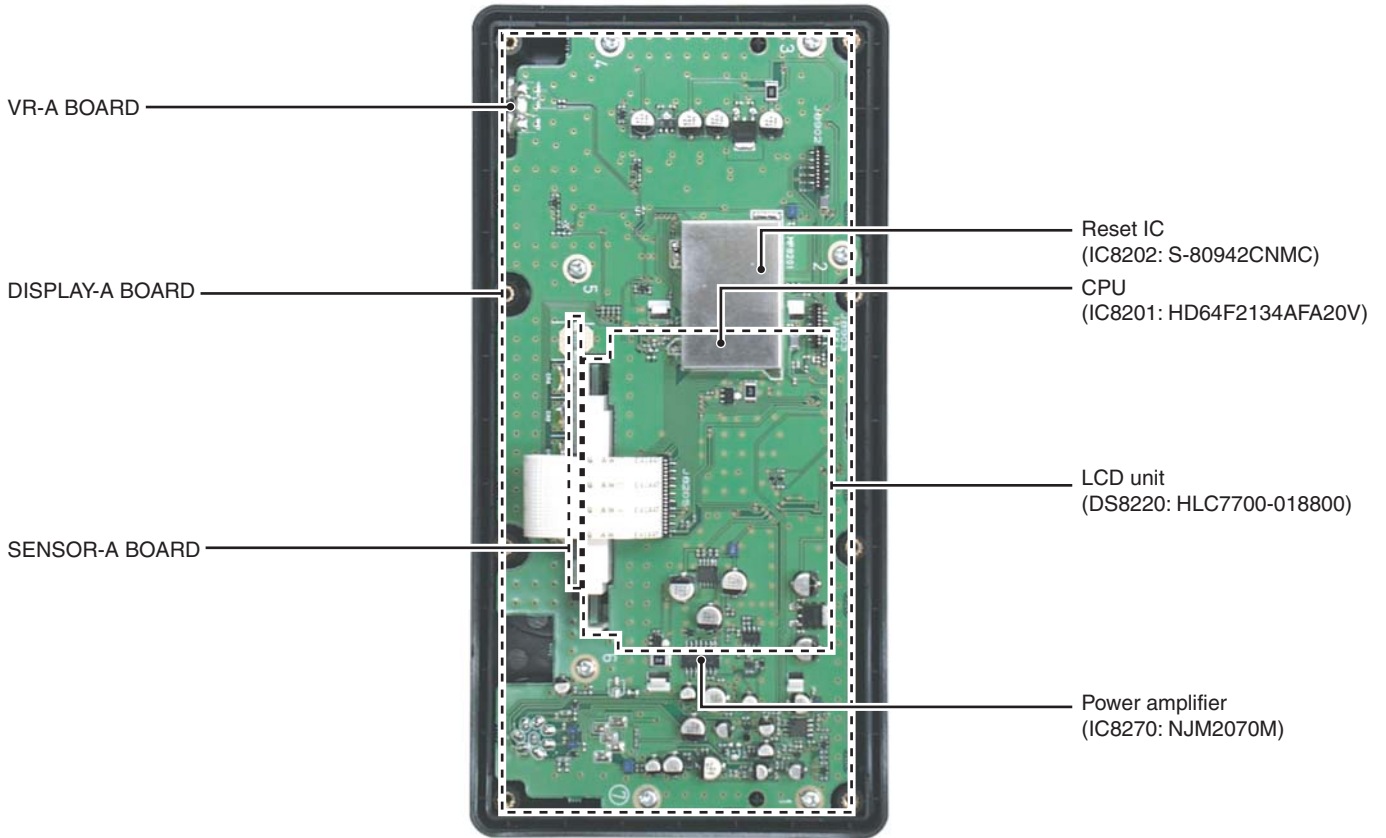

### • FILTER UNIT

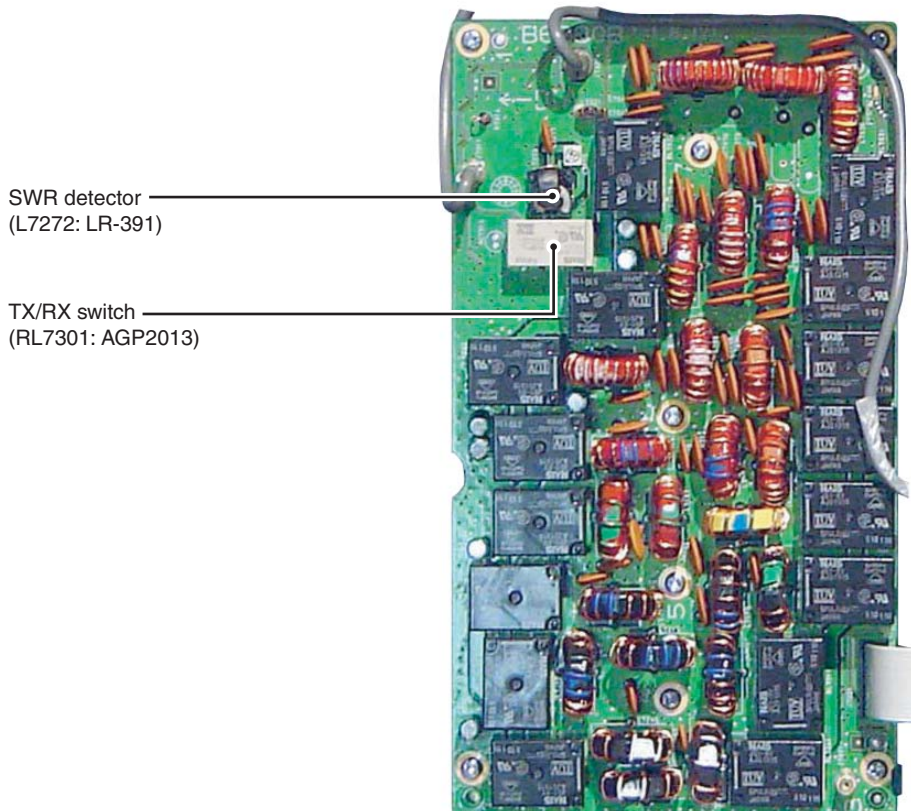

• MAIN UNIT

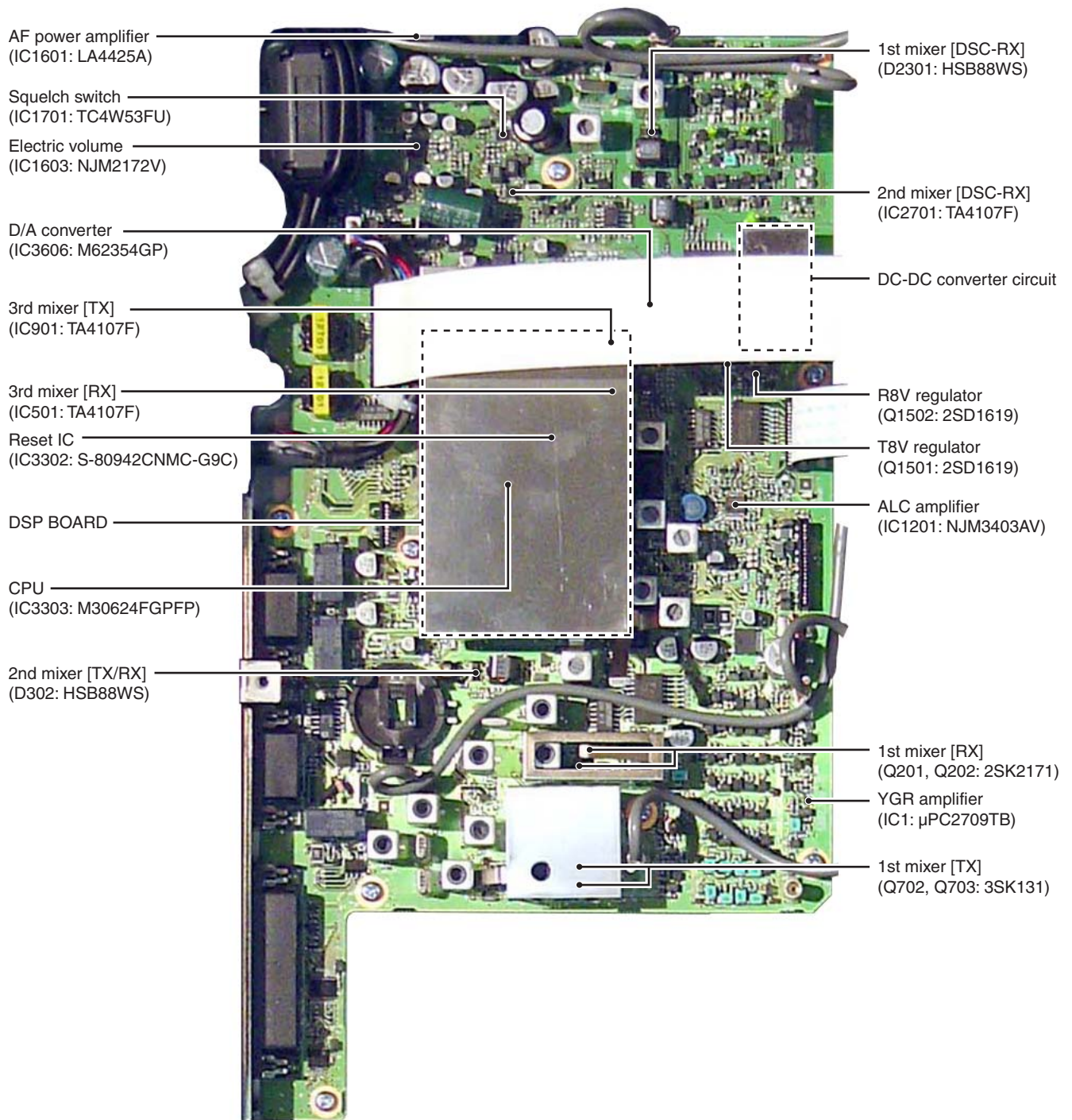



• PLL UNIT

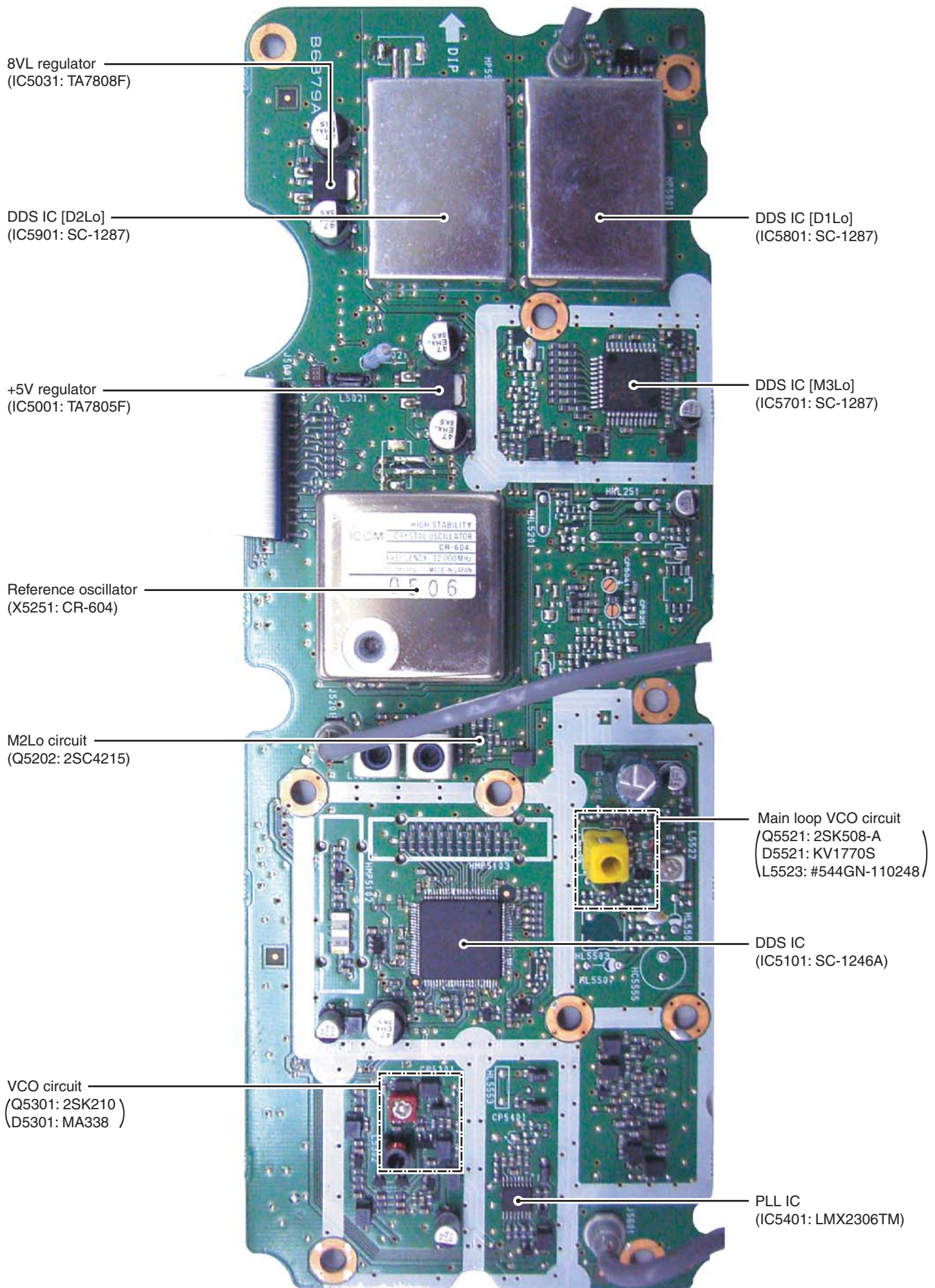

8VL regulator  
(IC5031: TA7808F)

DDS IC [D2Lo]  
(IC5901: SC-1287)

+5V regulator  
(IC5001: TA7805F)

Reference oscillator  
(X5251: CR-604)

M2Lo circuit  
(Q5202: 2SC4215)

VCO circuit  
(Q5301: 2SK210 )  
(D5301: MA338 )

DDS IC [D1Lo]  
(IC5801: SC-1287)

DDS IC [M3Lo]  
(IC5701: SC-1287)

Main loop VCO circuit  
(Q5521: 2SK508-A  
D5521: KV1770S  
L5523: #544GN-110248 )

DDS IC  
(IC5101: SC-1246A)

PLL IC  
(IC5401: LMX2306TM)

• PA UNIT

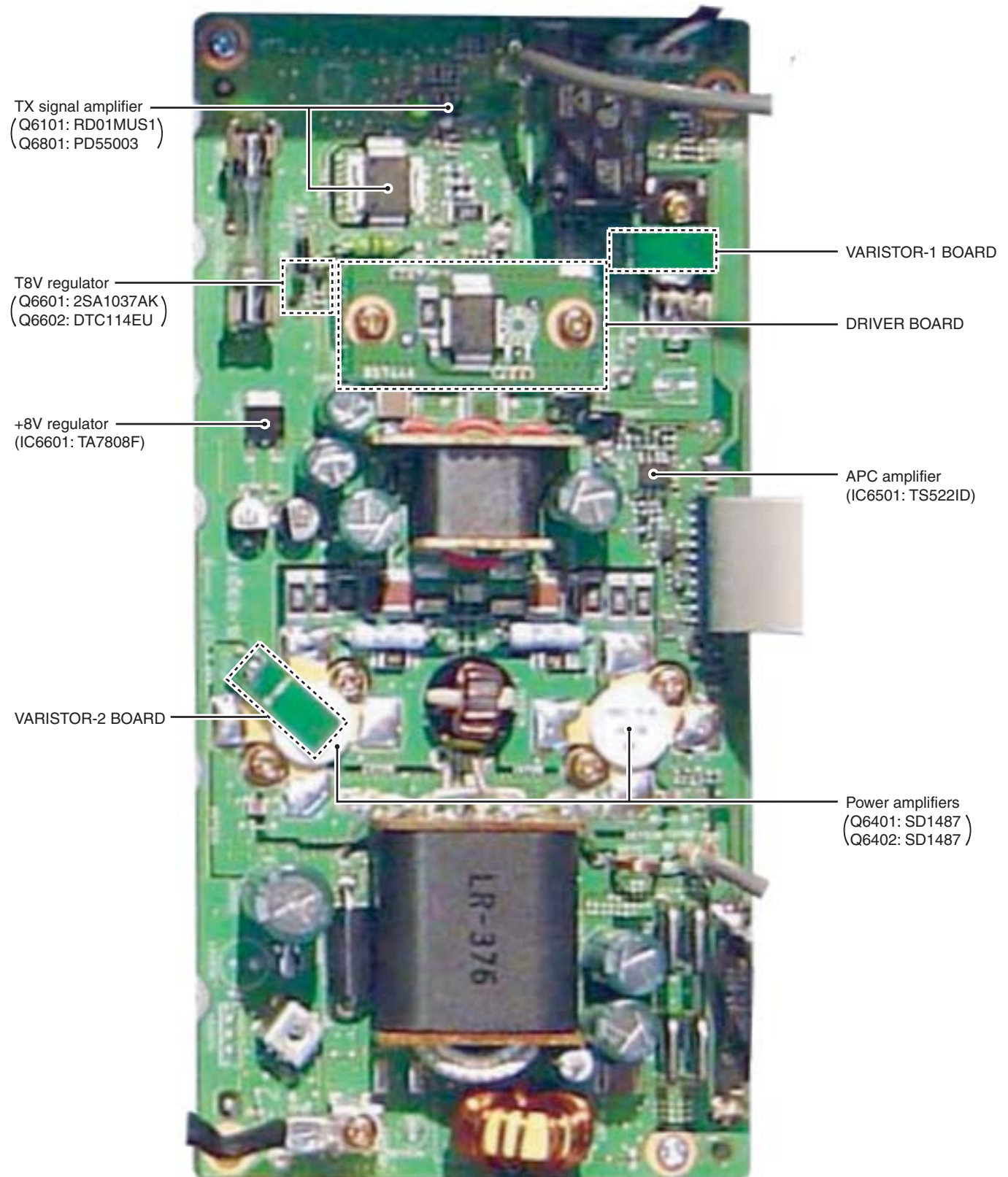

• REG-DC UNIT

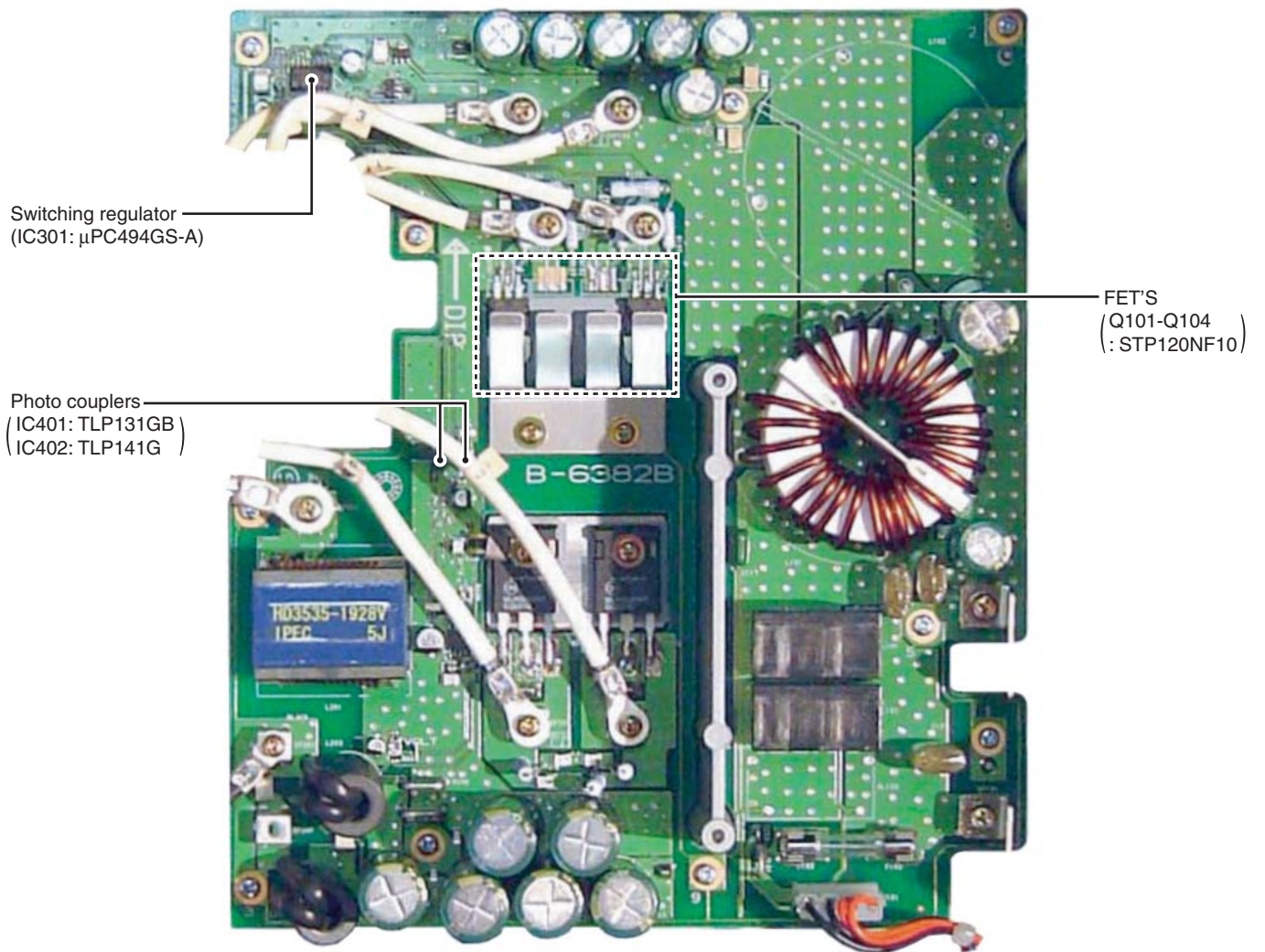

# SECTION 3 CIRCUIT DESCRIPTION

## 3-1 RECEIVER CIRCUITS

### 3-1-1 RF FILTER CIRCUIT (MAIN UNIT)

Received signals from the antenna connector (CHASSIS; J4501) are applied to the TX/RX switch (FILTER unit; RL7301) which is controlled by the CPU (IC3303) as the "TRXS" signal. The switched signals pass through the 30 MHz cut-off low-pass filter (FILTER unit; L7321, C7321-C7323, C7325), and then applied to the MAIN unit via J51.

The filtered signals pass through the 1.6 MHz cut-off high-pass filter (L51-L54, C54, C56, C57, C59, C61-C64) and TX/RX switch (D53), and are then applied to one of the bandpass filters (including one low-pass filter for below 2.0 MHz). These filters are selected by the filter control signals (B0-B8) as described in the table below.

#### BANDPASS FILTERS USED

Frequency (MHz)	Control signal	Entrance coil	Frequency (MHz)	Control signal	Entrance coil
0.5-1.999	B0	L101	10-13.999	B5	L110
2-2.999	B1	L102	14-17.999	B6	L112
3-4.999	B2	L104	18-23.999	B7	L114
5-6.999	B3	L106	24-29.999	B8	L116
7-9.999	B4	L108			

The filtered signals pass through the 33 MHz cut-off low-pass filter (L202, L203, C202-C206, C226) via the TX/RX switch (D201), and are then applied to the 1st mixer circuit.

### 3-1-2 1ST MIXER AND IF CIRCUITS (MAIN UNIT)

The 1st mixer circuit converts the received signals into a fixed frequency of the 1st IF signal with a PLL output frequency. By changing the PLL frequency, only the desired frequency is picked up at bandpass filter at the next stage of the 1st mixer circuit.

The filtered RF signals are applied to the 1st mixer circuit (Q201, Q202) to mixed with 1st LO signals coming from the PLL circuit to produce a 64.455 MHz 1st IF signal.

The 1st LO signal from the PLL unit is applied to the MAIN unit via J601 and then amplified at the 1st LO amplifier (Q601). The amplified signal is passed through the 100 MHz cut-off low-pass filter (L604, L605, C606-C610) to suppress harmonics components, and then applied to the 1st mixer circuit (Q201, Q202) via the TX/RX switch (D602).

The converted 1st IF signal is passed through the bandpass filter (FI201) and then amplified at the IF amplifier (Q203). The amplified signal is passed through the TX/RX switch (D301) and pair of the crystal filters (FI301a, FI301b) and then applied to the 2nd mixer circuit.

### 3-1-3 2ND MIXER AND IF CIRCUITS (MAIN UNIT)

The 2nd mixer circuit converts the 1st IF signal into a 2nd IF signal.

The filtered 1st IF signal from the crystal filter (FI301b) is mixed with a 64 MHz 2nd LO signal, coming from the PLL circuit, at the 2nd mixer circuit (D302, L303, L304) to convert into a 455 kHz 2nd IF signal.

The converted 2nd IF signal passes through the low-pass filter (L305, L306, C308-C311, C315) and TX/RX switch (D303), and then applied to the IF amplifier (Q401) via the ceramic bandpass filter (FI401). The amplified signal passes through the ceramic bandpass filter (FI402) via the RX switch (D401), and then applied to the 3rd mixer circuit after being amplified at the IF amplifier (Q501).

### 3-1-4 3RD MIXER AND IF CIRCUITS (MAIN UNIT)

The 3rd mixer circuit converts the 2nd IF signal into a 3rd IF signal.

The 2nd IF signal is mixed with a 443 kHz 3rd LO signal, coming from the PLL circuit, at the 3rd mixer circuit (IC501) to convert into a 12 kHz 3rd IF signal.

The converted 3rd IF signal is applied to the IF amplifier (IC1002, pins 1, 3) and then passed through the low-pass filter (IC1002, pins 5, 7).

The filtered signal is applied to the DSP circuit via the TX/RX switch (IC1001, pins 1, 7).

## RECEIVER CONSTRUCTION

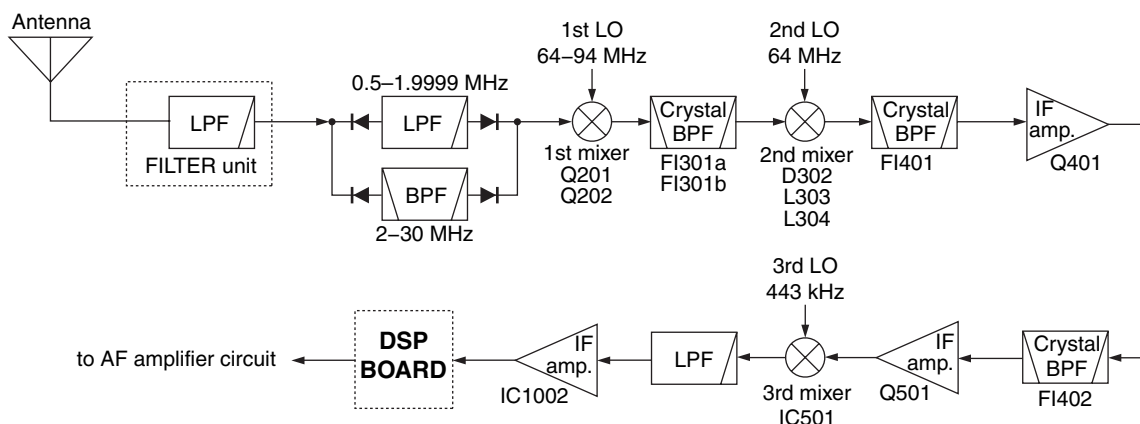

### 3-1-5 DSP RECEIVER CIRCUIT (DSP BOARD)

The DSP (Digital Signal Processor) circuit enables digital IF filter, digital PSN (Pulse Shift Network), phase demodulation, and etc.

The switched 3rd IF signal from the TX/RX switch (MAIN unit; IC1001) is amplified at the differential amplifiers (IC651, pins 1, 2, 6, 7), and is then applied to the A/D converter (IC501). The converted 3rd IF signal is applied to the DSP IC (IC301) for the digital IF filter and demodulation, etc. The output signal from the DSP IC is applied to the D/A converter (IC501) to convert into the analog AF signals.

The converted analog AF signals are passed through the active filter (IC701, pins 1, 3), and then applied to the MAIN unit via J901 (pin 17) as the DSPO1 signal.

### 3-1-6 AF AMPLIFIER CIRCUIT (MAIN UNIT)

The AF amplifier amplifies the AF signals to the suitable driving level for the speaker.

The AF signals from the DSP board, "DSPO1," are passed through the TX/RX switch (IC1703, pins 1, 7), and then passed through the low-pass filter (IC1702, pins 5, 6) after being amplified at AF amplifier (IC1702, pins 1, 3). The filtered signal passes through the SQL switch (IC1701, pins 1, 7) which is controlled by the "SQLC" signal coming from the CPU (IC3303, pin 49). The switched signals are applied to the electronic volume IC (IC1603, pin 1) which can control the audio level by AFG voltage from the CPU (IC3303) via the D/A converter (IC3606, pin 6).

The beep, tone, side tone and monitor signals are applied to the electronic volume IC (IC1603) too.

The output signals are applied to the AF mute switch (IC1602, pins 1, 7), and then amplified at the AF power amplifier (IC1601, pins 1, 4). The power amplified AF signals are applied to the speaker (SP-24E) that is connected [SP] jack (CHASSIS; W4510) via J1451 (pin 3).

### 3-1-7 AGC CIRCUIT (DSP BOARD)

The AGC (Automatic Gain Control) circuit reduces IF amplifier gain and attenuates IF signal to keep the audio output at a constant level.

The receiver gain is determined by the voltage of the AGC1 line from the D/A converter (IC102) and set with RF gain setting.

The AGC voltage is detected at the AGC detector section in the DSP IC (IC301). The detected signal from the DSP IC is applied to the level converter (IC101) and applied to the D/A converter (IC102). The converted AGC voltage is amplified at the buffer amplifier section in the D/A converter (IC102) and applied to the AGC amplifier (MAIN unit; IC1101, pins 1, 2) to control the MAGC line.

When receiving strong signals, the detected voltage increases and the AGC1 voltage decreases. As the AGC1 voltage is used for the bias voltage of the IF amplifiers (MAIN unit; Q203, Q401, Q501), IF amplifier gain is decreased.

#### • DSP CIRCUIT

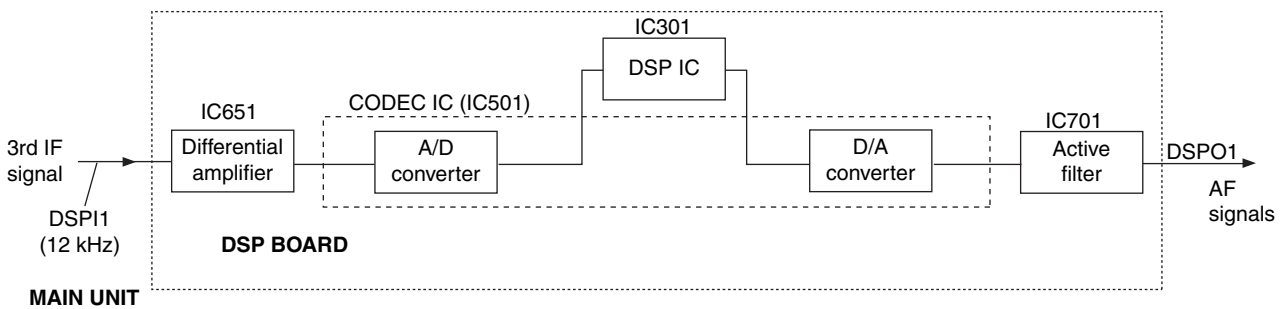

#### • AGC CIRCUIT

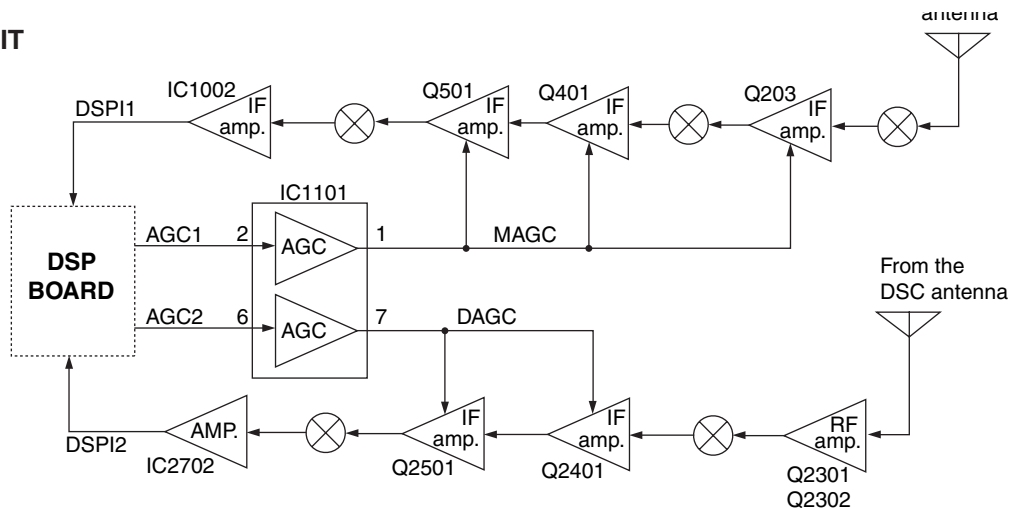

## 3-2 TRANSMITTER CIRCUITS

### 3-2-1 MICROPHONE AMPLIFIER CIRCUIT (RC-25E AND MAIN UNIT)

The microphone amplifier circuit amplifies microphone audio signal to a level needed for the DSP circuit.

The audio signals from the [MIC] connector (RC-25E; J8701, pin 1) are amplified at the AF amplifier (RC-25E; IC8280, pins 1, 3), and then applied to the MOD switch (MAIN unit; IC2001, pins 3, 4) via the J2051 (MAIN unit). The switched signals are applied to the limiter amplifier (MAIN unit; IC1051, pins 1, 3) and then passed through the low-pass filter (MAIN unit; IC1051, pins 5, 7).

The filtered signals are applied to the DSP circuit after passed through the TX/RX switch (IC1001, pins 1, 6).

### 3-2-2 DSP TRANSMITTER CIRCUIT (DSP BOARD)

The DSP (Digital Signal Processor) circuit enables PSN (Phase Shift Network)/Low Power/Phase modulator, and etc.

The switched audio signals from the TX/RX switch (MAIN unit; IC1001, pin 1) are amplified at the differential amplifiers (IC651, pins 1, 2, 6, 7), and are then applied to the A/D converter (IC501).

The converted audio signals are applied to the DSP IC (IC301) and modulated to produce the 12 kHz 3rd IF signal.

The modulated IF signal from the DSP IC (IC301) is applied to the D/A converter (IC501) to convert into the analog 3rd IF signal.

The converted 3rd IF signal is passed through the active filter (IC701, pins 1, 2), and then applied to the MAIN unit via J901 (pin 17).

### 3-2-3 SPEECH COMPRESSOR CIRCUIT (DSP BOARD)

The speech compressor compresses the transmitter audio input signals to increase the average output level (average talk power).

When the speech compressor function is ON, the converted signal from the A/D converter (IC501) are applied to the compressor section in the DSP IC (IC301) to obtain an averaged audio level.

At the same time, the compressed signals are modulated at the DSP IC and applied to the D/A converter (IC501).

### 3-2-4 IF AMPLIFIER AND MIXER CIRCUITS (MAIN UNIT)

The modulated 3rd IF signal from the DSP board ("DSPO1" signal: 12 kHz) passes through the TX/RX switch (IC1703, pins 1, 6), and then applied to the 3rd mixer circuit (IC901, pin 3) to convert into the 2nd IF signal. The applied 3rd IF signal is mixed with the 3rd LO signal from the DDS circuit (PLL unit; IC5701) to produce a 455 kHz 2nd IF signal.

The converted 2nd IF signal is output from pin 5 of the 3rd mixer circuit (IC901) and passes through the ceramic filter (FL402) to suppress the unwanted signals via the TX switch (D404). The filtered 2nd IF signal is amplified at the 2nd IF amplifier (Q801) via the TX switch (D403), and then applied to the 2nd mixer circuit (D302) after being passed through the TX/RX switch (D303) and low-pass filter (L305, L306, C308–C311, C315).

The applied 2nd IF signal is mixed with a 64 MHz 2nd LO signal, coming from the PLL circuit, at the 2nd mixer circuit (D302, L302, L303) to convert into a 64.455 MHz 1st IF signal. The 1st IF signal is passed through a pair of the crystal filters (FI301a, FI301b) to suppress the unwanted signals. The filtered 1st IF signals are mixed with the 1st LO signal, coming from the PLL circuit, at the 1st mixer circuit (Q702, Q703) to obtain the desired RF signal via the TX/RX switch (D301) and attenuator (R712, R715, R716).

The converted RF signal is passed through the low-pass filter (L702, L703, C706, C707, C709–C711, C721) and then amplified at the RF amplifier (Q701).

## • TRANSMIT CONSTRUCTION

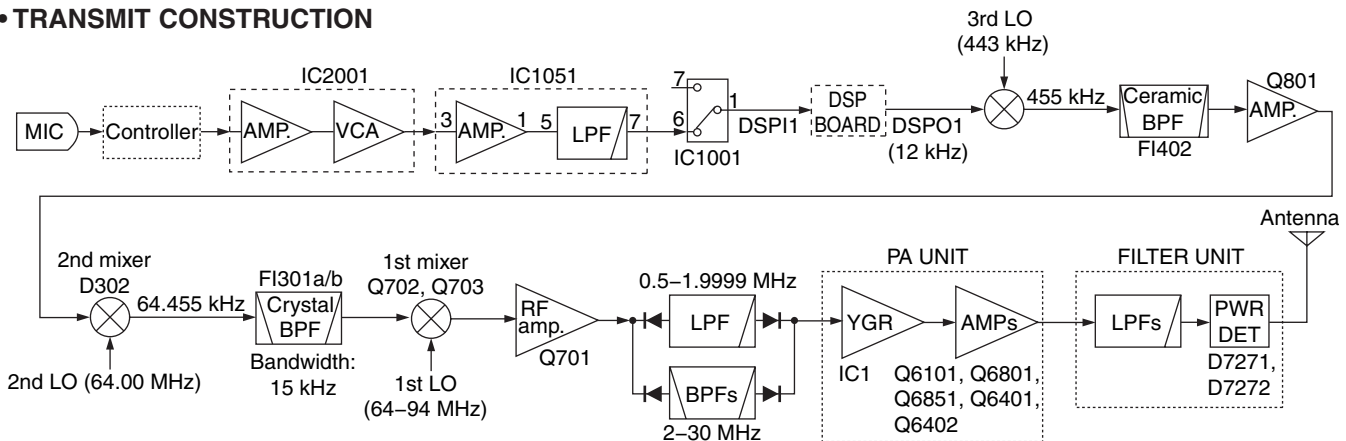

### 3-2-5 RF CIRCUIT (MAIN, PA UNITS AND DRIVER BOARD)

The RF circuit amplifies operating (transmitting) frequency to obtain 150 W of RF output.

The signal from the RF amplifier (MAIN unit; Q701) is passed through one of the low-pass filter or bandpass filters (Refer to the table on page 3-1 Bandpass filters used), and then applied to the YGR amplifier (MAIN unit; IC1, pins 1, 4) after being passed through the TX/RX switch (MAIN unit; D53) and attenuator (MAIN unit; R5–R7). The amplified signal passes through the low-pass filter (MAIN unit; L1–L2, C1–C5) and attenuator (MAIN unit; R1–R3, R9), and then applied to the PA unit via J1 (MAIN unit).

The attenuated signal from the MAIN unit is amplified at 2 amplifiers (PA unit; Q6101, Q6801) after passed through the attenuator (PA unit; R6101–R6103) and low-pass filter (PA unit; L6101, C6101, C6102). The amplified signal is applied to the drive amplifier (DRIVER board; Q6851) and power amplifiers (PA unit; Q6401, Q6402) to obtain a stable 150 W of RF output power.

The power amplified RF signal is applied to the filter unit via the J6401.

### 3-2-6 FILTER CIRCUIT (FILTER UNIT)

The power amplified signal is applied to one of the 8 low-pass filters which are composed of chebychev type.

#### LOW-PASS FILTERS USED

Frequency (MHz)	Control signal	Entrance relay	Frequency (MHz)	Control signal	Entrance relay
1.6–1.999	L1M	RL7031	7–9.999	L8M	RL7151
2–2.999	L2M	RL7061	10–13.999	L12M	RL7181
3–4.999	L4M	RL7091	14–19.999	L16M	RL7211
5–6.999	L6M	RL7121	20–29.999	L22M	RL7241

The filtered signal from the low-pass filter is applied to the antenna connector (CHASSIS unit; J4501) after being passed through the TX/RX switch (RL7301) and J7311.

### 3-2-7 ALC CIRCUIT (MAIN UNIT)

The ALC (Automatic Level Control) circuit controls the gain of IF amplifier in order for the transceiver to output a constant RF power even when the supplied voltage shifts, etc.

The RF power level is detected at the power detector (FILTER unit; D7271) to be converted into DC voltage and applied to the MAIN unit as the FOR signal.

The FOR signal is applied to the ALC amplifier (IC1201, pin 2). The “POCV” signal is applied to the other input (IC1201, pin 3) for reference. The compared signal is output from pin 1 and applied to the IF amplifier (Q801) to control amplifying gain.

When the FOR signal exceeds the POCV voltage, ALC bias voltage from the comparator (IC1201, pin 1) controls the IF amplifiers. This adjusts the output power to a specified level until the FOR and POCV voltages are equalized.

### 3-2-8 APC CIRCUIT (FILTER AND MAIN UNITS)

The APC (Automatic Power Control) circuit protects the power amplifiers on the PA unit from high SWR and excessive current.

#### • SWR APC CIRCUIT (FILTER AND MAIN UNITS)

The reflected signal appears and increases on the antenna connector. When the antenna is mismatched, the power detector (FILTER unit; D7272) detects the reflected signal and applies it to the APC amplifier (MAIN unit; IC1201, pins 8, 9) as “REF” signal. The output signal from the APC amplifier (IC1201, pin 1) decreases the bias voltage of the IF amplifier (Q801) to reduce the output power.

#### • RF FILTER CIRCUIT

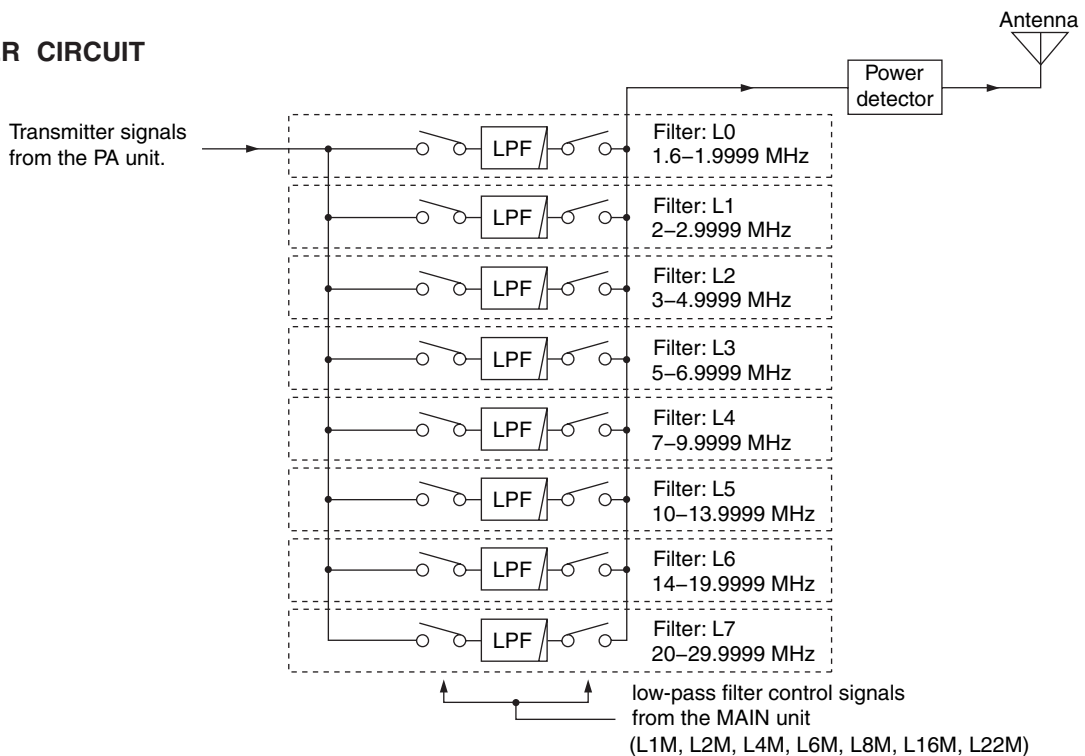

• **CURRENT APC CIRCUIT (PA UNIT)**

The driving current at the power amplifiers (Q6401, Q6402) is detected at the current detector (R6651–R6654) by measuring the voltage difference between both terminals of the detector. The detected voltages are applied to the differential amplifier (IC6501, pins 1, 2, 3).

When the driving current of the power amplifiers (Q6401, Q6402) exceed 30 A, the detected voltage is applied to the APC amplifier (MAIN unit; IC1201, pins 6, 7) to reduce the gate-2 voltage of the IF amplifier (MAIN unit; Q801) and then reduce the output power.

**3-2-9 RF METER CIRCUIT (MAIN UNIT)**

A portion of the “FOR” signal is also applied to the meter amplifier (IC1201, pins 12, 14) for meter indication. The amplified signal is applied to the CPU (IC3303, pin 97) as “RFML” signal.

For antenna current meter indication, the “ANTM” signal from the optional AT-141 is applied to the meter amplifier (IC1201, pins 12, 14) via the J1901 (pin 9).

**3-3 PLL CIRCUITS**

**3-3-1 GENERAL**

The PLL circuits generate reference (32.000 MHz), 1st LO (64.485–94.455 MHz), 2nd LO (64 MHz), 3rd LO (443.000 kHz), DSC 1st LO (12.8875–27.5045 MHz) and DSC 2nd LO (10.7103 MHz) frequencies.

**3-3-2 REFERENCE OSCILLATOR CIRCUITS (PLL UNIT)**

The reference oscillator (X5251) generates a 32.0 MHz frequency for the reference loop VCO and 3rd LO circuits. The generated 32.0 MHz signal is doubled at doubler circuit (Q5202) and then the doubled 64.0 MHz signal is applied to the DSC LO and 2nd LO circuits.

**3-3-3 1ST LO PLL CIRCUIT (PLL UNIT)**

The 1st LO PLL contains main and reference loops as a dual loop system.

The reference loop generates an approximate 10.5 MHz frequency using DDS, and the main loop generates within 64.485 to 94.455 MHz frequency using the reference loop frequency.

**(1) REFERENCE LOOP PLL**

The oscillating signal at the reference loop VCO (Q5301, D5301) is amplified at the amplifiers (Q5302, Q5351) and is then applied to the programmable divider section of the DDS IC (IC5101, pin 46). The applied signal is then divided and detected on phase with the 32.0 MHz reference frequency.

The detected signal from the DDS IC (pin 56) is converted into DC voltage (lock voltage) at the loop filter (R5136, R5146, C5112) and then applied to the reference loop VCO circuit (Q5301, D5301).

The buffer amplified reference loop VCO signal from the buffer amplifier (Q5302) is also applied to the PLL IC (IC5401) for MAIN loop PLL as the reference frequency.

**(2) MAIN LOOP PLL**

The oscillating signal from the main loop VCO (Q5521, D5521, L5523) is amplified at the buffer (Q5601) and LO (Q5604) amplifiers and is then applied to the PLL IC (IC5401, pin 6). The applied signal is then divided and detected on phase with the reference loop output frequency.

The detected signal from the PLL IC (IC5401, pin 2) is converted into a DC voltage (lock voltage) at the loop filter and then applied to the VCO circuit (Q5521, D5521, L5523).

The buffer amplified main loop VCO signal from the buffer amplifier (Q5601) is amplified at the LO (Q5602) and buffer (Q5603) amplifiers and then passed through the bandpass filter (L5602–L5604, C5609–C5616).

The filtered signal is applied to the 1st mixer circuit (MAIN unit; Q201, Q202 for RX, Q702, Q703 for TX) as a 1st LO signal (64.485–94.455 MHz).

• **ALC AND APC CIRCUITS**

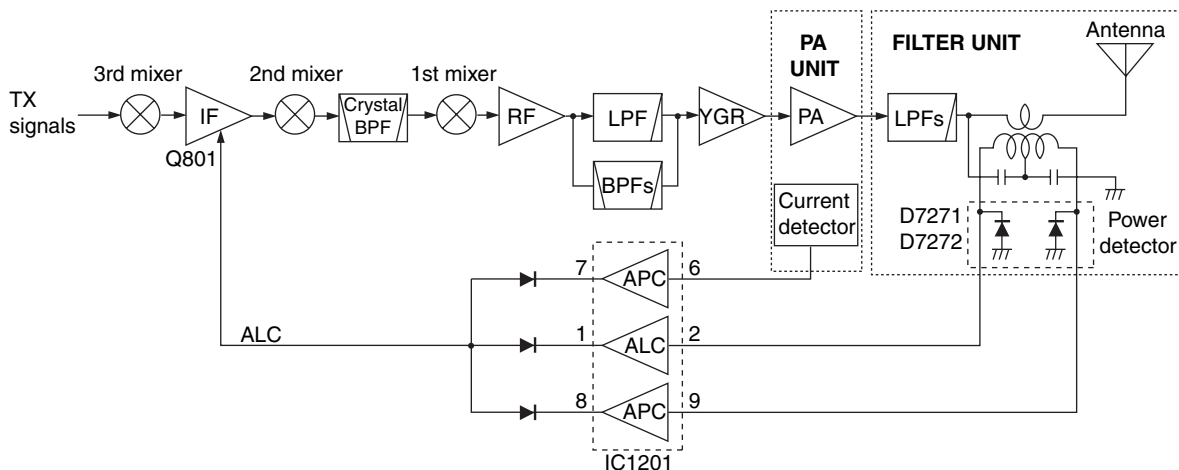



### 3-3-4 2ND LO CIRCUITS (PLL UNIT)

The 64.0 MHz reference frequency from the reference oscillator circuit is applied to the 2nd mixer circuit (MAIN unit; D302) as a 2nd LO signal (64.0 MHz).

### 3-3-5 3RD LO CIRCUIT (PLL UNIT)

The DDS IC (IC5701) generates a 10-bit digital signal using the 32.0 MHz system clock from the reference oscillator circuit.

The digital signal (IC5701, pins 13–17, 19–23) is converted into an analog wave signal at the D/A converter (R5701–R5720). The converted analog wave signal is passed through the bandpass filter (L5781–L5783, C5781–C5785) and then applied to the 3rd mixer circuit (MAIN unit; IC501 for RX, IC901 for TX) as the 3rd LO signal (443.000 kHz) via the attenuator (R5781–R5783).

### 3-3-6 DSC 1ST LO CIRCUIT (PLL UNIT)

The DDS IC (IC5801) generates a 10-bit digital signal using the 64.0 MHz system clock from the reference oscillator circuit.

The digital signal (IC5801, pins 13–17, 19–23) is converted into an analog wave signal at the D/A converter (R5601–R5620). The converted analog wave signal is passed through the bandpass filter (L5681–L5683, C5685–C5789) and then amplified at the buffer (Q5801) and LO (Q5802) amplifiers. The amplified signal is applied to the DSC 1st mixer circuit (MAIN unit; D2301) as the DSC 1st LO signal (12.887–27.5045 MHz).

### 3-3-7 DSC 2nd LO CIRCUIT (PLL UNIT)

The DDS IC (IC5901) generates a 10-bit digital signal using the 64.0 MHz system clock from the reference oscillator circuit.

The digital signal from the DDS IC (IC5901, pins 13–17, 19–23) is converted into an analog wave signal at the D/A converter (R5901–R5920). The converted analog wave signal is passed through the bandpass filter (L5981–L5983, C5982–C5986) and then applied to the DSC 2nd mixer circuit (MAIN unit; IC2701) as the DSC 2nd LO signal (10.7103 MHz).

## 3-4 DSC CIRCUITS

### 3-4-1 DSC BANDPASS FILTER AND RF AMPLIFIER CIRCUITS (MAIN UNIT)

The RF circuit filters out-of-band signals and amplifies signals within the range of frequency coverage.

The received signals from the antenna connector (CHASSIS; J4503) are applied to the mute switch (RL2101) via J2101 and then passed through one of the bandpass filters.

#### BANDPASS FILTERS USED

Frequency (MHz)	Control signal	Entrance diode
2–7 MHz	DBPL	D2201
8 MHz	DBPM	D2201
12 MHz	DBPN	D2202
16 MHz	DBPH	D2202

The filtered signals are amplified at the RF amplifiers (Q2301, Q2302), and then applied to the 1st mixer circuit (D2301).

## • PLL CIRCUIT

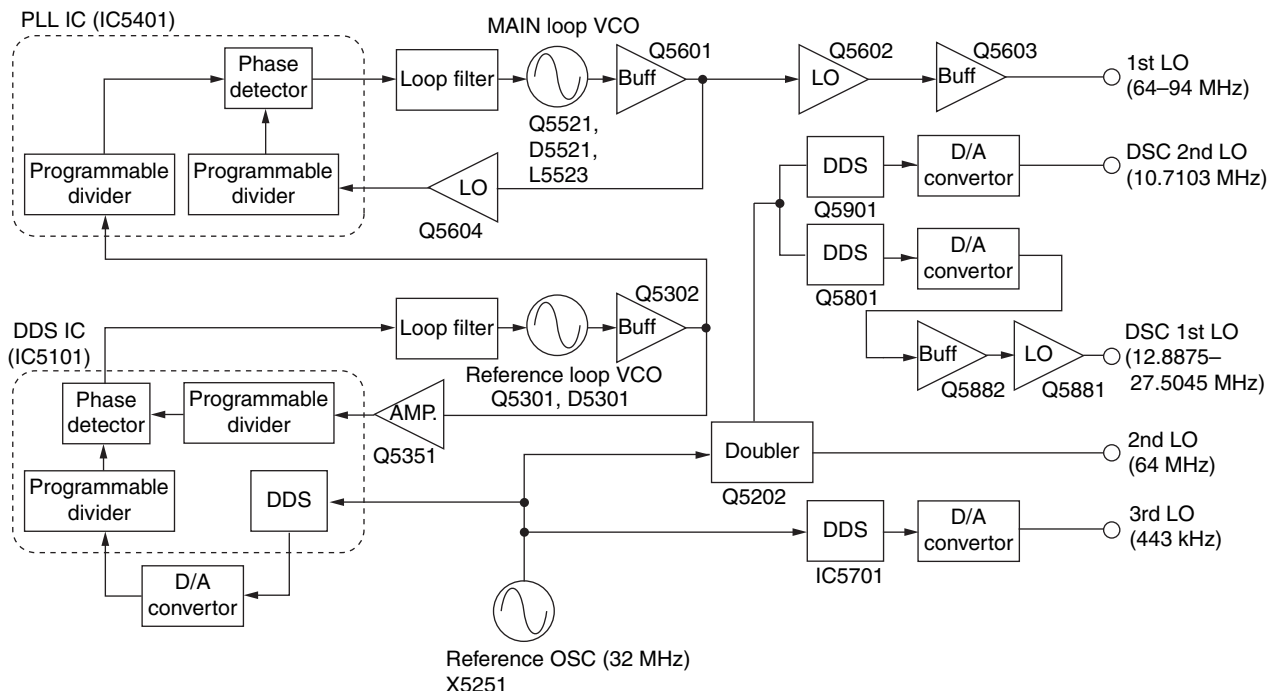

### 3-4-2 DSC 1ST MIXER AND 1ST IF CIRCUITS (MAIN UNIT)

The 1st mixer circuit converts the received signal into a fixed frequency of the 1st IF signal with a PLL output frequency.

The amplified signals from the RF amplifiers (Q2301, Q2302) are converted into the 10.7 MHz 1st IF signal at the 1st mixer circuit (D2301) and then passed through the crystal filters (FI231a, FI231b).

The filtered 1st IF signal is amplified at the 1st IF amplifiers (Q2401, Q2501) and then applied to the 2nd mixer circuit (IC2701, pin 3).

### 3-4-3 DSC 2ND IF AND DSP CIRCUITS (MAIN UNIT AND DSP BOARD)

The 2nd mixer circuit converts the 1st IF signal into a 2nd IF signal.

The amplified 1st IF signal from the 1st IF amplifier (MAIN unit; Q2501) is converted into the 12 kHz 2nd IF signal at the 2nd mixer IC (MAIN unit; IC2701, pins 3, 5) and then passed through the low-pass filter (MAIN unit; IC2702, pins 5, 7).

The filtered signal is applied to the DSP board as the "DSPI2" signal via J1102 (MAIN unit).

The "DSPI2" signal is amplified at the differential amplifier (DSP board; IC601, pins 1, 2, 6, 7), and is then applied to the A/D converter (DSP board; IC501) and DSP IC (DSP board; IC301).

The demodulated serial data from the DSP IC (DSP board; IC301) is applied to the CPU (MAIN unit; IC3303) and then analyzes the DSC signal data.

### 3-4-4 DSC AGC CIRCUIT (DSP BOARD)

The receiver gain is determined by the voltage on the AGC2 line from the DSP board.

The AGC voltage is detected at the AGC detector section in the DSP IC (IC301) and then applied to the level converter (IC101), D/A converter (IC102) and AGC amplifier (MAIN unit; IC1101, pins 6, 7) to control the DAGC line.

When receiving strong signals, the gain of the IF amplifiers (MAIN unit; Q2401, Q2501) is decreased.

### 3-5 REG-DC CIRCUIT (REG-DC UNIT)

The IC-M801E employs a floating grounding system which is not connected between transceiver's ground and (-) terminal of the DC power supply.

The DC voltage (13.8 V or 24 V) from the DC power supply is applied to the DC power terminals (CHASSIS; EP4501, EP4502) and then passed through the noise filter (L101, L102, C112-C114, C118-C120). The filtered voltage is applied to the switching amplifiers (Q101-Q104 for 12 V version, Q101-Q102 for 24 V version) and then applied to the transformer (T101).

The switching amplifier is controlled by the switching regulator controller (IC301) after being amplified at the drive amplifiers (Q301, Q302).

The output voltage from the transformer (T101) is applied to the rectifying circuit (D201, D202). The rectified DC voltages are passed through the noise filter (L8003, C8009, C8010), and are then applied to the PA unit as HV13V line via EP201, EP202.

## • DSC CIRCUIT

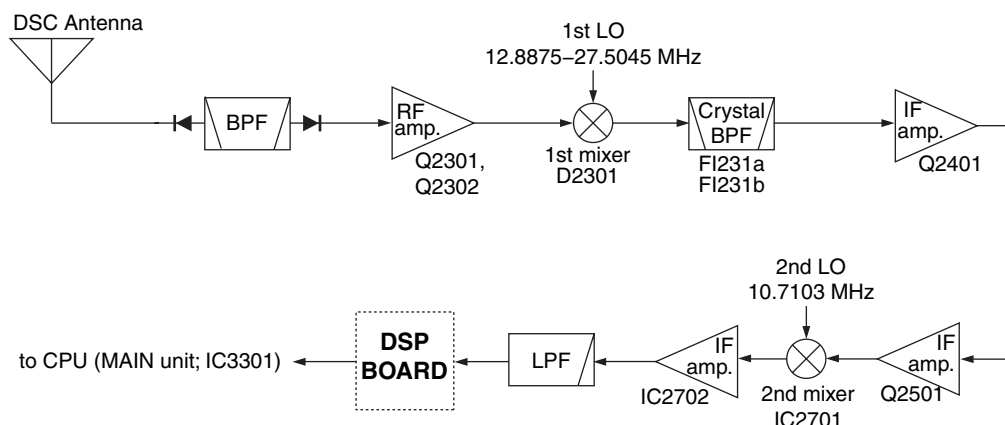

### 3-7 POWER SUPPLY CIRCUITS

#### 3-7-1 DISPLAY BOARD (RC-25E) VOLTAGE LINE

Line	Description
9V	Common 9 V converted from the H13V line at the +9 regulator circuit (IC8301).
5V	Common 5 V converted from the H13V at the +5 regulator circuit (IC8290).

#### 3-7-2 PA UNIT VOLTAGE LINE

Line	Description
HV13	The voltage from the REG-DC unit.
HV	The same voltage as the HV13 line passed through the fuse (F6701).
S13V	The same voltage as the HV13 line passes through the switching relay (RL6701).
PA8V	Common 8 V convert from the HV13 at the PA8V regulator circuit (IC6601).
PAT8	Transmit 8 V controlled by the PAT8 regulator circuit (Q6601, Q6602) using T8V.

#### 3-7-3 PLL UNIT VOLTAGE LINE

Line	Description
5V	Common 5 V converted from the S13V line and regulated by the +5 regulator circuit (IC5001).
8VL	Common 8 V converted from the S13V line and regulated by the +8 regulator circuit (IC5031).

#### 3-7-4 MAIN UNIT VOLTAGE LINE

Line	Description
R13V	Receive 13 V converted from the S13V line and regulated by the R13 regulator circuit (IC1303).
8V	Common 8 V converted from the S13V line at the +8 regulator circuit (IC1502).
-5V	Common -5 V converted from the S13V line at the -5 V regulator (IC1551, D1551, D1552)
T8	Transmit 8 V, converted from the S13V, controlled by T8 regulator circuit (Q1501, Q1502) using TXS signal from the CPU (IC1303).
R8	Receive 8 V, converted from the S13V, controlled by R8 regulator circuit (Q1502, Q1504) using RXS signal from the CPU (IC1303).
5V	Common 5 V converted from the S13V line and by the 5 V regulator circuit (IC1501) using RXS signal from the CPU (IC3303).
H5V	Common 5 V converted from the HV13V line and regulated by the +5 regulator circuit (IC3101).

### 3-8 PORT ALLOCATIONS

#### 3-8-1 MAIN CPU (MAIN UNIT; IC3303)

Pin number	Port name	Description
1	TXS1	Outputs T8 regulator circuit (MAIN unit; Q1501, Q1503) control signal. LOW : While transmitting.
2	RXS1	Outputs R8 regulator circuit (MAIN unit; Q1502, Q1504) control signal. LOW : While receiving.
3	PSEL	Outputs strobe signal to the expander IC (IC3601).
4	BEEP1	Outputs beep audio signals.
6	PDAT	Outputs serial data signal for the PLL circuits (PLL unit; IC5101, IC5401, IC5701, IC5801, IC5901).
7	PCK	Outputs clock signal for the PLL circuits (PLL unit; IC5101, IC5401, IC5701, IC5801, IC5901).
11	UNLK	Input port for PLL unlock signal. High: While PLL circuit is unlocked.
19	PWRS	Outputs the control signal for the switching relay (PA unit; RL6701). High : During power ON.
23	DRES	Outputs the RESET signal.
27	RQIR	Outputs strobe signal for the DSP board.
28	DO	Input port for serial data signal from the DSP board.
29	NMEI1	Input port for the NMEA signal from the connected unit via the remote connector (J9051).
30	NMEO1	Outputs the NMEA signal to the connected unit via the remote connector (J9051).
32	NMEI2	Input port for the GPS signal from connected unit via the remote connector (J9051).
33	LSTB	Outputs strobe signal for the expander IC (IC3602, IC3604).
34	DSTB	Outputs strobe signal for the D/A converter IC (IC3606).
37	LCK	Outputs clock signal for the expander IC (IC3602-IC3605), D/A converter IC (IC3606).
38	LDAT	Outputs serial data signal for the expander IC (IC3602, IC3603) and D/A converter IC (IC3606).
47	MSTB	Outputs strobe signal for the expander IC (IC3603, IC3605).
48	PSTB	Outputs strobe signal for the PLL unit via the D/A converter (IC3601).
49	SQLC	Outputs squelch control signal for the SQL switch (IC1701). HIGH : While squelch is closed.

**MAIN CPU (MAIN UNIT; IC3303)-continued**

Pin number	Port name	Description
79	STRS	Outputs the optional antenna tuner (AT-141) start control signal via J6703 (PA unit).
80	KEYS	Input port for the optional antenna tuner (AT-141E) key control signal via J6703 (PA unit).
89	EDT	I/O port for the serial data signal from/to the EEPROM (IC3301, pin 5).
90	ECK	Outputs clock signal for the EEPROM (IC3301, pin 6).
93	TEMP1	Input port for the temperature detection signal from the PA unit.
94	NSEN1	Input port for the SEND signal from the connected unit via AF/MOD connector (J9001, pin 5).
97	RFML1	Input port for the RF/ANTC meter's voltage from the meter amplifier (IC1201, pin 14).

**3-8-2 FRONT CPU PORT ALLOCATIONS  
(RC-25E DISPLAY-A UNIT; IC8201)**

Pin number	Port name	Description
17	DSEL	Outputs DISTRESS LED control signal.
21	FUNK	Input port for [FREQ/CH].
22	TXK	Input port for [TX TXF].
23	RXK	Input port for [RX CLAR].
24	FCHK	Input port for [ENT].
25	T0K	Input port for [0 DIM].
26	ENTK	Input port for [CE].
28	PWRK	Input port for [POWER].
31	PMUT	Input port for the phone plug insert detection signal.
32	FPTT	Input port for [PTT] switch of the connected microphone (J8701, pin 5).
33	AFGL	Input port for [VOL].
34	M1AD	Input port for the using microphone detection signal.
35	M2AD	Input port for the switch signal on the microphone.
36	M3AD	Input port for the microphone connecting detection.
41-46	CL1, RS, RD, WR, RES, CS	Output LCD drive signals.
48-55	DB7- DB0	Output LCD drive signals.
57	T9K	Input port for [9].
58	T8K	Input port for [8 PRN].
59	T7K	Input port for [7].
60	T6K	Input port for [6 RF-G].
61	T5K	Input port for [5 AGC <sup>x</sup> ].
62	T4K	Input port for [4 SP <sup>x</sup> ].
63	T3K	Input port for [3 SCAN].
64	T2K	Input port for [2 SQL].
65	T1K	Input port for [1 NB].
66	EMLK	Input port for [DSC].
67	SETK	Input port for [G].
68	MODK	Input port for [MODE SET].
69	TUNK	Input port for [TUNE THRU].
70	DALK	Input port for [CANCEL].
71	CSCK	Input port for [CALL].
72	DSTK	Input port for [DISTRESS].
74, 75	CHA, CHB	Input ports for [CH].
76, 77	GPA, GPB	Input ports for [GRP].

**3-8-3 OUTPUT EXPANDER IC (MAIN UNIT; IC3601)**

Pin number	Port name	Description
4	PST1	Outputs strobe signal for the DDS IC (PLL unit; IC5101, pin 91).
5	PST2	Outputs strobe signal for the PLL IC (PLL unit; IC5401, pin 13).
6	PST3	Outputs strobe signal for the DDS IC (PLL unit; IC5701, pin 41).
7	PST4	Outputs strobe signal for the DDS IC (PLL unit; IC5801, pin 41).
14	PST5	Outputs strobe signal for the DDS IC (PLL unit; IC5901, pin 41).

**3-8-4 OUTPUT EXPANDER IC (MAIN UNIT; IC3602)**

Pin number	Port name	Description
4	L0S	Outputs 0.5–1.999999 MHz low-pass filter control signal.
5	L1S	Outputs 2–2.999999 MHz low-pass filter control signal.
6	L2S	Outputs 3–4.999999 MHz low-pass filter control signal.
7	L3S	Outputs 5–6.999999 MHz low-pass filter control signal.
11	L7S	Outputs 20–30 MHz low-pass filter control signal.
12	L6S	Outputs 14–19.999999 MHz low-pass filter control signal.
13	L5S	Outputs 10–13.999999 MHz low-pass filter control signal.
14	L4S	Outputs 7–9.999999 MHz low-pass filter control signal.

**3-8-5 OUTPUT EXPANDER IC (IC3603)**

Pin number	Port name	Description
4	NMS	Outputs NBDP MOD control signal for the gate mod IC (IC2001, pin 10).
5	EMS	Outputs external MOD control signal for the gate mode IC (IC2001, pin 11).
6	MMS	Outputs microphone MOD control signal for the gate mode IC (IC2001, pin 9).
11	NMRS	Outputs NMEA/RS-232C switching signal.
13	AFMS	Outputs AF mute control signal.

**3-8-6 OUTPUT EXPANDER IC (IC3604)**

Pin number	Port name	Description
4	B0S	Outputs 0.5–1.999999 MHz bandpass filter control signal.
5	B1S	Outputs 2–2.999999 MHz bandpass filter control signal.
6	B2S	Outputs 3–4.999999 MHz bandpass filter control signal.
7	B3S	Outputs 5–6.999999 MHz bandpass filter control signal.
11	B7S	Outputs 18–23.999999 MHz bandpass filter control signal.
12	B6S	Outputs 14–17.999999 MHz bandpass filter control signal.
13	B5S	Outputs 10–13.999999 MHz bandpass filter control signal.
14	B4S	Outputs 7–9.999999 MHz bandpass filter control signal.

**3-8-7 OUTPUT EXPANDER IC (IC3605)**

Pin number	Port name	Description
4	B8S	Outputs 24–30 MHz bandpass filter control signal.
5	DBP1	Outputs bandpass filter control signal for DSC circuit (2.1875 MHz, 4.2075 MHz, 6.3120 MHz).
6	DBP2	Outputs bandpass filter control signal for the DSC circuit (8.4145 MHz).
7	DBP3	Outputs bandpass filter control signal for the DSC circuit (12.5770 MHz).
14	DBP4	Outputs bandpass filter control signal for the DSC circuit (16.8045 MHz).

**3-8-8 D/A CONVERTER IC (IC3606)**

Pin number	Port name	Description
5	POCV	Outputs transmit power control signal for the ALC amplifier (IC1201, pin 3) and RF amplifier (Q701).
6	AFG	Outputs the AF level control signal for the VCA amplifier (IC1603, pin 8).
11	FANS	Outputs the control signal for the cooling fan controller (PA unit; IC6501, Q6501).
13	TRXS	Outputs control signal for the TX/RX switching relay (FILTER unit; RL7301).

# SECTION 4 ADJUSTMENT PROCEDURES

## 4-1 PREPARATION

When adjusting IC-M801E, a JIG CABLE (see illustration as shown below) is required. Some adjustments must be performed on the "ADJUSTMENT MODE". Entering the "ADJUSTMENT MODE", see the next page.

### REQUIRED TEST EQUIPMENT

EQUIPMENT	GRADE AND RANGE	EQUIPMENT	GRADE AND RANGE
DC power supply (for 24 V version)	Output voltage : 24 V DC Current capacity : 30 A or more	Audio generator	Frequency range : 300–3000 Hz Measuring range : 1–500 mV
(for 12 V version)	Output voltage : 13.8 V DC Current capacity : 60 A or more	Attenuator	Power attenuation : 40 or 50 dB Capacity : 200 W or more
RF power meter (terminated type)	Measuring range : 1–200 W Frequency range : 0.5–30 MHz Impedance : 50 Ω SWR : Less than 1.2 : 1	Standard signal generator (SSG)	Frequency range : 0.1–30 MHz Output level : 0.1 μV to 32 mV (–127 to –17 dBm)
Frequency counter	Frequency range : 0.1–300 MHz Frequency accuracy : ±0.25 ppm or better Sensitivity : 100 mV or better	DC voltmeter	Input impedance : 50 kΩ/V DC or more
		Oscilloscope	Frequency range : DC to 100 MHz Measuring range : 0.01–10 V
DC ammeter	Measuring capability : 10 A/50 A	Digital multimeter	Input impedance : 10 MΩ/DC or more
RF voltmeter	Frequency range : 0.1–300 MHz Measuring range : 0.01–10 V	AC millivoltmeter	Measuring range : 1 mV to 10 V
		Electric load	Current capacity : 40 A or more

### CONNECTION

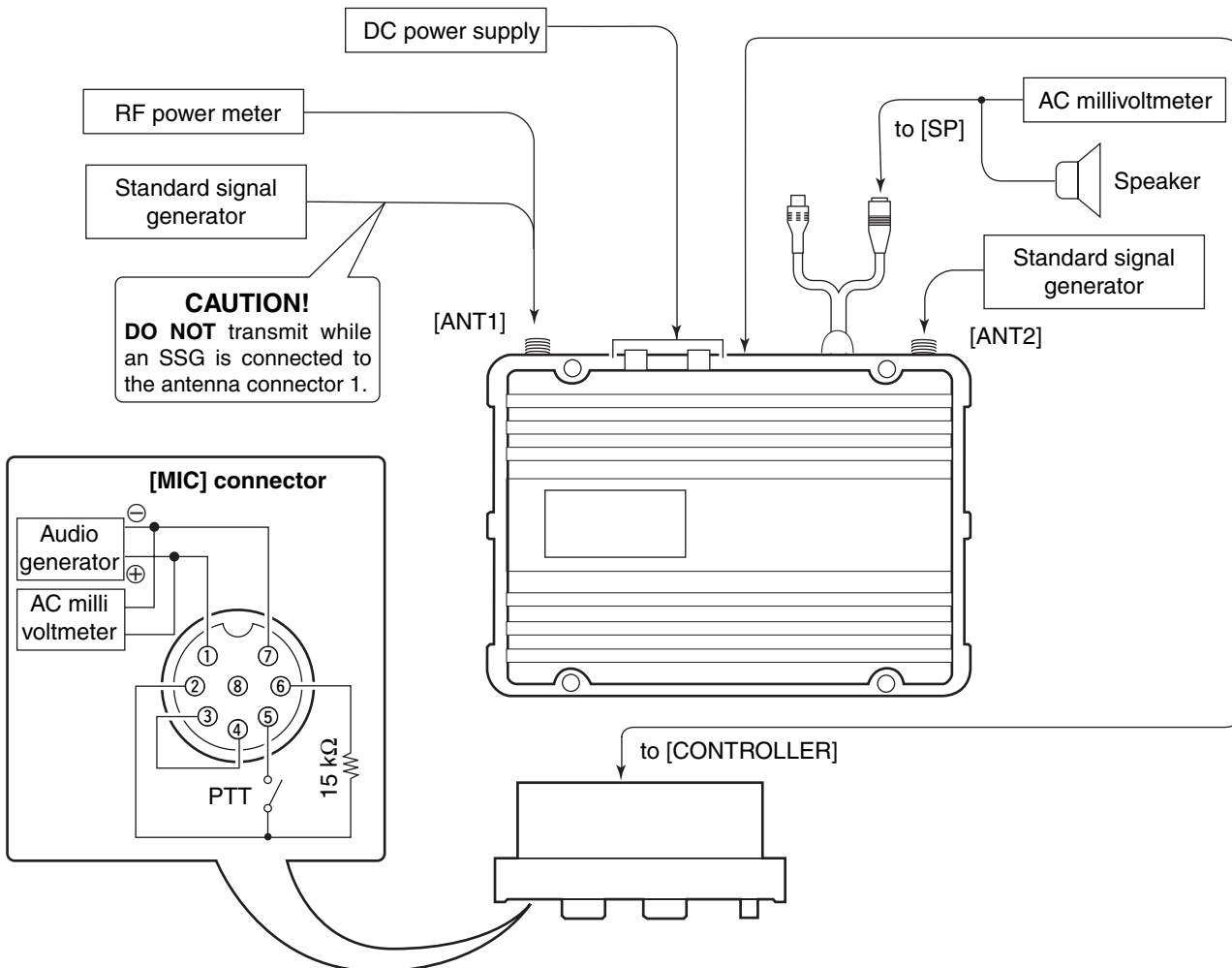

## ENTERING THE ADJUSTMENT MODE

- ① Turn the power OFF.
- ② Terminate the 15 kΩ resistor between pins 2 and 6 of [MIC] connector.
- ③ While pushing both [TX] and [RX], turn the power ON. (See the illustration as below)

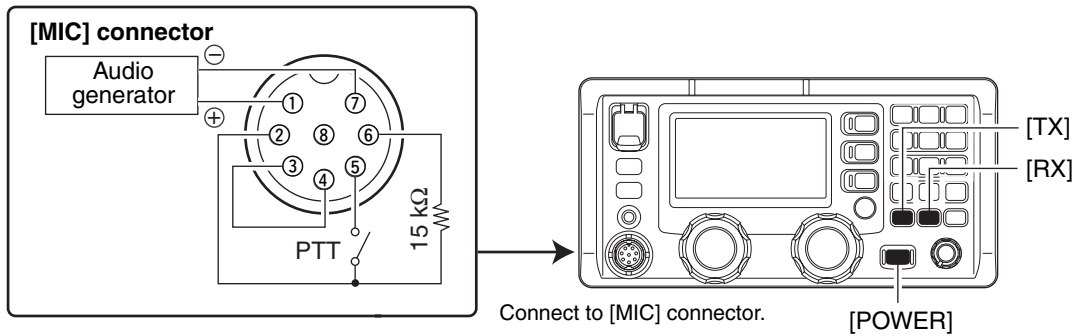

## OPERATING ON THE ADJUSTMENT MODE

- Enter the TX adjustment. : Push [1 NB]
- Enter the RX adjustment. : Push [2 SQL]
- Enter the DSC adjustment. : Push [3 SCAN]
- Move the next adjustment. : Push [0 DIM]
- Return to the previous adjustment. : Push [CE]

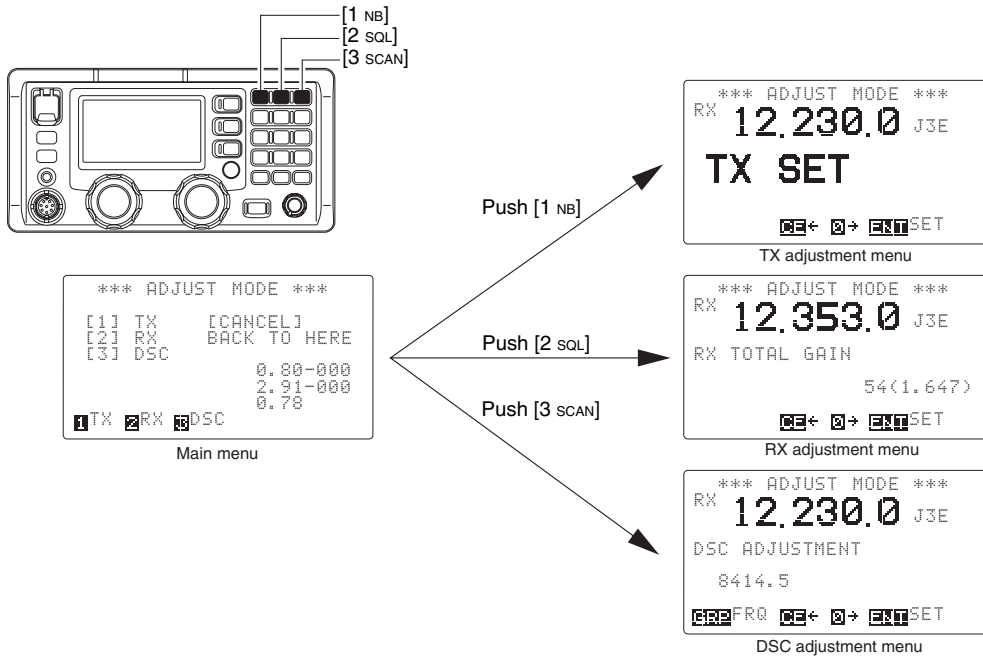

### TX ADJUSTMENT ITEM CHANGING

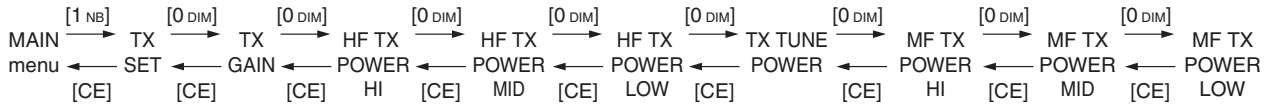

### RX ADJUSTMENT ITEM CHANGING



### DSC ADJUSTMENT ITEM CHANGING

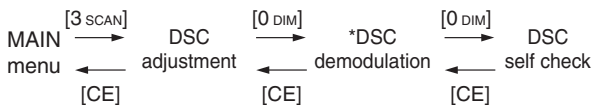

**\*NOTE: DO NOT** adjust "DSC DEMODULATION". Push [0 DIM] twice to skip "DSC DEMODULATION", after adjusting "DSC adjustment".

## 4-2 REGULATOR ADJUSTMENT

ADJUSTMENT	ADJUSTMENT CONDITION	MEASUREMENT		VALUE	ADJUSTMENT	
		UNIT	LOCATION		UNIT	ADJUST
OUTPUT VOLTAGE	1 <ul style="list-style-type: none"> <li>• Connect DC power supply to DC POWER TERMINALS.</li> <li>• Preset R415 (REG-DC unit) to max. clockwise.</li> </ul>	REG-DC	Connect a DC voltmeter between EP201 (+) and EP202 (-).	14.0 V	REG-DC	R415
LIMITER	1 <ul style="list-style-type: none"> <li>• Preset R420 (REG-DC unit) to max. counter clockwise.</li> <li>• Connect an electric load with 35 A load current between EP201 (+) and EP202 (-).</li> </ul>	REG-DC		0 V at 35 A current load	REG-DC	R420

### ■ REG-DC UNIT

• LOCATION (Top half)

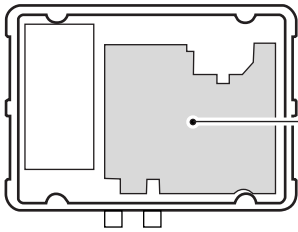
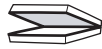

REG-DC UNIT

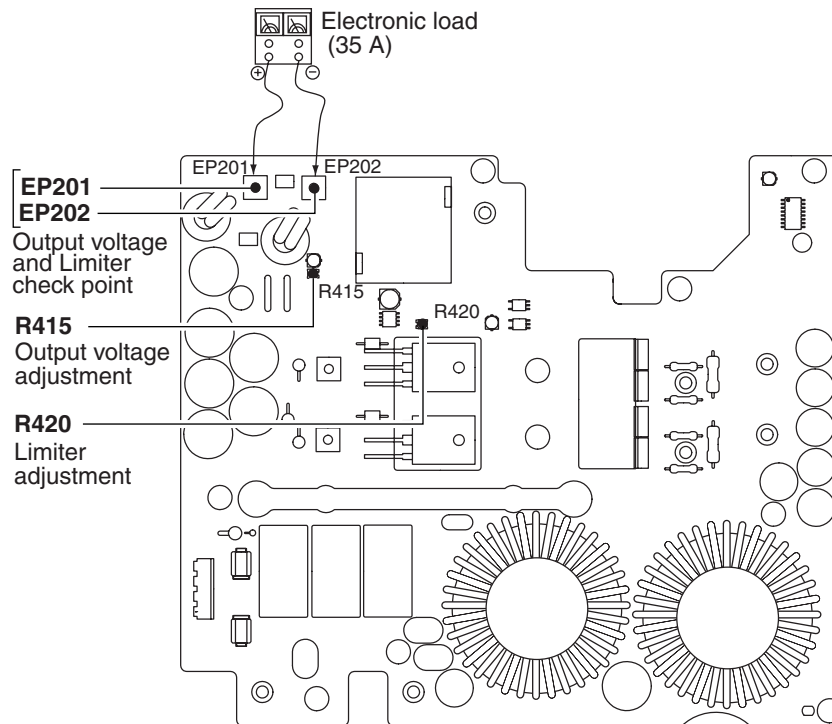



### 4-3 PLL ADJUSTMENT

ADJUSTMENT	ADJUSTMENT CONDITION	MEASUREMENT		VALUE	ADJUSTMENT	
		UNIT	LOCATION		UNIT	ADJUST
LPL LOCK VOLTAGE	1 Disassemble and turn over the PLL unit for the adjustment. When turn over the PLL unit, be care the cable connection from the other unit does not separate.					
	<ul style="list-style-type: none"> <li>Operating freq. : 0.5000 MHz</li> <li>Mode : J3E</li> <li>Receiving</li> </ul>	PLL	Connect a digital multi meter or oscilloscope to CP5301.	1.0 V	PLL	C5305
	2 <ul style="list-style-type: none"> <li>Operating freq. : 0.4999 MHz</li> <li>Receiving</li> </ul>			Less than 4.0 V		Verify
HPL LOCK VOLTAGE	1 <ul style="list-style-type: none"> <li>Operating freq. : 29.9999 MHz</li> <li>Mode : J3E</li> <li>Receiving</li> </ul>	PLL	Connect a digital multi meter or oscilloscope to CP5401.	4.2 V	PLL	C5521
	2 <ul style="list-style-type: none"> <li>Operating freq. : 0.0300 MHz</li> <li>Receiving</li> </ul>			More than 0.8 V		Verify
REFERENCE FREQUENCY	1 <ul style="list-style-type: none"> <li>Wait for 5 minute after power ON.</li> <li>Receiving</li> </ul>	PLL	Connect an RF voltmeter (50 Ω terminated) to P5201.	Maximum level	PLL	L5203, L5204
	2		Connect a frequency counter to P5201.	63.999990 MHz		X5251
After the adjustment, assemble the PLL unit and connect P5201 to J301 (MAIN unit).						

#### ■ PLL UNIT

• LOCATION (Bottom half)

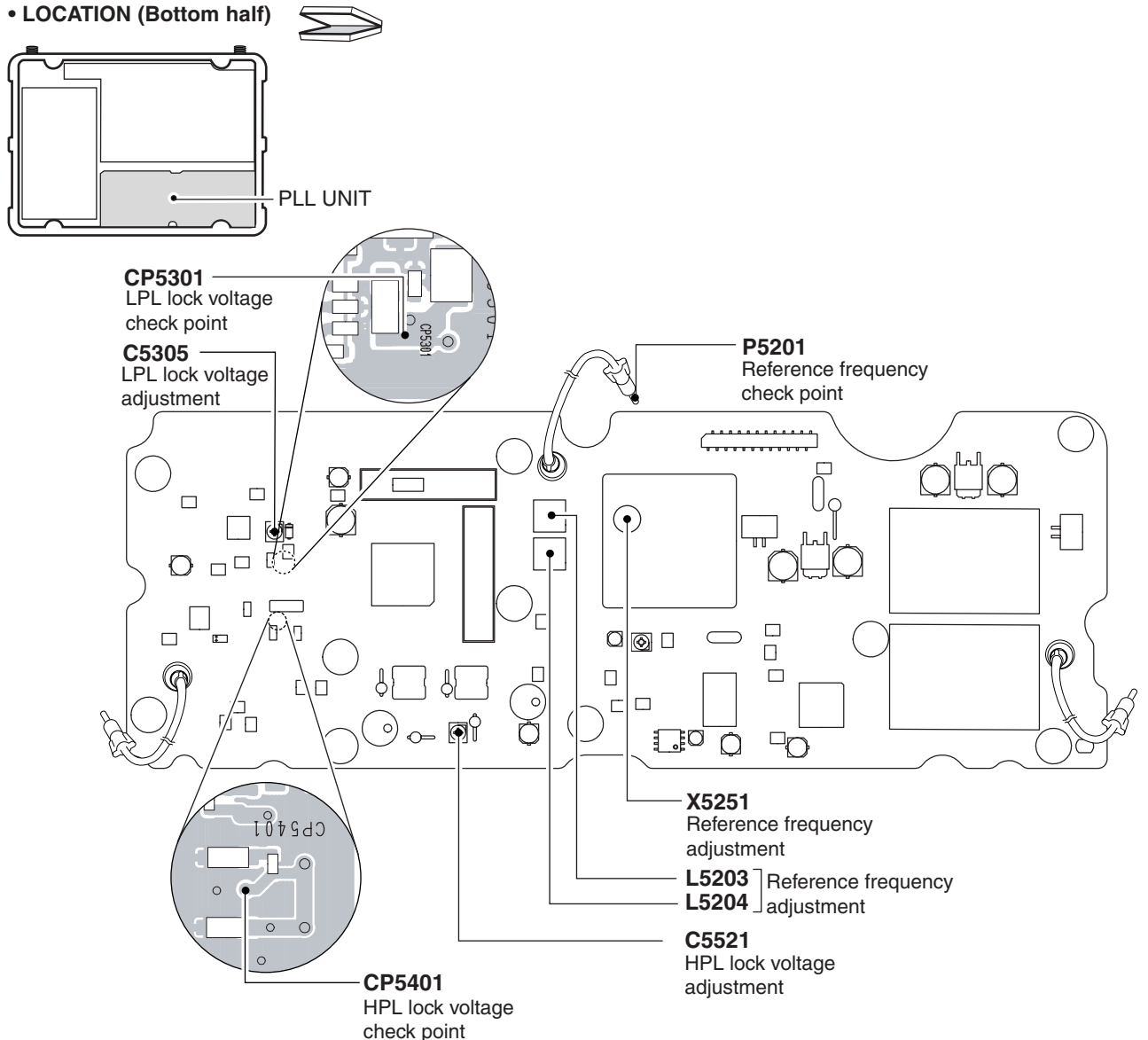

## 4-4 TRANSMITTER ADJUSTMENT

ADJUSTMENT	ADJUSTMENT CONDITION	MEASUREMENT		VALUE	ADJUSTMENT		
		UNIT	LOCATION		UNIT	ADJUST	
IDLING CURRENT (For drive FETs)  (For final transistors)	1	<ul style="list-style-type: none"> <li>Operating freq. : 12.2350 MHz</li> <li>Mode : J3E</li> <li>Apply no audio signal to [MIC] connector.</li> <li>Disconnect J6702 on the PA unit.</li> </ul>	PA	Connect a DC ammeter (10 A) between W4513 and EP6603.	2.0 A higher from the previous draining current of the adjustment.	PA	R6304
	2	<ul style="list-style-type: none"> <li>Preset R6304 and R6412 on the PA unit to max. counter clockwise.</li> <li>Connect a dummy load or RF power meter to [ANT1] connector.</li> <li>Transmitting</li> </ul>					700 mA higher from the previous draining current of the adjustment.
After the adjustment, connect J6702 to the PA unit.							
IC-APC	1	<ul style="list-style-type: none"> <li>Operating freq. : 12.2350 MHz</li> <li>Mode : J3E</li> <li>Connect an audio generator to [MIC] connector and set as;                             <ul style="list-style-type: none"> <li>Frequency : 1.5 kHz</li> <li>Level : 100 mV</li> </ul> </li> <li>Preset R6516 (PA unit) to center.</li> <li>Connect a wire between J1301 pin 15 (MAIN unit) and ground.</li> <li>Transmitting</li> </ul>	PA	Connect a DC ammeter (50 A) between W4513 and EP6603.	33.5 A	PA	R6516
	After the adjustment, disconnect a wire between J1301 (MAIN unit) and ground, and connect W4513 to EP6603 (PA unit).						
SWR DETECTOR	1	<ul style="list-style-type: none"> <li>Operating freq. : 22.00000 MHz</li> <li>Mode : J3E</li> <li>Connect a wire between CP7332 (Filter unit) and ground.</li> </ul>	[ANT1] connector	Connect an RF power meter to [ANT1] connector.	140 W	Audio generator	Output level
	2	<ul style="list-style-type: none"> <li>Connect an audio generator to [MIC] connector and set as;                             <ul style="list-style-type: none"> <li>Frequency : 1.5 kHz</li> </ul> </li> <li>Transmitting</li> </ul>		Connect a DC voltmeter to CP7331.	Minimum voltage	FILTER	C7275
After the adjustment, disconnect a wire between CP7332 (FILTER unit) and ground.							

### PA UNIT

#### • LOCATION (Top half)

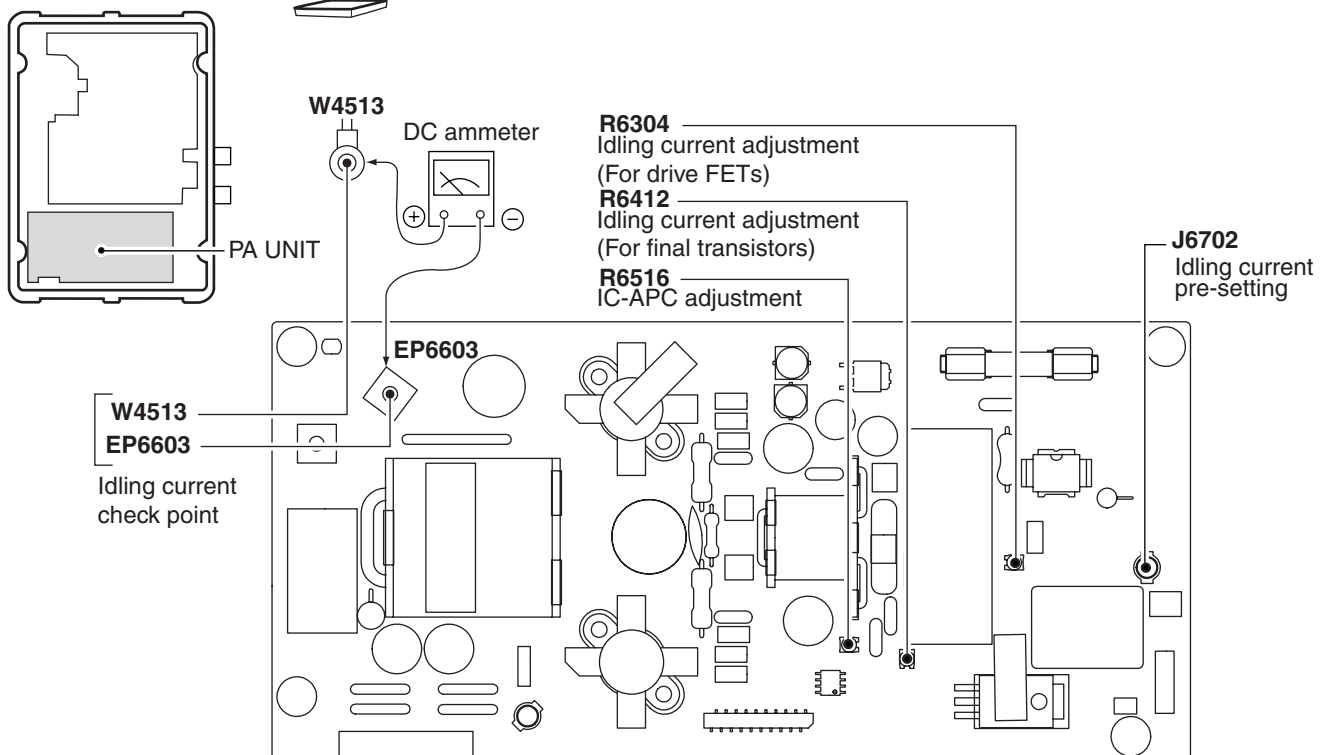

# MAIN AND FILTER UNITS

• LOCATION (Bottom half)

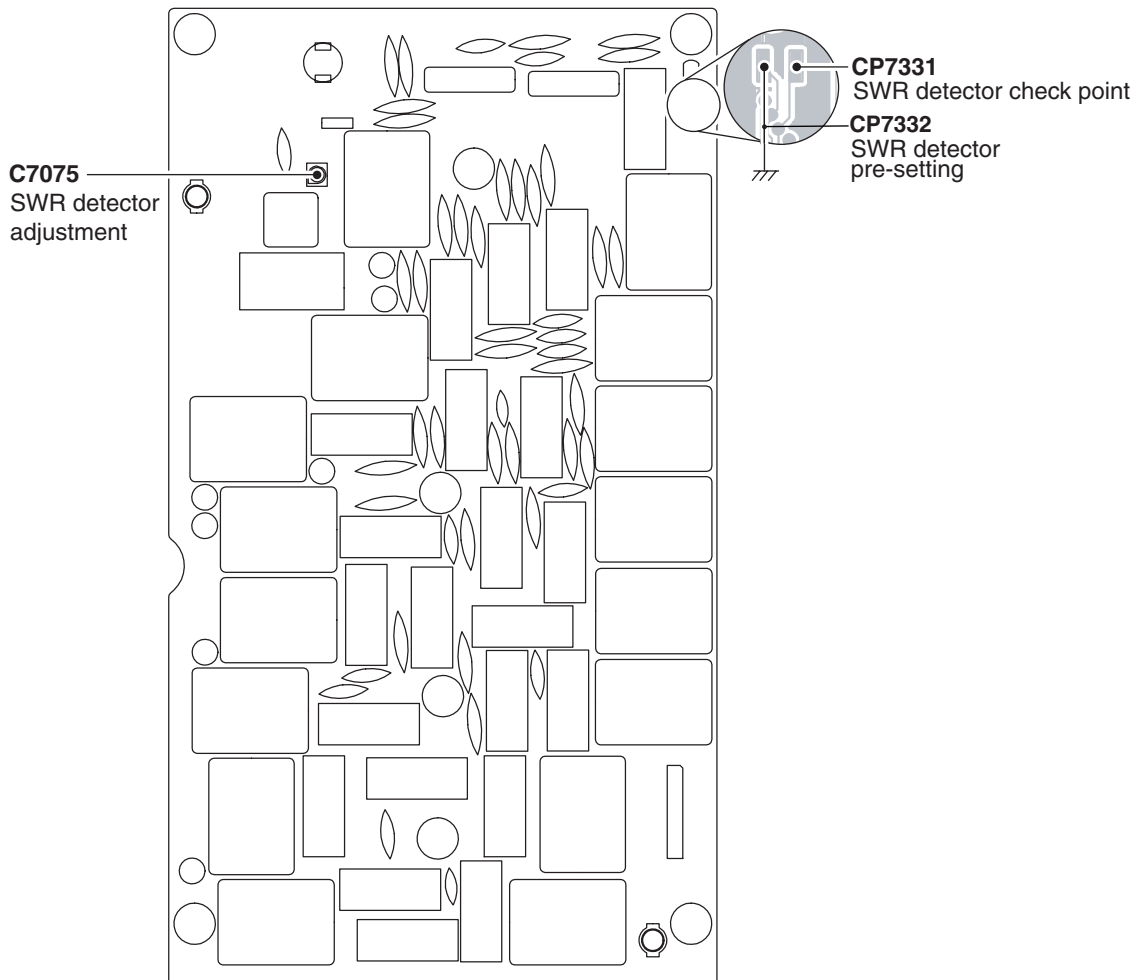
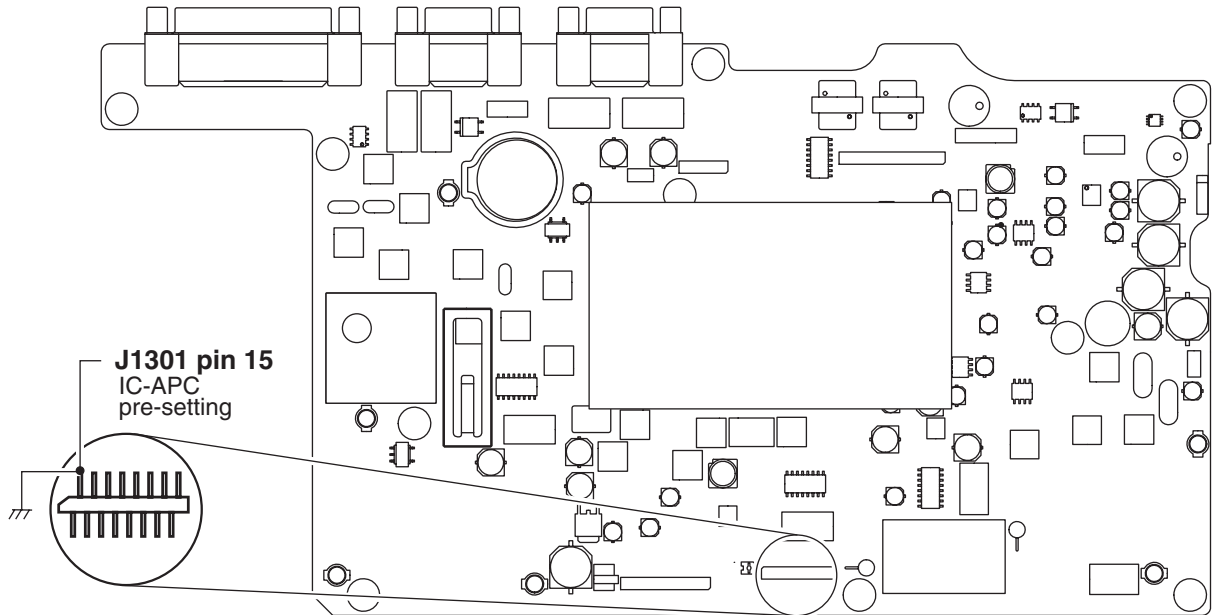
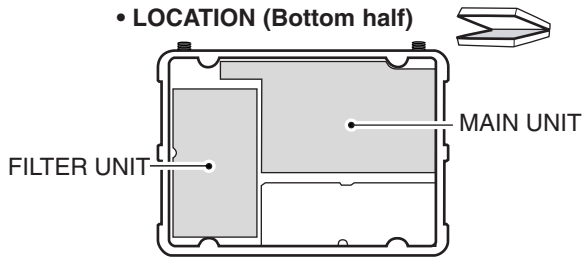

## 4-5 RECEIVER AND CPU ADJUSTMENT

ADJUSTMENT	ADJUSTMENT CONDITION	MEASUREMENT		VALUE	ADJUSTMENT	
		UNIT	LOCATION		UNIT	ADJUST
CPU CLOCK	1 <ul style="list-style-type: none"> <li>• Disconnect the DSP unit.</li> <li>• Receiving</li> </ul>	MAIN	Connect a frequency counter to CP3301.	14.7456 MHz	MAIN	C3313
NOISE NULL POINT	1 <ul style="list-style-type: none"> <li>• Operating freq. : 0.5000 MHz</li> <li>• Mode : H3E</li> <li>• Preset L402 and L405 as the illustration at right.</li> <li>• Preset L401, L403, L404 and L801 as the illustration at right.</li> <li>• Apply no signal to [ANT1] connector.</li> <li>• Receiving</li> </ul>	[SP]	Connect an AC millivolt meter to [SP] jack with a 4 Ω load.	Minimum audio output level	MAIN	L207
RECEIVER GAIN	1 <ul style="list-style-type: none"> <li>• Operating freq. : 12.2310 MHz</li> <li>• Mode : J3E</li> <li>• Connect an SSG to [ANT1] connector and set as;               <ul style="list-style-type: none"> <li>Frequency : 12.2310 MHz</li> <li>Level : 0.5 μV* (-113 dBm)</li> <li>Modulation : OFF</li> </ul> </li> <li>• Receiving</li> </ul>		Connect an AC millivolt meter to [SP] jack with a 4 Ω load.	Maximum audio output level	MAIN	Adjust in sequence L208, L209, L210, L301, L307, L302

\*The output level of the standard signal generator (SSG) is indicated as the SSG's open circuit.

### MAIN UNIT

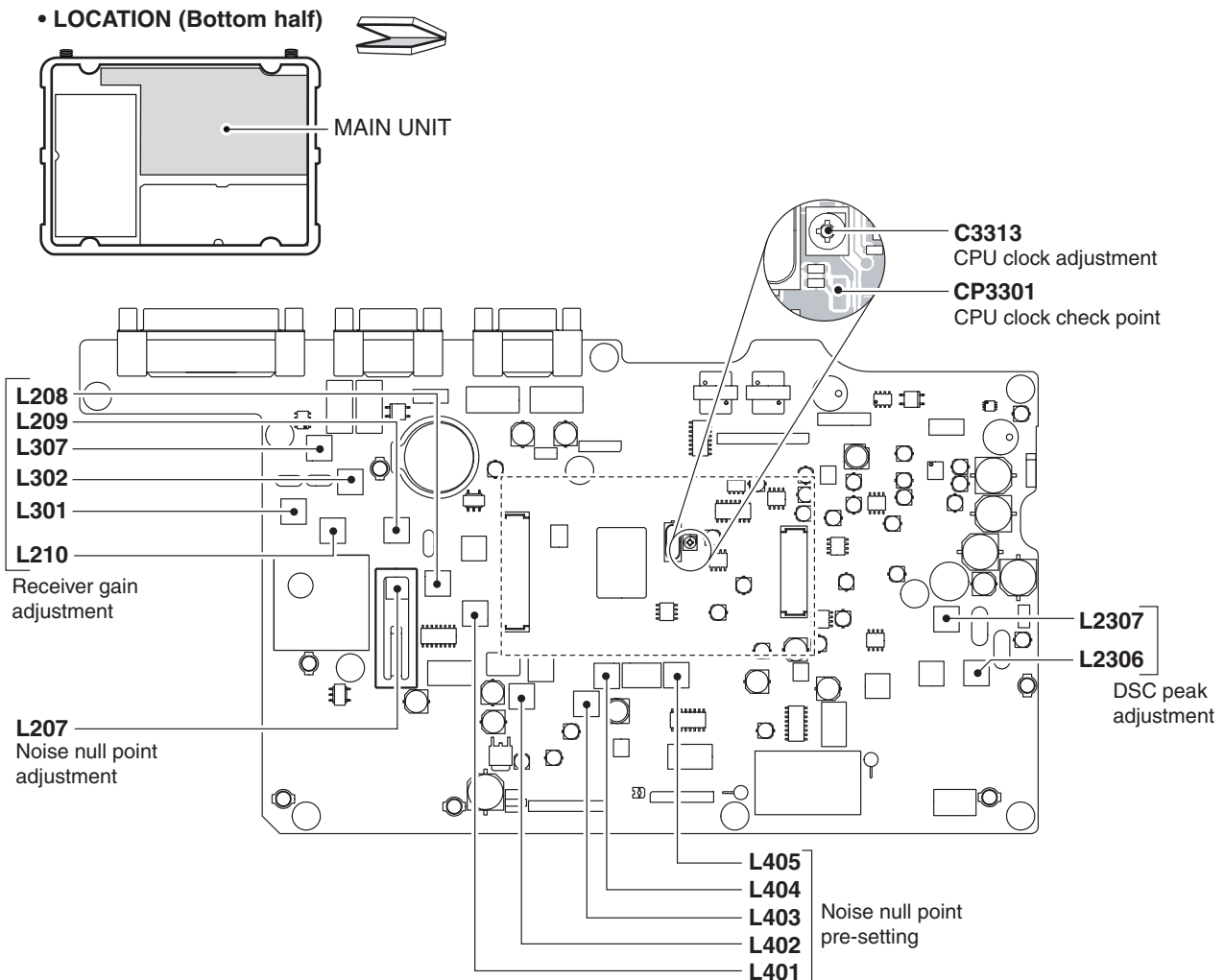

## 4-6 SOFTWARE ADJUSTMENT

ADJUSTMENT	ADJUSTMENT CONDITION	DISPLAY	OPERATION
TOTAL GAIN	1 <ul style="list-style-type: none"> <li>• Enter the adjustment mode.</li> <li>• Push [2 SQL] to enter the RX adjustment mode.</li> <li>• Connect an SSG to [ANT1] connector and set as;               <ul style="list-style-type: none"> <li>Frequency : 12.3540 MHz</li> <li>Level : 320 <math>\mu</math>V* (-57 dBm)</li> <li>Modulation : OFF</li> </ul> </li> <li>• Receiving</li> </ul>	<b>RX TOTAL GAIN</b>	Push [ENT].
S-METER	1 <ul style="list-style-type: none"> <li>• Apply no signal to [ANT1] connector.</li> <li>• Receiving</li> </ul>	<b>S LEVEL ZERO</b>	Push [ENT].
	2 <ul style="list-style-type: none"> <li>• Set an SSG as;               <ul style="list-style-type: none"> <li>Frequency : 12.3540 MHz</li> <li>Level : 7.1 mV* (-30 dBm)</li> <li>Modulation : OFF</li> </ul> </li> <li>• Receiving</li> </ul>	<b>S LEVEL 8</b>	Push [ENT].
DSC	1 <ul style="list-style-type: none"> <li>• Push [3 SCAN] to enter the DSC adjustment mode.</li> <li>• DSC frequency : 8.4145 MHz</li> <li>• Connect an AC millivolt meter to [SP] jack with a 4 <math>\Omega</math> load.</li> <li>• Connect an SSG to [ANT2] connector and set as;               <ul style="list-style-type: none"> <li>Frequency : 8.4145 MHz</li> <li>Level : 0.5 <math>\mu</math>V* (-113 dBm)</li> <li>Modulation : OFF</li> </ul> </li> <li>• Receiving</li> </ul>	<b>DSC ADJUSTMENT</b>	Set maximum AF output level by L2306, L2307.
	After adjustment, push [0 DIM] twice to select "DSC SELF CHECK" and disconnect an SSG from [ANT2].		
DSC SELF CHECK	1 <ul style="list-style-type: none"> <li>• DSC frequency : 8.4145 MHz</li> <li>• Connect an RF power meter to [ANT1] connector.</li> <li>• Transmitting</li> </ul>	<b>DSC SELF CHECK</b>	Push [ENT] to start "DSC SELF CHECK." <ul style="list-style-type: none"> <li>• When the DSC self check is succeeded, the transceiver displays main menu automatically.</li> <li>• When the DSC self check is failed, the transceiver displays "NG" message and emits error beep.</li> </ul>

\*The output level of the standard signal generator (SSG) is indicated as the SSG's open circuit.

#### 4-6 SOFTWARE ADJUSTMENT (continued)

ADJUSTMENT		ADJUSTMENT CONDITION	DISPLAY	OPERATION
ALC	1	<ul style="list-style-type: none"> <li>Enter the adjustment mode.</li> <li>Push [1 NB] to enter the TX adjustment mode.</li> <li>Connect an RF power meter to [ANT1] connector.</li> <li>Connect an audio generator to [MIC] connector and set as; Level : 1.5 kHz/4 mV</li> <li>Push [ENT], then the transceiver is transmitting.</li> </ul>	<b>TX GAIN</b>	Set maximum output power by L706, L302, L301.
(TOTAL GAIN)	2			Rotate [CH] to set the output power to 75 W. Then push [ENT].
HF POWER (HIGH)	1	<ul style="list-style-type: none"> <li>Connect an RF power meter to [ANT1] connector.</li> <li>Connect an audio generator to [MIC] connector and set as; Level : 1.5 kHz/100 mV</li> </ul>	<b>TX HF POWER HI</b>	Rotate [CH] to set the output power to 140 W. Then push [ENT].
(MIDDLE)	2		<b>TX HF POWER MID</b>	Rotate [CH] to set the output power to 100 W. Then push [ENT].
(LOW)	3		<b>TX HF POWER LOW</b>	Rotate [CH] to set the output power to 70 W. Then push [ENT].
TUNE POWER	1		<b>TX HF POWER TUNE</b>	Rotate [CH] to set the output power to 10 W. Then push [ENT].
MF POWER (HIGH)	1		<b>TX MF POWER HI</b>	Rotate [CH] to set the output power to 140 W. Then push [ENT].
(MIDDLE)	2		<b>TX MF POWER MID</b>	Rotate [CH] to set the output power to 100 W. Then push [ENT].
(LOW)	3		<b>TX MF POWER LOW</b>	Rotate [CH] to set the output power to 70 W. Then push [ENT].

## ■ MAIN UNIT

- LOCATION (Bottom half)

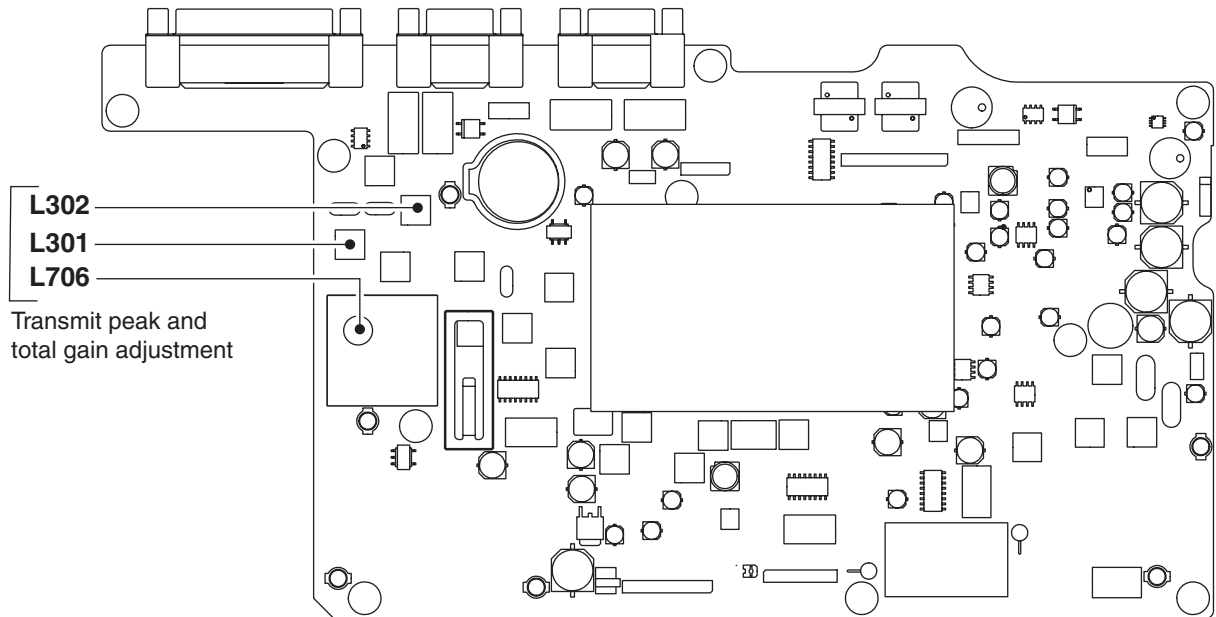
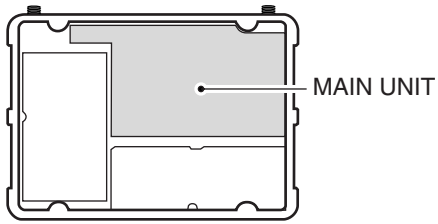















[MAIN UNIT]

Table with columns: REF NO., ORDER NO., DESCRIPTION, M., H/V LOCATION. Contains 1711 rows of equipment data.

[MAIN UNIT]

Table with columns: REF NO., ORDER NO., DESCRIPTION, M., H/V LOCATION. Contains 2246 rows of equipment data.

M.=Mounted side (T: Mounted on the Top side, B: Mounted on the Bottom side) S.=Surface mount







[PLL UNIT]

REF NO.	ORDER NO.	DESCRIPTION	M.	H/V LOCATION
R5605	7030003320	S.RES ERJ3GEYJ 101 V (100)	T	184.4/66.1
R5606	7030003380	S.RES ERJ3GEYJ 331 V (330)	T	184.4/67.5
R5607	7030003520	S.RES ERJ3GEYJ 472 V (4.7 k)	T	188.5/64.6
R5608	7030003520	S.RES ERJ3GEYJ 472 V (4.7 k)	T	188.5/70.6
R5609	7030003320	S.RES ERJ3GEYJ 101 V (100)	T	186.3/66.4
R5610	7030003360	S.RES ERJ3GEYJ 221 V (220)	T	189.8/69.6
R5611	7030003250	S.RES ERJ3GEYJ 270 V (27)	T	190.4/66.4
R5612	7030003380	S.RES ERJ3GEYJ 331 V (330)	T	183.6/63.9
R5613	7030003650	S.RES ERJ3GEYJ 563 V (56 k)	T	184.5/62.6
R5614	7030003350	S.RES ERJ3GEYJ 181 V (180)	T	180.5/66.9
R5701	7030007220	S.RES ERA3YED 202V (2 k)	T	58/52.9
R5702	7030007230	S.RES ERA3YED 102V (1 k)	T	59.3/52.9
R5703	7030007230	S.RES ERA3YED 102V (1 k)	T	60.6/52.9
R5704	7030007230	S.RES ERA3YED 102V (1 k)	T	61.9/52.9
R5705	7030007230	S.RES ERA3YED 102V (1 k)	T	63.2/52.9
R5706	7030007230	S.RES ERA3YED 102V (1 k)	T	64.5/52.9
R5707	7030007230	S.RES ERA3YED 102V (1 k)	T	65.8/52.9
R5708	7030007210	S.RES ERA3YEB 102V (1 k)	T	67.1/52.9
R5709	7030007210	S.RES ERA3YEB 102V (1 k)	T	68.4/54.5
R5710	7030007210	S.RES ERA3YEB 102V (1 k)	T	69.7/57.1
R5711	7030007220	S.RES ERA3YED 202V (2 k)	T	58/55.5
R5712	7030007220	S.RES ERA3YED 202V (2 k)	T	59.3/55.5
R5713	7030007220	S.RES ERA3YED 202V (2 k)	T	60.6/55.5
R5714	7030007220	S.RES ERA3YED 202V (2 k)	T	61.9/55.5
R5715	7030007220	S.RES ERA3YED 202V (2 k)	T	63.2/55.5
R5716	7030007220	S.RES ERA3YED 202V (2 k)	T	64.5/55.5
R5717	7030007220	S.RES ERA3YED 202V (2 k)	T	65.8/55.5
R5718	7030007200	S.RES ERA3YEB 202V (2 k)	T	67.1/55.5
R5719	7030007200	S.RES ERA3YEB 202V (2 k)	T	68.4/57.1
R5720	7030007200	S.RES ERA3YEB 202V (2 k)	T	72.5/61.5
R5721	7030003800	S.RES ERJ3GEYJ 105 V (1 M)	T	59/73.7
R5722	7030003320	S.RES ERJ3GEYJ 101 V (100)	T	60.9/75.1
R5781	7030003410	S.RES ERJ3GEYJ 561 V (560)	T	75.2/45.4
R5782	7030007860	S.RES ERJ3GEYJ 8R2V (8.2)	T	73.8/43.9
R5783	7030003410	S.RES ERJ3GEYJ 561 V (560)	T	75.4/46.7
R5799	7030003440	S.RES ERJ3GEYJ 102 V (1 k)	T	72.4/49.1
R5801	7030007220	S.RES ERA3YED 202V (2 k)	T	23.4/67.5
R5802	7030007230	S.RES ERA3YED 102V (1 k)	T	23.4/66.2
R5803	7030007230	S.RES ERA3YED 102V (1 k)	T	23.4/64.9
R5804	7030007230	S.RES ERA3YED 102V (1 k)	T	23.4/63.6
R5805	7030007230	S.RES ERA3YED 102V (1 k)	T	23.4/62.3
R5806	7030007230	S.RES ERA3YED 102V (1 k)	T	23.4/61
R5807	7030007230	S.RES ERA3YED 102V (1 k)	T	23.4/59.7
R5808	7030007210	S.RES ERA3YEB 102V (1 k)	T	23.4/58.4
R5809	7030007210	S.RES ERA3YEB 102V (1 k)	T	25/57.1
R5810	7030007210	S.RES ERA3YEB 102V (1 k)	T	27.6/55.8
R5811	7030007220	S.RES ERA3YED 202V (2 k)	T	26/67.5
R5812	7030007220	S.RES ERA3YED 202V (2 k)	T	26/66.2
R5813	7030007220	S.RES ERA3YED 202V (2 k)	T	26/64.9
R5814	7030007220	S.RES ERA3YED 202V (2 k)	T	26/63.6
R5815	7030007220	S.RES ERA3YED 202V (2 k)	T	26/62.3
R5816	7030007220	S.RES ERA3YED 202V (2 k)	T	26/61
R5817	7030007220	S.RES ERA3YED 202V (2 k)	T	26/59.7
R5818	7030007200	S.RES ERA3YEB 202V (2 k)	T	26/58.4
R5819	7030007200	S.RES ERA3YEB 202V (2 k)	T	27.6/57.1
R5820	7030007200	S.RES ERA3YEB 202V (2 k)	T	32/52.4
R5821	7030003800	S.RES ERJ3GEYJ 105 V (1 M)	T	44.2/66
R5822	7030003320	S.RES ERJ3GEYJ 101 V (100)	T	45.4/64.2
R5881	7030000220	S.RES MCR10EZHJ 47	T	12.9/68.1
R5882	7030003440	S.RES ERJ3GEYJ 102 V (1 k)	T	10.3/62.8
R5883	7030003450	S.RES ERJ3GEYJ 122 V (1.2 k)	T	13.2/63.3
R5885	7030003370	S.RES ERJ3GEYJ 271 V (270)	T	16.9/58.7
R5886	7030003440	S.RES ERJ3GEYJ 102 V (1 k)	T	19.3/59.2
R5887	7030003450	S.RES ERJ3GEYJ 122 V (1.2 k)	T	19.3/56.5
R5888	7030003280	S.RES ERJ3GEYJ 470 V (47)	T	20.2/63.9
R5889	7030003450	S.RES ERJ3GEYJ 122 V (1.2 k)	T	19.3/53.7
R5890	7030003410	S.RES ERJ3GEYJ 561 V (560)	T	16.9/63.9
R5891	7030003400	S.RES ERJ3GEYJ 471 V (470)	T	19.3/55.1
R5892	7030003260	S.RES ERJ3GEYJ 330 V (33)	T	6.9/60.3
R5901	7030007220	S.RES ERA3YED 202V (2 k)	T	23.5/41.3
R5902	7030007230	S.RES ERA3YED 102V (1 k)	T	23.5/40
R5903	7030007230	S.RES ERA3YED 102V (1 k)	T	23.5/38.7
R5904	7030007230	S.RES ERA3YED 102V (1 k)	T	23.5/37.4
R5905	7030007230	S.RES ERA3YED 102V (1 k)	T	23.5/36.1
R5906	7030007230	S.RES ERA3YED 102V (1 k)	T	23.5/34.8
R5907	7030007230	S.RES ERA3YED 102V (1 k)	T	23.5/33.5
R5908	7030007210	S.RES ERA3YEB 102V (1 k)	T	23.5/32.2
R5909	7030007210	S.RES ERA3YEB 102V (1 k)	T	25.1/30.9
R5910	7030007210	S.RES ERA3YEB 102V (1 k)	T	27.7/29.6
R5911	7030007220	S.RES ERA3YED 202V (2 k)	T	26.1/41.3
R5912	7030007220	S.RES ERA3YED 202V (2 k)	T	26.1/40
R5913	7030007220	S.RES ERA3YED 202V (2 k)	T	26.1/38.7
R5914	7030007220	S.RES ERA3YED 202V (2 k)	T	26.1/37.4
R5915	7030007220	S.RES ERA3YED 202V (2 k)	T	26.1/36.1
R5916	7030007220	S.RES ERA3YED 202V (2 k)	T	26.1/34.8
R5917	7030007220	S.RES ERA3YED 202V (2 k)	T	26.1/33.5
R5918	7030007200	S.RES ERA3YEB 202V (2 k)	T	26.1/32.2
R5919	7030007200	S.RES ERA3YEB 202V (2 k)	T	27.7/30.9
R5920	7030007200	S.RES ERA3YEB 202V (2 k)	T	32.4/26.1
R5921	7030003800	S.RES ERJ3GEYJ 105 V (1 M)	T	44.3/39.8
R5922	7030003320	S.RES ERJ3GEYJ 101 V (100)	T	45.5/38
R5981	7030003860	S.RES ERJ3GE JPW V	T	18/26.1

[PLL UNIT]

REF NO.	ORDER NO.	DESCRIPTION	M.	H/V LOCATION
R5982	7030003440	S.RES ERJ3GEYJ 102 V (1 k)	T	21.4/27.4
C5021	4510009330	S.ELE EEEHA1E470WP	T	58.2/33.6
C5022	4030011600	S.CER C1608 JB 1E 104K-T	T	64.1/25.9
C5023	4030011600	S.CER C1608 JB 1E 104K-T	T	69.7/29.5
C5024	4510009330	S.ELE EEEHA1E470WP	T	72.7/34.6
C5031	4510009330	S.ELE EEEHA1E470WP	T	23.5/15.3
C5032	4030011600	S.CER C1608 JB 1E 104K-T	T	27/10.2
C5033	4030011600	S.CER C1608 JB 1E 104K-T	T	35.2/10.7
C5034	4510009330	S.ELE EEEHA1E470WP	T	38.5/15.3
C5101	4030007060	S.CER C1608 CH 1H 270J-T	T	146.4/29.9
C5102	4030007010	S.CER C1608 CH 1H 100D-T	T	147.6/31.8
C5103	4030006960	S.CER C1608 CH 1H 050C-T	T	147.6/34.5
C5104	4030006880	S.CER C1608 JB 1H 472K-T	T	156.7/21.5
C5105	4030006880	S.CER C1608 JB 1H 102K-T	T	163.5/17.1
C5106	4030006880	S.CER C1608 JB 1H 472K-T	T	148.6/18.1
C5107	4030006880	S.CER C1608 JB 1H 472K-T	T	150.8/15.9
C5108	4030006880	S.CER C1608 JB 1H 472K-T	T	142.6/15.8
C5110	4510008970	S.ELE EEEHB1C100R	T	172.4/18.7
C5111	4030006880	S.CER C1608 JB 1H 472K-T	T	172.4/44.7
C5112	4030007090	S.CER C1608 CH 1H 470J-T	T	168.3/33.9
C5113	4030006880	S.CER C1608 JB 1H 472K-T	T	170.3/29.5
C5115	4030006880	S.CER C1608 JB 1H 472K-T	T	169/29.5
C5116	4510009330	S.ELE EEEHA1E470WP	T	171.9/24.3
C5117	4030006880	S.CER C1608 JB 1H 472K-T	T	168.6/38.1
C5118	4030006880	S.CER C1608 JB 1H 472K-T	T	169.9/38.1
C5120	4030006880	S.CER C1608 JB 1H 472K-T	T	161.1/26.3
C5121	4030006880	S.CER C1608 JB 1H 472K-T	T	159.3/26.3
C5122	4030006880	S.CER C1608 JB 1H 472K-T	T	156.9/26.4
C5123	4030006880	S.CER C1608 JB 1H 472K-T	T	151.9/26.2
C5124	4030006880	S.CER C1608 JB 1H 472K-T	T	150.3/46.2
C5125	4030011600	S.CER C1608 JB 1E 104K-T	T	148.2/43.2
C5126	4030011600	S.CER C1608 JB 1E 104K-T	T	149.1/29.4
C5201	4030006860	S.CER C1608 JB 1H 102K-T	T	127.3/39.2
C5202	4030006860	S.CER C1608 JB 1H 102K-T	T	123.6/42.8
C5203	4030006880	S.CER C1608 JB 1H 472K-T	T	120.7/36.5
C5204	4030006880	S.CER C1608 JB 1H 472K-T	T	120.7/38.7
C5205	4030007030	S.CER C1608 CH 1H 150J-T	T	124.9/36.5
C5206	4030006910	S.CER C1608 CH 1H 0R5C-T	T	119.9/28.2
C5207	4030007030	S.CER C1608 CH 1H 150J-T	T	119.9/23.5
C5251	4030007130	S.CER C1608 CH 1H 101J-T	T	98/66.3
C5253	4030006880	S.CER C1608 JB 1H 472K-T	T	82/70.7
C5254	4510008970	S.ELE EEEHB1C100R	T	84.4/74.6
C5281	4030006880	S.CER C1608 JB 1H 472K-T	T	103.1/56.1
C5282	4030006880	S.CER C1608 JB 1H 102K-T	T	101.8/58.9
C5283	4030006880	S.CER C1608 JB 1H 472K-T	T	111.4/63.8
C5301	4550000730	S.TAN TEESVA 0J 225M8R	T	187.7/33.3
C5302	4030006880	S.CER C1608 JB 1H 472K-T	T	172/34.6
C5303	4030009650	S.CER C1608 CH 1H 240J-T	T	184.2/23.5
C5304	4030011570	S.CER CM105 CH 101G 50AT	T	189.8/25.8
C5305	4610001850	S.TRI TZB4R200AB10R00	T	186.8/26.9
C5306	4030007150	S.CER C1608 CH 1H 151J-T	T	191.1/25.8
C5307	4030007150	S.CER C1608 CH 1H 151J-T	T	191.1/29.8
C5308	4030007150	S.CER C1608 CH 1H 151J-T	T	190.1/32
C5309	4030006880	S.CER C1608 JB 1H 472K-T	T	190.1/34.6
C5310	4030007010	S.CER C1608 CH 1H 100D-T	T	197.1/31.7
C5311	4030006880	S.CER C1608 JB 1H 472K-T	T	205.8/30.6
C5312	4510008970	S.ELE EEEHB1C100R	T	207.8/34.5
C5313	4030006880	S.CER C1608 JB 1H 472K-T	T	203.8/30.1
C5314	4030006880	S.CER C1608 JB 1H 472K-T	T	204.5/26.5
C5315	4030006880	S.CER C1608 JB 1H 472K-T	T	205.8/26.5
C5351	4030006880	S.CER C1608 JB 1H 472K-T	T	203.2/23.2
C5352	4030006880	S.CER C1608 JB 1H 472K-T	T	195/19.4
C5353	4030006880	S.CER C1608 JB 1H 472K-T	T	203/19.3
C5354	4030010000	S.CER C1608 CH 1H 510J-T	T	193.7/19.4
C5355	4030006960	S.CER C1608 CH 1H 050C-T	T	190.7/20.7
C5356	4030010000	S.CER C1608 CH 1H 510J-T	T	187.8/19.4
C5357	4030006880	S.CER C1608 JB 1H 472K-T	T	184.6/19.4
C5401	4030011600	S.CER C1608 JB 1E 104K-T	T	196.9/44
C5402	4030006860	S.CER C1608 JB 1H 102K-T	T	196.9/45.3
C5403	4030006900	S.CER C1608 JB 1H 103K-T	T	198.8/45.8
C5404	4030006880	S.CER C1608 JB 1H 472K-T	T	196.6/46.6
C5408	4550005980	S.TAN TEESVA 1A 475M8R	T	199/50.9
C5521	4610001830	S.TRI TZB4S100AB10R00	T	145.6/72
C5522	4030007130	S.CER C1608 CH 1H 101J-T	T	143.8/66.8
C5523	4030007010	S.CER C1608 CH 1H 100D-T	T	139.6/69.5
C5524	4030006880	S.CER C1608 JB 1H 472K-T	T	144.7/65.4
C5525	4030006870	S.CER C1608 JB 1H 222K-T	T	138/63.2
C5526	4030009510	S.CER C1608 CH 1H 010B-T	T	141.6/65.3
C5528	4030006860	S.CER C1608 JB 1H 102K-T	T	144.5/68.5
C5529	4030011340	S.CER C1608 CH 1H 471J-T	T	140.5/72.2
C5551	4550003980	S.TAN TEESVA 1A 475M8R	T	187.1/49.6
C5552	4550003250	S.TAN TEESVA 1V 474M8R	T	181.6/42.7
C5556	4030006860	S.CER C1608 JB 1H 102K-T	T	150.1/75
C5557	4030011600	S.CER C1608 JB 1E 104K-T	T	148.8/75
C5558	4510009370	ELE 16 ME 470 CZ	T	
C5560	4510009320	S.ELE EEEHB0J220R	T	129.7/72.2
C5561	403001			

[PLL UNIT]

REF NO.	ORDER NO.	DESCRIPTION	M.	H/V LOCATION
C5604	4030006880	S.CER C1608 JB 1H 472K-T	T	178.5/60.7
C5605	4030006880	S.CER C1608 JB 1H 472K-T	T	184.5/70.6
C5606	4030006860	S.CER C1608 JB 1H 102K-T	T	187.3/68.4
C5607	4030006880	S.CER C1608 JB 1H 472K-T	T	186.4/63.2
C5608	4030006880	S.CER C1608 JB 1H 472K-T	T	187.2/70.6
C5609	4030007090	S.CER C1608 CH 1H 470J-T	T	190.4/63.8
C5610	4030011280	S.CER C1608 CH 1H 271J-T	T	192.2/66.2
C5611	4030007090	S.CER C1608 CH 1H 470J-T	T	193.1/64
C5612	4030007060	S.CER C1608 CH 1H 270J-T	T	194.3/70.9
C5613	4030007020	S.CER C1608 CH 1H 120J-T	T	195.7/64
C5614	4030007060	S.CER C1608 CH 1H 270J-T	T	195.6/70.9
C5615	4030006980	S.CER C1608 CH 1H 070D-T	T	198/66.2
C5616	4030007040	S.CER C1608 CH 1H 180J-T	T	200/69.1
C5617	4030006860	S.CER C1608 JB 1H 102K-T	T	187.9/62.4
C5618	4030006880	S.CER C1608 JB 1H 472K-T	T	182.9/60.9
C5619	4030006930	S.CER C1608 CH 1H 020C-T	T	180.8/65
C5701	4030006880	S.CER C1608 JB 1H 472K-T	T	56.4/63.3
C5702	4030006880	S.CER C1608 JB 1H 472K-T	T	71.9/65.1
C5703	4030006880	S.CER C1608 JB 1H 472K-T	T	56.4/66.6
C5704	4030006880	S.CER C1608 JB 1H 472K-T	T	70.1/71.9
C5705	4030006880	S.CER C1608 JB 1H 472K-T	T	62.5/73.6
C5706	4030006880	S.CER C1608 JB 1H 472K-T	T	65.5/73.6
C5707	4030006880	S.CER C1608 JB 1H 472K-T	T	72.7/71.1
C5708	4510008970	S.ELE EEEHB1C100R	T	69.5/75.3
C5709	4030006880	S.CER C1608 JB 1H 472K-T	T	56.2/71.2
C5710	4030006860	S.CER C1608 JB 1H 102K-T	T	60.7/76.4
C5711	4030007010	S.CER C1608 CH 1H 100D-T	T	56.9/76.1
C5781	4030008770	S.CER C1608 JB 1H 562K-T	T	73.2/51.2
C5782	4030009490	S.CER C1608 JB 1H 821K-T	T	75.8/51.2
C5783	4030006900	S.CER C1608 JB 1H 103K-T	T	72.6/52.5
C5784	4030009980	S.CER C1608 JB 1H 152K-T	T	73.4/54.4
C5785	4030006900	S.CER C1608 JB 1H 103K-T	T	74.8/56.9
C5794	4030008920	S.CER C1608 JB 1H 473K-T	T	73.1/46.2
C5801	4030006880	S.CER C1608 JB 1H 472K-T	T	33.8/68.6
C5802	4030006880	S.CER C1608 JB 1H 472K-T	T	35.6/53.1
C5803	4030006880	S.CER C1608 JB 1H 472K-T	T	37.1/68.6
C5804	4030006880	S.CER C1608 JB 1H 472K-T	T	45/57.4
C5805	4030006880	S.CER C1608 JB 1H 472K-T	T	44.1/62.1
C5806	4030006880	S.CER C1608 JB 1H 472K-T	T	44.2/59.5
C5807	4030006880	S.CER C1608 JB 1H 472K-T	T	39.2/51.9
C5808	4510008970	S.ELE EEEHB1C100R	T	45.3/53.7
C5809	4030006880	S.CER C1608 JB 1H 472K-T	T	41.7/69.2
C5810	4030006860	S.CER C1608 JB 1H 102K-T	T	46.7/64.2
C5811	4030007010	S.CER C1608 CH 1H 100D-T	T	46.5/68.1
C5881	4030008920	S.CER C1608 JB 1H 473K-T	T	13.2/65.8
C5882	4030007020	S.CER C1608 CH 1H 120J-T	T	18.2/63.9
C5883	4030011600	S.CER C1608 JB 1E 104K-T	T	19.3/57.9
C5884	4030006880	S.CER C1608 JB 1H 472K-T	T	17.1/54.4
C5885	4030006980	S.CER C1608 CH 1H 070D-T	T	21.7/52.8
C5886	4030009500	S.CER C1608 CH 1H 0R5B-T	T	21.7/50.1
C5887	4030006980	S.CER C1608 CH 1H 070D-T	T	23.1/53.1
C5888	4030009510	S.CER C1608 CH 1H 010B-T	T	25.3/52.4
C5889	4030011770	S.CER C1608 CH 1H 060B-T	T	27.5/52
C5890	4030006880	S.CER C1608 JB 1H 472K-T	T	8.2/62
C5891	4030011600	S.CER C1608 JB 1E 104K-T	T	16.9/61.3
C5892	4030011600	S.CER C1608 JB 1E 104K-T	T	11/69.5
C5893	4030007150	S.CER C1608 CH 1H 151J-T	T	5.6/59.7
C5901	4030006880	S.CER C1608 JB 1H 472K-T	T	33.9/42.4
C5902	4030006880	S.CER C1608 JB 1H 472K-T	T	35.7/26.9
C5903	4030006880	S.CER C1608 JB 1H 472K-T	T	37.2/42.4
C5904	4030006880	S.CER C1608 JB 1H 472K-T	T	45/30.5
C5905	4030006880	S.CER C1608 JB 1H 472K-T	T	44.2/35.8
C5906	4030006880	S.CER C1608 JB 1H 472K-T	T	44.2/33.1
C5907	4030006880	S.CER C1608 JB 1H 472K-T	T	39.5/25.6
C5908	4510008970	S.ELE EEEHB1C100R	T	45.6/26.8
C5909	4030006880	S.CER C1608 JB 1H 472K-T	T	41.8/43
C5910	4030006860	S.CER C1608 JB 1H 102K-T	T	46.8/38
C5911	4030007010	S.CER C1608 CH 1H 100D-T	T	46.8/42.1
C5981	4030011600	S.CER C1608 JB 1E 104K-T	T	18.7/27.4
C5982	4030007020	S.CER C1608 CH 1H 120J-T	T	23.4/26.7
C5983	4030009520	S.CER C1608 CH 1H 020B-T	T	23.4/24
C5984	4030007050	S.CER C1608 CH 1H 220J-T	T	25.5/27.5
C5985	4030009530	S.CER C1608 CH 1H 030B-T	T	25.5/26.2
C5986	4030009990	S.CER C1608 CH 1H 200J-T	T	27.5/26.8
J5001	6510022581	S.CNR 24FMN-BMTTR-A-TBT (LF) (SN)	T	78/6.5
W5201	8970021851	WIR 62/99/300/C24/C31		
W5601	8970024241	WIR 62/99/140/C24/C31		
W5801	8970024690	WIR 62/99/180/C24/C31		

[PA UNIT]

REF NO.	ORDER NO.	DESCRIPTION	M.	H/V LOCATION
IC6501	1110005450	S.IC TS522IDT	T	112.5/15.7
IC6601	1180001251	S.IC TA7808F (TE16L,Q)	T	119.9/77.5
Q6101	1560001241	S.FET RD01MUS1-T113	T	169.9/48.1
Q6401	1590003040	TR SD1487		
Q6402	1590003040	TR SD1487		
Q6403	1540000501	TR 2SD1585-AZ K		
Q6601	1510001040	S.TR 2SA1037AKT146S	T	143.8/68.6
Q6602	1590000680	S.TR DTC114EUA T106	T	139.5/72.7
Q6701	1590000680	S.TR DTC114EUA T106	T	151.3/27.2
Q6801	1590003050	S.FET PD55003	T	158/58
D6701	1160000140	S.DIO DAP222 TL	T	151.5/29.9
L6101	6200003840	S.COL MLF2012D R22K-T	T	178.5/45.5
L6102	6180000990	COL LAL 04NA 101K		
L6202	6180001240	COL LAL 04NA 820K		
L6204	2040000490	COL EXC-ELDR25C		
L6301	6140003720	COL LR-416		
L6303	2040000490	COL EXC-ELDR25C		
L6401	2040000490	COL EXC-ELDR25C		
L6402	2040000490	COL EXC-ELDR25C		
L6403	2040000490	COL EXC-ELDR25C		
L6404	6140003590	COL LR-400		
L6405	6140003350	COL LR-376		
L6406	6190001710	COL SK-10M-15X2Y		
L6407	2040000490	COL EXC-ELDR25C		
L6408	6110001730	COL LA-262		
L6501	6200003261	S.COL NLV32T-101J	T	101/13.5
L6701	6200003590	S.COL EXCCL3225U1	T	113.2/6.5
L6702	6200002041	S.COL NLV25T-101J	T	85/9.2
L6703	6200003241	S.COL NLV32T-221J	T	177.7/24.9
L6704	6200003241	S.COL NLV32T-221J	T	180.7/24.9
L6705	6200008820	S.COL HF70ACC 635050-T	T	180/31.6
L6706	6200003241	S.COL NLV32T-221J	T	171.1/15.6
L6707	6200003950	S.COL HF50ACC 322513-T	T	88.3/13.3
L6708	6200003950	S.COL HF50ACC 322513-T	T	80.3/6.3
R6101	7030003270	S.RES ERJ3GEYJ 390 V (39)	T	178.7/42.5
R6102	7030003350	S.RES ERJ3GEYJ 181 V (180)	T	180.6/41.8
R6103	7030003350	S.RES ERJ3GEYJ 181 V (180)	T	180.6/43.3
R6104	7030003300	S.RES ERJ3GEYJ 680 V (68)	T	174.6/47.1
R6105	7030003480	S.RES ERJ3GEYJ 222 V (2.2 k)	T	176.4/47.6
R6106	7030003520	S.RES ERJ3GEYJ 472 V (4.7 k)	T	174.6/49.7
R6107	7030003420	S.RES ERJ3GEYJ 681 V (680)	T	173.3/49.7
R6109	7030003400	S.RES ERJ3GEYJ 471 V (470)	T	172.4/51.6
R6110	7030000210	S.RES MCR10EZHZ 39	T	171.8/54.5
R6111	7030000210	S.RES MCR10EZHZ 39	T	171.3/56.3
R6112	7030000210	S.RES MCR10EZHZ 39	T	171.2/58
R6201	7030000250	S.RES MCR10EZHZ 82	T	164.7/50.6
R6202	7030003510	S.RES ERJ3GEYJ 392 V (3.9 k)	T	164.2/46.5
R6203	7030003520	S.RES ERJ3GEYJ 472 V (4.7 k)	T	165/48.4
R6204	7030010800	S.RES ERJ1TYJ 2R7U (2.7)	T	153.7/45.1
R6206	7030003340	S.RES MCR10EZHZ 470	T	152.7/71.5
R6301	7030000260	S.RES MCR10EZHZ 100	T	146.2/48.4
R6302	7030003480	S.RES ERJ3GEYJ 222 V (2.2 k)	T	146.7/44.5
R6303	7030003450	S.RES ERJ3GEYJ 122 V (1.2 k)	T	146.7/42.5
R6304	7310005080	S.TRI RH03ADCN3X (3.3 k)	T	149.5/40
R6401	7030010260	S.RES ERJ1TYJ 3R3 U	T	92.5/17.5
R6402	7030010260	S.RES ERJ1TYJ 3R3 U	T	92.5/21.5
R6403	7030010260	S.RES ERJ1TYJ 3R3 U	T	93/25.5
R6404	7030010260	S.RES ERJ1TYJ 3R3 U	T	92.5/72.5
R6405	7030010260	S.RES ERJ1TYJ 3R3 U	T	92.5/68.5
R6406	7030010260	S.RES ERJ1TYJ 3R3 U	T	92.9/64.5
R6407	7030001010	S.RES MCR50JZH 10	T	82.8/31.5
R6408	7030001010	S.RES MCR50JZH 10	T	82.7/56.9
R6409	7070000371	RES ERX2SJ 2R2 (2.2)		
R6410	7070000371	RES ERX2SJ 2R2 (2.2)		
R6411	7070000521	RES ERX3SJ 2R2 (2.2)		
R6412	7310005140	S.TRI RH03ADCJ3X (2.2 k)	T	127.9/20.6
R6413	7030000300	S.RES MCR10EZHZ 220	T	132.8/19
R6502	7030005981	S.RES ERA3YED 333V (33 k)	T	119.7/13.2
R6503	7030005981	S.RES ERA3YED 333V (33 k)	T	118.7/16.7
R6504	7030005971	S.RES ERA3YKD 683V (68 k)	T	120.5/19.7
R6505	7030005971	S.RES ERA3YKD 683V (68 k)	T	117.5/18.2
R6507	7030003840	S.RES ERJ3GEYJ 225 V (2.2 M)	T	116.7/13
R6509	7030003320	S.RES ERJ3GEYJ 101 V (100)	T	114.5/12.2
R6513	7030003740	S.RES ERJ3GEYJ 334 V (330 k)	T	107.7/15.6
R6515	7030003520	S.RES ERJ3GEYJ 472 V (4.7 k)	T	103.9/13.9
R6516	7310005020	S.TRI RH03ADC14X (10 k)	T	116.2/23.4
R6518	7030003680	S.RES ERJ3GEYJ 104 V (100 k)	T	103/18.5
R6602	7030003520	S.RES ERJ3GEYJ 472 V (4.7 k)	T	140.6/70.8
R6603	7030003520	S.RES ERJ3GEYJ 472 V (4.7 k)	T	140.5/68.6
R6604	7030003580	S.RES ERJ3GEYJ 153 V (15 k)	T	137.3/71.8
R6651	7120000510	RES LR20DT10 5LO		
R6652	7120000510	RES LR20DT10 5LO		
R6653	7120000510	RES LR20DT10 5LO		
R6654	7120000510	RES LR20DT10 5LO		

M.=Mounted side (T: Mounted on the Top side, B: Mounted on the Bottom side)

S.=Surface mount

[PA UNIT]

REF NO.	ORDER NO.	DESCRIPTION	M.	H/V LOCATION
R6702	7030003520	S.RES ERJ3GEYJ 472 V (4.7 k)	T	61.7/7.7
R6704	7030003480	S.RES ERJ3GEYJ 222 V (2.2 k)	T	64.5/7
R6801	7030003410	S.RES ERJ3GEYJ 561 V (560)	T	156.2/67.5
R6802	7030004050	S.RES ERJ3GEYJ 1R0 V (1)	T	167.2/57.5
C6101	4030007120	S.CER C1608 CH 1H 820J-T	T	180.6/44.6
C6102	4030007120	S.CER C1608 CH 1H 820J-T	T	180.6/46.4
C6103	4030011600	S.CER C1608 JB 1E 104K-T	T	176.4/46.3
C6104	4030011600	S.CER C1608 JB 1E 104K-T	T	176.4/48.9
C6105	4030011600	S.CER C1608 JB 1E 104K-T	T	173.3/47.1
C6106	4030011600	S.CER C1608 JB 1E 104K-T	T	176.4/50.4
C6108	4030011600	S.CER C1608 JB 1E 104K-T	T	166.4/46.4
C6109	4030005110	S.CER C2012 JB 1E 473K-T	T	175.6/53
C6201	4030011600	S.CER C1608 JB 1E 104K-T	T	167/50.1
C6202	4030011600	S.CER C1608 JB 1E 104K-T	T	162.9/47.6
C6203	4030004750	S.CER C2012 JB 1H 103K-T	T	158.5/47
C6205	4030008700	S.CER GRM21BB11H473KA01L	T	149.7/48
C6206	4030008700	S.CER GRM21BB11H473KA01L	T	145.5/74.2
C6301	4030008960	S.CER C2012 JB 1C 104K-T	T	147.2/52.7
C6302	4030011600	S.CER C1608 JB 1E 104K-T	T	146.7/45.5
C6303	4510009370	ELE 16 ME 470 CZ		
C6305	4030011600	S.CER C1608 JB 1E 104K-T	T	110.3/60.2
C6306	4510006640	ELE 16 ME 1000 CZ		
C6307	4320001210	S.MIC UC552H 6800J-T	T	123.2/42.7
C6308	4030011790	S.CER GRM55RF52A684ZD01L	T	123.4/57.1
C6401	4030011760	S.CER GRM55R1X2D682JV01L	T	93/33.5
C6403	4030011760	S.CER GRM55R1X2D682JV01L	T	93/56.5
C6408	4030018370	S.CER ERF22X 6C1H 102J D01L	T	63.2/44.9
C6409	4030018370	S.CER ERF22X 6C1H 102J D01L	T	66.5/44.9
C6410	4030018230	S.CER ERF22X 6C2D 221JD	T	71.5/44.9
C6412	4510006640	ELE 16 ME 1000 CZ		
C6413	4510006640	ELE 16 ME 1000 CZ		
C6414	4030004740	S.CER C2012 JB 1H 472K-T	T	3.6/19
C6415	4030011790	S.CER GRM55RF52A684ZD01L	T	16.7/21.3
C6416	4030008920	S.CER C1608 JB 1H 473K-T	T	125/24.5
C6417	4510006640	ELE 16 ME 1000 CZ		
C6418	4030006880	S.CER C1608 JB 1H 472K-T	T	125/23.2
C6419	4030006880	S.CER C1608 JB 1H 472K-T	T	131.2/12
C6424	4030018370	S.CER ERF22X 6C1H 102J D01L	T	93.4/45
C6427	4030011600	S.CER C1608 JB 1E 104K-T	T	149/24.5
C6428	4030011600	S.CER C1608 JB 1E 104K-T	T	83.7/81.3
C6432	4030011740	S.CER GRM32N2C2H201JV01L	T	60.9/13.3
C6433	4030011740	S.CER GRM32N2C2H201JV01L	T	59.2/78.8
C6501	4030007130	S.CER C1608 CH 1H 101J-T	T	116.7/16
C6503	4030011600	S.CER C1608 JB 1E 104K-T	T	111.2/12.2
C6602	4030006880	S.CER C1608 JB 1H 472K-T	T	139.1/68.6
C6603	4510009370	ELE 16 ME 470 CZ		
C6604	4510009330	S.ELE EEEHA1E470WP	T	104.5/72.5
C6605	4030011600	S.CER C1608 JB 1E 104K-T	T	109.7/76
C6606	4030011600	S.CER C1608 JB 1E 104K-T	T	109.7/79
C6607	4510009330	S.ELE EEEHA1E470WP	T	104.7/80.2
C6608	4030008700	S.CER GRM21BB11H473KA01L	T	55.1/6.7
C6609	4510009390	ELE 16 ME 2200 CZ		
C6610	4030017320	S.CER GRM21BB11H104KA11L	T	7.8/77.8
C6611	4030004740	S.CER C2012 JB 1H 472K-T	T	7.8/75.5
C6612	4030004720	S.CER C2012 JB 1H 102K-T	T	10.5/79.2
C6701	4030008920	S.CER C1608 JB 1H 473K-T	T	149.1/30.6
C6702	4030008920	S.CER C1608 JB 1H 473K-T	T	59.8/8.4
C6703	4030008920	S.CER C1608 JB 1H 473K-T	T	64.5/5.5
C6704	4030006880	S.CER C1608 JB 1H 472K-T	T	85.6/11.2
C6705	4030006880	S.CER C1608 JB 1H 472K-T	T	110.2/6.5
C6706	4030006880	S.CER C1608 JB 1H 472K-T	T	165.5/6.1
C6712	4030006880	S.CER C1608 JB 1H 472K-T	T	163.5/6.7
C6713	4030006880	S.CER C1608 JB 1H 472K-T	T	167.3/6.8
C6714	4030006880	S.CER C1608 JB 1H 472K-T	T	163.5/5.4
C6715	4030006880	S.CER C1608 JB 1H 472K-T	T	168.2/8.1
C6801	4030011600	S.CER C1608 JB 1E 104K-T	T	159/67.5
RL6701	6330001470	RLY AJS1311		
J6301	6510021531	CNR IMSA-9230B-1-04Z024-PT1		
J6302	6510021531	CNR IMSA-9230B-1-04Z024-PT1		
J6401	6510007020	CNR TMP-J01X-V6		
J6411	6510021391	CNR IMSA-9230B-1-03Z024-PT1		
J6412	6510021391	CNR IMSA-9230B-1-03Z024-PT1		
J6701	6510022541	S.CNR 20FMN-BMTTR-A-TBT (LF)	T	98/8.1
J6702	6510007020	CNR TMP-J01X-V6		
J6703	6510003400	CNR B04B-EH-S		
F6701	5210000061	FUS FGB 5A PBF (FGB0 125V)		
F6702	5220000230	HOL S-N5054		
F6703	5220000230	HOL S-N5054		
S6701	6910011800	TML OHD3-130M		
W6401	9054500690	WIR 76/98/020/X98/X98		
W6402	9054500690	WIR 76/98/020/X98/X98		

[PA UNIT]

REF NO.	ORDER NO.	DESCRIPTION	M.	H/V LOCATION
W6601	9062700030	WIR 77/98/040/X98/X98		
EP6601	6910000630	BEA FSRH070140RN000B		
EP6602	6510018330	TER F4053A		
EP6603	6510018330	TER F4053A		
EP6701	6910012350	S.BEA MMZ1608Y 102BT	T	95.6/12
EP6702	6910012350	S.BEA MMZ1608Y 102BT	T	94.9/13.3
EP6703	6910012350	S.BEA MMZ1608Y 102BT	T	97.6/13.5
EP6704	6910012350	S.BEA MMZ1608Y 102BT	T	84.7/7.3
EP6705	6910012350	S.BEA MMZ1608Y 102BT	T	103.3/16.4
EP6706	6910012350	S.BEA MMZ1608Y 102BT	T	162.9/9.8
EP6707	6910012350	S.BEA MMZ1608Y 102BT	T	165.6/10.1
EP6708	6910012350	S.BEA MMZ1608Y 102BT	T	164.3/9.8
EP6709	6910012350	S.BEA MMZ1608Y 102BT	T	86.6/5.5
EP6710	6910012350	S.BEA MMZ1608Y 102BT	T	166.9/10.1

[DRIVER BOARD]

REF NO.	ORDER NO.	DESCRIPTION	M.	H/V LOCATION
Q6851	1590003060	S.FET PD55015	T	9.7/20
R6851	7030010520	S.RES ERJ1TYJ 101U (100)	T	8.2/13.1
R6852	7030000020	S.RES MCR10EZJH 1	T	1.9/15.4
C6851	4030004750	S.CER C2012 JB 1H 103K-T	T	14.1/14.1

[VARISTOR-1 BOARD]

REF NO.	ORDER NO.	DESCRIPTION	M.	H/V LOCATION
D6431	1790001760	S.VSR MA30-(TX)	T	3.4/13.5
C6431	4030008920	S.CER C1608 JB 1H 473K-T	T	3.7/11.7

[VRISTOR-2 BOARD]

REF NO.	ORDER NO.	DESCRIPTION	M.	H/V LOCATION
D6432	1790001760	S.VSR MA30-(TX)	T	3.7/13.6
C6432	4030008920	S.CER C1608 JB 1H 473K-T	T	3.8/11.7

M.=Mounted side (T: Mounted on the Top side, B: Mounted on the Bottom side)  
S.=Surface mount

[FILTER UNIT]

REF NO.	ORDER NO.	DESCRIPTION	M.	H/V LOCATION
Q7301	1590000680	S.TR DTC114EUA T106	B	139.2/88.4
D7271	1750000191	S.DIO 1SS322 (TE85R, F)	B	161.2/81.9
D7272	1750000191	S.DIO 1SS322 (TE85R, F)	B	161.2/85.5
D7301	1750000550	S.DIO 1SS355 TE-17	B	136.2/92.4
L7031	6200002041	S.COL NLV25T-101J	B	156.5/59.6
L7035	6200002041	S.COL NLV25T-101J	B	148.5/4.5
L7036	6140002240	COL LR-236 (T68-2)		
L7037	6140001990	COL LR-226 (T68-2)		
L7038	6140002000	COL LR-227 (T68-2)		
L7061	6200002041	S.COL NLV25T-101J	B	115.4/64.3
L7065	6200002041	S.COL NLV25T-101J	B	128.2/14.9
L7066	6140002340	COL LR-263 (T68-2)		
L7067	6140002230	COL LR-235 (T68-2)		
L7068	6140002240	COL LR-236 (T68-2)		
L7091	6200002041	S.COL NLV25T-101J	B	96.1/83.8
L7095	6200002041	S.COL NLV25T-101J	B	110.9/15.5
L7096	6140002260	COL LR-238 (T68-2)		
L7097	6140002230	COL LR-235 (T68-2)		
L7098	6140002230	COL LR-235 (T68-2)		
L7121	6200002041	S.COL NLV25T-101J	B	79.7/80.8
L7125	6200002041	S.COL NLV25T-101J	B	96.2/16
L7126	6140002260	COL LR-238 (T68-2)		
L7127	6140002340	COL LR-263 (T68-2)		
L7128	6140002340	COL LR-263 (T68-2)		
L7151	6200005051	S.COL NLV25T-330J	B	64.5/82.4
L7155	6200005051	S.COL NLV25T-330J	B	75/16.8
L7156	6140002280	COL LR-241 (T68-6)		
L7157	6140002250	COL LR-237 (T68-2)		
L7158	6140002250	COL LR-237 (T68-2)		
L7181	6200005051	S.COL NLV25T-330J	B	50.4/89.7
L7182	6140003580	COL LR-399		
L7183	6140003570	COL LR-398		
L7184	6140003570	COL LR-398		
L7185	6200005051	S.COL NLV25T-330J	B	57.9/17.6
L7211	6200005011	S.COL NLV25T-100J	B	47.3/89
L7215	6200005011	S.COL NLV25T-100J	B	23.1/30.4
L7216	6140003570	COL LR-398		
L7217	6140003570	COL LR-398		
L7218	6140003570	COL LR-398		
L7241	6200005011	S.COL NLV25T-100J	B	6.3/75.3
L7244	6200005011	S.COL NLV25T-100J	B	16.6/30.5
L7245	6140003780	COL LR-437		
L7246	6140003780	COL LR-437		
L7248	6140003780	COL LR-437		
L7271	6200002041	S.COL NLV25T-101J	B	170.9/80.5
L7272	6140003490	COL LR-391		
L7273	6200002041	S.COL NLV25T-101J	B	170.9/87.6
L7321	6140001460	COL LR-170		
L7331	6200002041	S.COL NLV25T-101J	B	24.5/4.6
L7332	6200002041	S.COL NLV25T-101J	B	24.4/10.6
R7271	7030003560	S.RES ERJ3GEYJ 103 V (10 k)	B	167.5/81.6
R7272	7030003490	S.RES ERJ3GEYJ 272 V (2.7 k)	B	166.7/79.4
R7273	7030003520	S.RES ERJ3GEYJ 472 V (4.7 k)	B	163.9/79.4
R7274	7030008190	S.RES ERJ12YJ330U (33)	B	155.4/83.7
R7275	7030003560	S.RES ERJ3GEYJ 103 V (10 k)	B	167.5/85.8
R7276	7030003490	S.RES ERJ3GEYJ 272 V (2.7 k)	B	166.7/88.8
R7277	7030003520	S.RES ERJ3GEYJ 472 V (4.7 k)	B	163.9/88.8
R7301	7030003200	S.RES ERJ3GEYJ 100 V (10)	B	131.3/95.5
R7314	7540000250	ABS SA05C 401N		
R7315	7030010650	S.RES ERJ12YJ823U (82 k)	B	159.1/99.4
C7031	4510009360	ELE 50 ME 1 CZ		
C7032	4030011600	S.CER C1608 JB 1E 104K-T	B	148.9/6.5
C7033	4320001220	S.MIC UC522H 1001J-T	B	157.6/18.8
C7034	4010006410	CER HM13SJ SL 471J 500V		
C7035	4010006410	CER HM13SJ SL 471J 500V		
C7036	4320001220	S.MIC UC522H 1001J-T	B	164.4/32.5
C7037	4010005360	CER HM11SJ SL 301J 500V		
C7038	4010005880	CER HM95SJ SL 271J 500V		
C7039	4320001230	S.MIC UC552H 1201J-T	B	161.8/39.2
C7041	4030011120	S.CER GRM31M2C2H100JV01L	B	178.5/42.5
C7042	4010005930	CER HM11SJ SL 391J 500V		
C7043	4010005930	CER HM11SJ SL 391J 500V		
C7044	4010005930	CER HM11SJ SL 391J 500V		
C7045	4010005370	CER HM11SJ SL 331J 500V		
C7046	4030011600	S.CER C1608 JB 1E 104K-T	B	159.1/60.6
C7049	4010005850	CER HM95SJ SL 181J 500V		
C7050	4320001230	S.MIC UC552H 1201J-T	B	160.7/26.2
C7051	4320001230	S.MIC UC552H 1201J-T	B	166.5/45.7
C7052	4030011740	S.CER GRM32N2C2H201JV01L	B	170/50.7
C7061	4510009360	ELE 50 ME 1 CZ		
C7062	4030011600	S.CER C1608 JB 1E 104K-T	B	128.6/16.8
C7063	4030011730	S.CER GRM31M2C2H101JV01L	B	144.2/25.7
C7064	4010006410	CER HM13SJ SL 471J 500V		
C7065	4010006410	CER HM13SJ SL 471J 500V		

[FILTER UNIT]

REF NO.	ORDER NO.	DESCRIPTION	M.	H/V LOCATION
C7066	4010005370	CER HM11SJ SL 331J 500V		
C7067	4010005880	CER HM95SJ SL 271J 500V		
C7068	4010005880	CER HM95SJ SL 271J 500V		
C7069	4010005880	CER HM95SJ SL 271J 500V		
C7070	4030011730	S.CER GRM31M2C2H101JV01L	B	156/30.5
C7071	4010006410	CER HM13SJ SL 471J 500V		
C7072	4010006410	CER HM13SJ SL 471J 500V		
C7073	4010006410	CER HM13SJ SL 471J 500V		
C7074	4010006410	CER HM13SJ SL 471J 500V		
C7075	4010005370	CER HM11SJ SL 331J 500V		
C7076	4010005370	CER HM11SJ SL 331J 500V		
C7077	4010005370	CER HM11SJ SL 331J 500V		
C7078	4010005930	CER HM11SJ SL 391J 500V		
C7079	4010006410	CER HM13SJ SL 471J 500V		
C7080	4030012480	S.CER GRM31M2C2H121JV01L	B	128.4/48.6
C7081	4030012480	S.CER GRM31M2C2H121JV01L	B	125.7/48.6
C7082	4010005930	CER HM11SJ SL 391J 500V		
C7083	4010005930	CER HM11SJ SL 391J 500V		
C7084	4030011550	S.CER GRM31M2C2H680JV01L	B	138.1/55.1
C7085	4030011600	S.CER C1608 JB 1E 104K-T	B	118.3/61.9
C7086	4030011120	S.CER GRM31M2C2H100JV01L	B	144.2/28.3
C7087	4030012480	S.CER GRM31M2C2H121JV01L	B	152.3/29
C7091	4510009360	ELE 50 ME 1 CZ		
C7092	4030006880	S.CER C1608 JB 1H 472K-T	B	111/17.5
C7094	4010005370	CER HM11SJ SL 331J 500V		
C7095	4010005930	CER HM11SJ SL 391J 500V		
C7096	4010005930	CER HM11SJ SL 391J 500V		
C7098	4010005370	CER HM11SJ SL 331J 500V		
C7099	4010006410	CER HM13SJ SL 471J 500V		
C7100	4030011730	S.CER GRM31M2C2H101JV01L	B	106.6/67.2
C7101	4010005360	CER HM11SJ SL 301J 500V		
C7102	4030006880	S.CER C1608 JB 1H 472K-T	B	102.8/85.3
C7105	4010006410	CER HM13SJ SL 471J 500V		
C7106	4010005830	CER HM74SJ SL 151J 500V		
C7108	4010005370	CER HM11SJ SL 331J 500V		
C7121	4510009360	ELE 50 ME 1 CZ		
C7122	4030006880	S.CER C1608 JB 1H 472K-T	B	93.6/17.5
C7124	4030012480	S.CER GRM31M2C2H121JV01L	B	82/29.4
C7125	4010005930	CER HM11SJ SL 391J 500V		
C7126	4030011120	S.CER GRM31M2C2H100JV01L	B	85.1/41.7
C7127	4030012480	S.CER GRM31M2C2H121JV01L	B	82.5/41.7
C7128	4010005880	CER HM95SJ SL 271J 500V		
C7129	4010005360	CER HM11SJ SL 301J 500V		
C7130	4030011510	S.CER GRM31M2C2H560JV01L	B	86.8/67.2
C7131	4030011070	S.CER GRM31M2C2H5R0CY21L	B	86.8/64.6
C7132	4010005360	CER HM11SJ SL 301J 500V		
C7133	4030006880	S.CER C1608 JB 1H 472K-T	B	85.4/79.6
C7136	4010005850	CER HM95SJ SL 181J 500V		
C7137	4030011730	S.CER GRM31M2C2H101JV01L	B	93.2/28.9
C7151	4510009360	ELE 50 ME 1 CZ		
C7152	4030006880	S.CER C1608 JB 1H 472K-T	B	74/18.7
C7153	4030014460	S.CER GRM31M2C2H820JV01L	B	69.2/39.8
C7154	4010005930	CER HM11SJ SL 391J 500V		
C7155	4030012480	S.CER GRM31M2C2H121JV01L	B	72.5/55.1
C7156	4030011120	S.CER GRM31M2C2H100JV01L	B	74.6/55.1
C7157	4010005930	CER HM11SJ SL 391J 500V		
C7158	4030014460	S.CER GRM31M2C2H820JV01L	B	73.2/67.8
C7160	4030006880	S.CER C1608 JB 1H 472K-T	B	67.8/79.5
C7163	4010005850	CER HM95SJ SL 181J 500V		
C7164	4030014460	S.CER GRM31M2C2H820JV01L	B	65.8/28.6
C7181	4510009360	ELE 50 ME 1 CZ		
C7182	4030006880	S.CER C1608 JB 1H 472K-T	B	63.3/18.7
C7183	4030012480	S.CER GRM31M2C2H121JV01L	B	62.6/24.8
C7184	4030012480	S.CER GRM31M2C2H121JV01L	B	53.1/28.8
C7185	4010005880	CER HM95SJ SL 271J 500V		
C7186	4030011510	S.CER GRM31M2C2H560JV01L	B	53.1/40.6
C7187	4010005370	CER HM11SJ SL 331J 500V		
C7188	4030011180	S.CER GRM31M2C2H220JV01L	B	50.6/68.8
C7190	4030006880	S.CER C1608 JB 1H 472K-T	B	51/85
C7193	4010005850	CER HM95SJ SL 181J 500V		
C7211	4510009360	ELE 50 ME 1 CZ		
C7212	4030006880	S.CER C1608 JB 1H 472K-T	B	25.7/35.3
C7214	4030011240	S.CER GRM31M2C2H470JV01L	B	35.6/61.7
C7216	4030011190	S.CER GRM31M2C2H270JV01L	B	33.1/75.9
C7217	4030012480	S.CER GRM31M2C2H121JV01L	B	29/77.3
C7218	4030006880	S.CER C1608 JB 1H 472K-T	B	44/85.3
C7221	4030014460	S.CER GRM31M2C2H820JV01L	B	30.7/45.2
C7222	4010005860	CER HM95SJ SL 201J 500V		
C7223	4030014460	S.CER GRM31M2C2H820JV01L	B	30.7/47.4
C7224	4030011210	S.CER GRM31M2C2H330JV01L	B	30.3/65.8
C7225	4030011190	S.CER GRM31M2C2H270JV01L	B	30.7/42.9
C7241	4030006880	S.CER C1608 JB 1H 472K-T	B	15.3/35.1
C7242	4030011730	S.CER GRM31M2C2H101JV01L	B	9.2/46.6
C7243	4030011510	S.CER GRM31M2C2H560JV01L	B	9.2/48.9
C7244	4030011180	S.CER GRM31M2C2H220JV01L	B	8.8/57.7
C7247	4030011190	S.CER GRM31M2C2H270JV01L	B	16.3/65.6
C7248	4030011210	S.CER GRM31M2C2H330JV01L	B	24.7/60.6
C7249	4030011230	S.CER GRM31M2C2H390JV01L	B	24.2/65.8
C7250	4030006880	S.CER C1608 JB 1H 472K-T	B	9.1/80.1
C7253	4010005830	CER HM74SJ SL 151J 500V		
C7254	4030011180	S.CER GRM31M2C2H220JV01L		

[FILTER UNIT]

REF NO.	ORDER NO.	DESCRIPTION	M.	H/V LOCATION
C7272	4030006900	S.CER C1608 JB 1H 103K-T	B	159/80.3
C7273	4030007090	S.CER C1608 CH 1H 470J-T	B	165.4/86.1
C7274	4030006870	S.CER C1608 JB 1H 222K-T	B	159/87.1
C7275	4610001340	TRI ECR-LA010 A12		
C7277	4010005850	CER HM95SJ SL 181J 500V		
C7278	4030007090	S.CER C1608 CH 1H 470J-T	B	163.2/81.3
C7301	4030006880	S.CER C1608 JB 1H 472K-T	B	136.3/90.7
C7302	4030006880	S.CER C1608 JB 1H 472K-T	B	139.2/86.2
C7303	4030006880	S.CER C1608 JB 1H 472K-T	B	137.1/88.4
C7304	4030006880	S.CER C1608 JB 1H 472K-T	B	129.4/99.2
C7321	4030011730	S.CER GRM31M2C2H101JV01L	B	163.9/74
C7322	4030011170	S.CER GRM31M2C2H180JV01L	B	166.9/69.3
C7323	4030011730	S.CER GRM31M2C2H101JV01L	B	169.7/74
C7325	4030011790	S.CER GRM55RF52A684ZD01L	B	155.1/72.6
C7332	4030006880	S.CER C1608 JB 1H 472K-T	B	22.1/10.5
C7345	4030006880	S.CER C1608 JB 1H 472K-T	B	27.1/11.7
RL7031	6330001570	RLY AJS1315		
RL7032	6330001570	RLY AJS1315		
RL7061	6330001570	RLY AJS1315		
RL7062	6330001570	RLY AJS1315		
RL7091	6330001570	RLY AJS1315		
RL7092	6330001570	RLY AJS1315		
RL7121	6330001570	RLY AJS1315		
RL7122	6330001570	RLY AJS1315		
RL7151	6330001570	RLY AJS1315		
RL7152	6330001570	RLY AJS1315		
RL7181	6330001570	RLY AJS1315		
RL7182	6330001570	RLY AJS1315		
RL7211	6330001570	RLY AJS1315		
RL7212	6330001570	RLY AJS1315		
RL7241	6330001570	RLY AJS1315		
RL7242	6330001570	RLY AJS1315		
RL7301	6330000780	RLY AGP 2013		
J7001	6510007020	CNR TMP-J01X-V6		
J7311	6510007020	CNR TMP-J01X-V6		
J7331	6510022561	CNR 16FMN-BTRK-A (LF) (SN)		
W7321	8970024700	WIR 62/99/360/C24/C31		

[REG-DC UNIT]

REF NO.	ORDER NO.	DESCRIPTION	M.	H/V LOCATION
IC301	1110003071	S.IC μPC494GS-E1-A	T	19.1/202.5
IC302	1180002261	S.IC TA78L12F (TE12L,F)	T	40.5/208.2
IC401	1190002250	S.IC TLP131 (GB-TPL,F)	T	49.4/111.9
IC402	1190002220	S.IC TLP141G (N,F)	T	55.7/112
IC403	1110001241	S.IC μPC358G2-T1-A	T	54/69
Q101	1590003610	FET STP120NF10		
Q102	1590003610	FET STP120NF10		
Q103	1590003610	FET STP120NF10		
Q104	1590003610	FET STP120NF10		
Q301	1510000801	S.TR 2SA1213-Y (TE12R, CF)	T	36.4/192.7
Q302	1510000801	S.TR 2SA1213-Y (TE12R, CF)	T	37.7/200
Q401	1510000771	S.TR 2SA1586-GR (TE85R,F)	T	50.8/91.7
D101	1710001230	DIO S3V60-5000		
D102	1730002430	S.ZEN MA8150-M (TX)	T	37.2/196.2
D103	1730002430	S.ZEN MA8150-M (TX)	T	38.4/203.4
D201	1710001220	DIO MUR3020WTG		
D202	1710001220	DIO MUR3020WTG		
D203	1790001491	DIO D1NL20U-5070		
D301	1750000291	S.DIO 1SS300 (TE85R,F)	T	40.7/192.1
D302	1750000291	S.DIO 1SS300 (TE85R,F)	T	41.9/199.4
D303	1790001250	S.DIO MA2S111-(TX)	T	10.9/194.4
D304	1790001250	S.DIO MA2S111-(TX)	T	10.9/197.1
D401	1730002320	S.ZEN MA8051-M (TX)	T	50.4/102.6
D402	1790001250	S.DIO MA2S111-(TX)	T	48.4/102.4
D403	1790001250	S.DIO MA2S111-(TX)	T	50.4/99.2
D404	1790001250	S.DIO MA2S111-(TX)	T	48.4/99.2
D405	1730002320	S.ZEN MA8051-M (TX)	T	55.3/62.5
D406	1790001250	S.DIO MA2S111-(TX)	T	49.1/96.7
D407	1790001250	S.DIO MA2S111-(TX)	T	51.7/97.5
L101	6190001670	COL FK-230N-1020H		
L102	6190001670	COL FK-230N-1020H [12 V] only		
L201	6190001700	COL HD3535-1928V		
L202	6140004630	COL LR-522		
L203	6140004630	COL LR-522		
L221	6910000670	COL BL01RN1A1D2B		
L222	6910000670	COL BL01RN1A1D2B		
R101	7030003720	S.RES ERJ3GEYJ 224 V (220 k)	T	172.2/81.2
R102	7070000321	RES ERX1SJ 3R3 (3.3)		
R103	7070000321	RES ERX1SJ 3R3 (3.3)		
R104	7070000251	RES ERX2SJ 4R7 (4.7)		
R105	7070000251	RES ERX2SJ 4R7 (4.7)		
R106	7070000321	RES ERX1SJ 3R3 (3.3)		
R107	7070000321	RES ERX1SJ 3R3 (3.3)		
R201	7070000601	RES ERG2SJ 470 (47)		
R202	7070000601	RES ERG2SJ 470 (47)		
R203	7070000601	RES ERG2SJ 470 (47)		
R204	7120000510	RES LR20DT10 5LO		
R205	7120000510	RES LR20DT10 5LO		
R301	7030003440	S.RES ERJ3GEYJ 102 V (1 k)	T	32.4/191.9
R302	7030003440	S.RES ERJ3GEYJ 102 V (1 k)	T	33.3/199.2
R303	7030003570	S.RES ERJ3GEYJ 123 V (12 k) [12 V]	T	12.4/203.6
	7030003620	S.RES ERJ3GEYJ 333 V (33 k) [24 V]	T	12.4/203.6
R304	7030003520	S.RES ERJ3GEYJ 472 V (4.7 k) [12 V]	T	10.7/200.3
	7030003530	S.RES ERJ3GEYJ 562 V (5.6 k) [24 V]	T	10.7/200.3
R305	7030003320	S.RES ERJ3GEYJ 101 V (100)	T	20.4/208.3
R306	7030003520	S.RES ERJ3GEYJ 472 V (4.7 k)	T	12.4/206.8
R307	7030003520	S.RES ERJ3GEYJ 472 V (4.7 k)	T	10.7/206.8
R308	7030003440	S.RES ERJ3GEYJ 102 V (1 k)	T	16.3/208.3
R309	7030003620	S.RES ERJ3GEYJ 333 V (33 k)	T	12.4/200.3
R310	7030003490	S.RES ERJ3GEYJ 272 V (2.7 k)	T	23/196.7
R311	7030003480	S.RES ERJ3GEYJ 222 V (2.2 k)	T	18.5/195.5
R312	7030003610	S.RES ERJ3GEYJ 273 V (27 k)	T	55.7/120.2
R313	7030003720	S.RES ERJ3GEYJ 224 V (220 k)	T	48.2/118.2
R314	7030003550	S.RES ERJ3GEYJ 822 V (8.2 k) [24 V]	T	11.5/208.9
	7030003860	S.RES ERJ3GE JPW V [12 V]	T	11.5/208.9
R315	7030003390	S.RES ERJ3GEYJ 391 V (390)	T	10.7/203.6
R401	7030003430	S.RES ERJ3GEYJ 821 V (820)	T	48.1/105.9
R402	7030003520	S.RES ERJ3GEYJ 472 V (4.7 k)	T	50.2/62.9
R403	7030003720	S.RES ERJ3GEYJ 224 V (220 k)	T	52.5/63.7
R404	7030003480	S.RES ERJ3GEYJ 222 V (2.2 k)	T	52.5/62.2
R405	7030003420	S.RES ERJ3GEYJ 681 V (680)	T	52.4/106.6
R406	7030003520	S.RES ERJ3GEYJ 472 V (4.7 k)	T	54.8/106.8
R407	7030003450	S.RES ERJ3GEYJ 122 V (1.2 k)	T	57.5/62.2
R408	7030003760	S.RES ERJ3GEYJ 474 V (470 k)	T	52/74.4
R409	7030003520	S.RES ERJ3GEYJ 472 V (4.7 k)	T	47.8/74.4
R410	7030003620	S.RES ERJ3GEYJ 333 V (33 k)	T	56.6/74.5
R411	7030003400	S.RES ERJ3GEYJ 471 V (470)	T	57.1/65.1
R412	7030003380	S.RES ERJ3GEYJ 331 V (330)	T	52.9/76.6
R414	7030003530	S.RES ERJ3GEYJ 562 V (5.6 k)	T	39/47
R415	7310005140	S.TRI RH03ADCJ3X (2.2 k)	T	39/43.8
R416	7030003500	S.RES ERJ3GEYJ 332 V (3.3 k)	T	39/40.2
R418	7520000120	POS PTFM04BC222Q2N34B0		
R419	7030003640	S.RES ERJ3GEYJ 473 V (47 k)	T	56.2/96.4
R420	7310005110	S.TRI RH03ADCS2X (470)	T	55.7/79.7

M.=Mounted side (T: Mounted on the Top side, B: Mounted on the Bottom side)  
S.=Surface mount

[REG-DC UNIT]

REF NO.	ORDER NO.	DESCRIPTION	M.	H/V LOCATION
C101	4310000860	MLR 50 F2D 474J		
C102	4510007351	ELE 35 ME 1000 AX		
C103	4310000860	MLR 50 F2D 474J		
C104	4310000860	MLR 50 F2D 474J		
C105	4510008451	ELE 35 ME 2200 AX		
C107	4340000320	S.MLR ECHU1H473JC9	T	119.3/188
C108	4340000320	S.MLR ECHU1H473JC9	T	123.2/202.5
C110	4340000330	S.MLR ECHU1H103J	T	116/188.9
C111	4340000330	S.MLR ECHU1H103J	T	126.3/201.7
C112	4510007351	ELE 35 ME 1000 AX		
C113	4510007351	ELE 35 ME 1000 AX		
C114	4510007351	ELE 35 ME 1000 AX		
C115	4340000340	S.MLR ECWU1103JX5	T	64.9/172.2
C116	4340000340	S.MLR ECWU1103JX5	T	88.4/172.2
C117	4310001210	MLR 250 MMB 473K		
C118	4510007351	ELE 35 ME 1000 AX		
C119	4510007351	ELE 35 ME 1000 AX		
C120	4510007351	ELE 35 ME 1000 AX		
C201	4340000340	S.MLR ECWU1103JX5	T	74.1/35.2
C202	4340000340	S.MLR ECWU1103JX5	T	78.3/40.4
C203	4340000340	S.MLR ECWU1103JX5	T	85.5/40.4
C204	4510009180	ELE 25 ME 2700 AX		
C205	4510009180	ELE 25 ME 2700 AX		
C206	4510009180	ELE 25 ME 2700 AX		
C207	4340000330	S.MLR ECHU1H103J	T	48.4/12.9
C208	4340000330	S.MLR ECHU1H103J	T	53.8/21.8
C209	4510009180	ELE 25 ME 2700 AX		
C210	4510009180	ELE 25 ME 2700 AX		
C211	4510009180	ELE 25 ME 2700 AX		
C212	4340000350	S.MLR ECWU1C474JC9	T	27.6/22.4
C213	4340000350	S.MLR ECWU1C474JC9	T	8.5/34.4
C301	4340000360	S.MLR ECWU1H104JC9	T	35.5/208.6
C302	4340000360	S.MLR ECWU1H104JC9	T	7.5/201.5
C303	4510007180	ELE 50 ME 47 CZ		
C304	4340000330	S.MLR ECHU1H103J	T	20.3/194.8
C305	4340000330	S.MLR ECHU1H103J	T	16.5/194.7
C306	4340000250	S.MLR ECHU 1C 104JX5	T	13.4/194.7
C307	4510008970	S.ELE EEEHB1C100R	T	7.6/194.6
C308	4340000330	S.MLR ECHU1H103J	T	55.7/118.3
C401	4340000250	S.MLR ECHU 1C 104JX5	T	52/59.7
C402	4340000380	S.MLR ECHU1C473JX5	T	48.6/77
C403	4510009330	S.ELE EEEHA1E470WP	T	47.4/69.1
C404	4510008970	S.ELE EEEHB1C100R	T	55.2/102.9
C405	4510009290	S.ELE EEEHB1H1R0R	T	34.6/44
C407	4340000250	S.MLR ECHU 1C 104JX5	T	54/91.3
RL101	6330001830	RLY ALF1P12		
RL102	6330001830	RLY ALF1P12		
RL103	6330001830	RLY ALF1P12		[12 V] only
J101	6510004980	CNR RTB-1.5-4F		
F101	5210000061	FUS FGB 5A PBF (FGB0 125 V)		
F102	5220000230	HOL S-N5054		
F103	5220000230	HOL S-N5054		
T101	5910001030	TSM TP-74 (12V)		[12 V]
	5910001040	TSM TP-75 (24V)		[24 V]
EP101	6910010910	TER PB-3-S		
EP102	6910010910	TER PB-3-S		
EP104	6910010910	TER PB-3-S		
EP105	6910010910	TER PB-3-S		
EP106	6910010910	TER PB-3-S		
EP107	6910010910	TER PB-3-S		
EP201	6910011330	TER OT-009 M3		
EP202	6910011330	TER OT-009 M3		
EP205	6910011330	TER OT-009 M3		
EP206	6910010910	TER PB-3-S		
EP207	6910011330	TER OT-009 M3		
EP418	9029702901	TUB IRRAX 0.7 (d) L=8 mm		

[DSP BOARD]

REF NO.	ORDER NO.	DESCRIPTION	M.	H/V LOCATION
IC1	1130010011	S.IC TC7WHU04FU (TE12K,F)	T	54.6/17
IC3	1130010540	S.IC SN74AHC74PWR	B	51.9/12.2
IC4	1130010540	S.IC SN74AHC74PWR	B	56.1/22.1
IC51	1130010011	S.IC TC7WHU04FU (TE12K,F)	T	31.7/15.1
IC101	1130010520	S.IC SN74HCT244APWR	T	18.9/21.8
IC102	1110004770	S.IC BU9480F-E2	B	68.7/4.5
IC152	1180002321	S.REG TK11218CMCL-G	T	77.8/46.9
IC161	1180002020	S.REG BA033FP-E2	B	64/43.1
IC171	1180002271	S.REG TK11250CMCL-G	T	78.4/3.6
IC201	1130012701	S.IC AT49LV1024A-45VU	B	41.4/37.8
IC202	1130008041	S.IC TC7SH04FU (TE85L,JF)	B	51.1/40.5
IC203	1130008811	S.IC TC7SH32FU (TE85L,JF)	B	52/30.3
IC301	1140010330	S.IC TMS320VC33PGEA120	T	41.1/32.9
IC401	1130010550	S.IC SN74AHC595PWR	T	18.9/31.7
IC403	1130010530	S.IC SN74AHCT374PWR	B	18.8/42.2
IC404	1130010530	S.IC SN74AHCT374PWR	B	18.8/31.6
IC405	1130004670	S.IC BU4021BF-E2	B	19.1/22.9
IC406	1130010540	S.IC SN74AHC74PWR	T	18.9/11.8
IC501	1190001611	S.IC AK4528VFP-E2/P	T	64.5/25.6
IC601	1110005420	S.IC BA15532F-E2	B	74.7/42
IC651	1110005420	S.IC BA15532F-E2	B	75/31.1
IC701	1110001901	S.IC μPC4570G2-T1-A	B	72.3/15.7
IC801	1130010560	S.IC SN74AHC244PWR	B	17.9/10.3
Q201	1590001660	S.TR XP4312 (TX)	B	41.3/31.2
Q301	1590000430	S.TR DTC144EUA T106	T	10.1/44.9
Q302	1590000430	S.TR DTC144EUA T106	T	10.1/47.4
D301	1750000370	S.DIO DA221 TL	T	27.5/41.8
D302	1750000370	S.DIO DA221 TL	T	28.1/45.3
D303	1750000370	S.DIO DA221 TL	T	27.6/47.4
D304	1750000370	S.DIO DA221 TL	B	34.5/22.5
D901	1790000970	S.DIO MA729 (TX)	T	10.2/42.8
X1	6050009860	S.XTL CR-566 (12.288 MHz)	T	50.4/11.4
X51	6050011270	S.XTL CR-709 (60.000 MHz)	T	32.2/9.3
L1	6200003281	S.COL NLV25T-2R2J	T	54.4/21.3
L2	6200003281	S.COL NLV25T-2R2J	B	48.1/16.7
L3	6200003281	S.COL NLV25T-2R2J	B	61.2/18.6
L51	6200003281	S.COL NLV25T-2R2J	T	36.1/14.5
L52	6200001981	S.COL NLV25T-1R0J	T	27.4/15.2
L101	6200003281	S.COL NLV25T-2R2J	T	17.1/16.2
L102	6200003281	S.COL NLV25T-2R2J	T	66.9/7.4
L301	6200003281	S.COL NLV25T-2R2J	B	56.4/46.9
L302	6200009840	S.COL LQH32CN2R2M23L	B	57.5/39.7
L401	6200003281	S.COL NLV25T-2R2J	T	13.7/34.7
L403	6200003281	S.COL NLV25T-2R2J	B	23.8/46.4
L404	6200003281	S.COL NLV25T-2R2J	B	23.8/35.7
L405	6200003281	S.COL NLV25T-2R2J	B	12.6/18.8
L406	6200003281	S.COL NLV25T-2R2J	T	13.3/8.7
L501	6200003281	S.COL NLV25T-2R2J	T	60.8/19
L502	6200003281	S.COL NLV25T-2R2J	T	69.8/7.8
L601	6200002041	S.COL NLV25T-101J	T	79.2/37.5
L651	6200002041	S.COL NLV25T-101J	T	78.6/27
L701	6200002041	S.COL NLV25T-101J	T	77.9/16.6
L801	6200003281	S.COL NLV25T-2R2J	B	12.2/7.3
R1	7030003800	S.RES ERJ3GEYJ 105 V (1 M)	T	50.5/14.7
R2	7030003440	S.RES ERJ3GEYJ 102 V (1 k)	T	55.7/17.4
R3	7030003640	S.RES ERJ3GEYJ 473 V (47 k)	T	58.4/20.4
R4	7030003860	S.RES ERJ3GE JPW V	T	53/19.4
R5	7030008240	S.RES ERJ12YJ0R00U	B	59.8/30.1
R6	7030003860	S.RES ERJ3GE JPW V	B	58.8/16.1
R7	7030008240	S.RES ERJ12YJ0R00U	B	58.8/4.5
R8	7030003860	S.RES ERJ3GE JPW V	T	57.4/2.4
R51	7030003800	S.RES ERJ3GEYJ 105 V (1 M)	T	30.5/12.6
R52	7030003320	S.RES ERJ3GEYJ 101 V (100)	T	36.5/12.6
R151	7030007240	S.RES ERJ12YJ680U (68)	B	82.3/44.1
R152	7030008240	S.RES ERJ12YJ0R00U	B	77.3/5
R153	7030003860	S.RES ERJ3GE JPW V	T	84.8/43.7
R161	7030008190	S.RES ERJ12YJ330U (33)	T	66.1/45.6
R162	7030007510	S.RES ERJ12YJ270U (27)	T	66.1/41.9
R171	7030007180	S.RES ERJ12YJ150U (15)	B	83.4/6
R172	7030008240	S.RES ERJ12YJ0R00U	B	78.4/9.9
R201	7030003640	S.RES ERJ3GEYJ 473 V (47 k)	B	37.8/31.4
R202	7030003860	S.RES ERJ3GE JPW V	B	37.5/43.9
R203	7030003860	S.RES ERJ3GE JPW V	B	53.4/45.1
R204	7030003860	S.RES ERJ3GE JPW V	B	58.2/26.5
R302	7030003860	S.RES ERJ3GE JPW V	B	36.9/26.8
R303	7030003480	S.RES ERJ3GEYJ 222 V (2.2 k)	B	48.2/22.7
R304	7030003480	S.RES ERJ3GEYJ 222 V (2.2 k)	B	46.9/22.7
R305	7030003560	S.RES ERJ3GEYJ 103 V (10 k)	B	47.1/26.2
R306	7030003560	S.RES ERJ3GEYJ 103 V (10 k)	B	45.6/22.7
R307	7030003560	S.RES ERJ3GEYJ 103 V (10 k)	B	42.7/22.7
R308	7030003560	S.RES ERJ3GEYJ 103 V (10 k)	B	41.4/22.7
R309	7030003560	S.RES ERJ3GEYJ 103 V (10 k)	B	40.1/22.7

M.=Mounted side (T: Mounted on the Top side, B: Mounted on the Bottom side)

S.=Surface mount

[DSP BOARD]

REF NO.	ORDER NO.	DESCRIPTION	M.	H/V LOCATION
R310	7030003560	S.RES ERJ3GEYJ 103 V (10 k)	B	38.8/22.7
R311	7030003560	S.RES ERJ3GEYJ 103 V (10 k)	B	38.9/26.8
R312	7030003560	S.RES ERJ3GEYJ 103 V (10 k)	B	37.5/22.7
R313	7030003560	S.RES ERJ3GEYJ 103 V (10 k)	B	36.2/22.7
R317	7030003560	S.RES ERJ3GEYJ 103 V (10 k)	T	46.1/48.1
R318	7030003560	S.RES ERJ3GEYJ 103 V (10 k)	T	43.6/46.2
R320	7030003520	S.RES ERJ3GEYJ 472 V (4.7 k)	B	31/30.3
R321	7030003520	S.RES ERJ3GEYJ 472 V (4.7 k)	B	31/31.6
R322	7030003280	S.RES ERJ3GEYJ 470 V (47)	B	13.8/40.9
R323	7030003560	S.RES ERJ3GEYJ 103 V (10 k)	B	28.2/45.4
R324	7030003560	S.RES ERJ3GEYJ 103 V (10 k)	B	28.2/46.7
R325	7030003560	S.RES ERJ3GEYJ 103 V (10 k)	T	54.8/43.1
R326	7030003560	S.RES ERJ3GEYJ 103 V (10 k)	T	52.7/48.5
R327	7030003560	S.RES ERJ3GEYJ 103 V (10 k)	T	25.8/43.1
R328	7030003560	S.RES ERJ3GEYJ 103 V (10 k)	T	25.8/40.5
R329	7030003440	S.RES ERJ3GEYJ 102 V (1 k)	B	30.9/20.1
R330	7030003440	S.RES ERJ3GEYJ 102 V (1 k)	B	29.6/20.1
R331	7030003440	S.RES ERJ3GEYJ 102 V (1 k)	B	13.7/11.8
R332	7030003440	S.RES ERJ3GEYJ 102 V (1 k)	T	23.1/7.7
R336	7030003860	S.RES ERJ3GE JPW V	T	55.4/23.8
R337	7030003860	S.RES ERJ3GE JPW V	B	44.6/27
R338	7030003860	S.RES ERJ3GE JPW V	B	43.3/27
R339	7030003860	S.RES ERJ3GE JPW V	B	42/27
R340	7030003860	S.RES ERJ3GE JPW V	B	50.9/43.3
R341	7030003860	S.RES ERJ3GE JPW V	T	52.7/47.2
R501	7030004040	S.RES ERJ3GEYJ 47V (4.7)	T	62.3/30.9
R502	7030003860	S.RES ERJ3GE JPW V	T	58.1/25.6
R503	7030003860	S.RES ERJ3GE JPW V	T	58.6/14
R504	7030003860	S.RES ERJ3GE JPW V	T	64.8/12
R505	7030003860	S.RES ERJ3GE JPW V	T	58.6/29.5
R506	7030008240	S.RES ERJ12YJ0R00U	T	59.8/37.1
R601	7030006581	S.RES ERA3YED 122V (1.2 k)	T	76.8/35.8
R602	7030009591	S.RES ERA3YED 472V (4.7 k)	T	75.6/37.1
R603	7030010450	S.RES ERA3YED 391V (390)	T	72/37.9
R604	7030010450	S.RES ERA3YED 391V (390)	B	79.3/37.9
R605	7030007230	S.RES ERA3YED 102V (1 k)	B	77.1/37.2
R606	7030007230	S.RES ERA3YED 102V (1 k)	B	74.4/38.5
R607	7030009591	S.RES ERA3YED 472V (4.7 k)	T	70.9/40.5
R608	7030009591	S.RES ERA3YED 472V (4.7 k)	T	72.2/40.5
R609	7030009591	S.RES ERA3YED 472V (4.7 k)	B	79.3/40.6
R610	7030009591	S.RES ERA3YED 472V (4.7 k)	B	81.2/40.6
R611	7030005331	S.RES ERA3YED 562V (5.6 k)	B	74.4/35.7
R651	7030010450	S.RES ERA3YED 391V (390)	B	71.7/27.1
R652	7030010450	S.RES ERA3YED 391V (390)	B	79.5/28.4
R653	7030007230	S.RES ERA3YED 102V (1 k)	B	76.6/26.3
R654	7030007230	S.RES ERA3YED 102V (1 k)	B	74/27.6
R655	7030009591	S.RES ERA3YED 472V (4.7 k)	B	70.4/29.7
R656	7030009591	S.RES ERA3YED 472V (4.7 k)	T	74.2/31
R657	7030009591	S.RES ERA3YED 472V (4.7 k)	B	79.5/31
R658	7030009591	S.RES ERA3YED 472V (4.7 k)	B	79.5/33.7
R659	7030005331	S.RES ERA3YED 562V (5.6 k)	B	74/25
R701	7030003520	S.RES ERJ3GEYJ 472 V (4.7 k)	B	70.5/24.3
R702	7030003520	S.RES ERJ3GEYJ 472 V (4.7 k)	B	69.6/23
R703	7030003500	S.RES ERJ3GEYJ 332 V (3.3 k)	B	74.2/21.1
R704	7030003540	S.RES ERJ3GEYJ 682 V (6.8 k)	B	72.3/21.7
R705	7030003500	S.RES ERJ3GEYJ 332 V (3.3 k)	B	69.6/21.7
R706	7030003540	S.RES ERJ3GEYJ 682 V (6.8 k)	B	69.6/20.4
R707	7030003440	S.RES ERJ3GEYJ 102 V (1 k)	B	67.7/22.5
R708	7030003440	S.RES ERJ3GEYJ 102 V (1 k)	T	68.7/16.3
R751	7030003520	S.RES ERJ3GEYJ 472 V (4.7 k)	T	65.4/17.5
R752	7030003520	S.RES ERJ3GEYJ 472 V (4.7 k)	T	66.9/17.5
R753	7030003500	S.RES ERJ3GEYJ 332 V (3.3 k)	B	73.1/19.5
R754	7030003540	S.RES ERJ3GEYJ 682 V (6.8 k)	B	70.4/10.8
R755	7030003500	S.RES ERJ3GEYJ 332 V (3.3 k)	B	65.3/13.7
R756	7030003540	S.RES ERJ3GEYJ 682 V (6.8 k)	B	68.4/13.7
R757	7030003440	S.RES ERJ3GEYJ 102 V (1 k)	B	65.3/15.4
R758	7030003440	S.RES ERJ3GEYJ 102 V (1 k)	B	65.3/12.4
R801	7030003680	S.RES ERJ3GEYJ 104 V (100 k)	T	6.7/6.8
R802	7030003680	S.RES ERJ3GEYJ 104 V (100 k)	T	5.4/6.8
R803	7030003680	S.RES ERJ3GEYJ 104 V (100 k)	B	22.5/7.3
R804	7030003680	S.RES ERJ3GEYJ 104 V (100 k)	B	22/10.6
R805	7030003680	S.RES ERJ3GEYJ 104 V (100 k)	T	16.9/5.8
R901	7030003560	S.RES ERJ3GEYJ 103 V (10 k)	T	11.4/6.9
R902	7030003560	S.RES ERJ3GEYJ 103 V (10 k)	T	10.1/6.9
R903	7030003560	S.RES ERJ3GEYJ 103 V (10 k)	T	8/6.8
R904	7030003560	S.RES ERJ3GEYJ 103 V (10 k)	T	13.9/11.8
R905	7030003560	S.RES ERJ3GEYJ 103 V (10 k)	T	19.8/26.2
R906	7030003560	S.RES ERJ3GEYJ 103 V (10 k)	T	12.3/16.2
R907	7030003860	S.RES ERJ3GE JPW V	T	12.1/18.1
R908	7030008240	S.RES ERJ12YJ0R00U	T	12.2/25.8
R909	7030003860	S.RES ERJ3GE JPW V	T	11.5/20.3
R910	7030003860	S.RES ERJ3GE JPW V	B	13.1/24
C1	4030006880	S.CER C1608 JB 1H 472K-T	T	55.6/19.4
C2	4030007060	S.CER C1608 CH 1H 270J-T	T	53.1/14.7
C3	4030007060	S.CER C1608 CH 1H 270J-T	T	50.5/16.2
C4	4030006880	S.CER C1608 JB 1H 472K-T	B	50.8/15.6
C6	4030007090	S.CER C1608 CH 1H 470J-T	T	58.3/15.8
C7	4030011600	S.CER C1608 JB 1E 104K-T	B	56.1/18.7
C8	4030007010	S.CER C1608 CH 1H 100D-T	T	50.6/17.8
C9	4030006960	S.CER C1608 CH 1H 050C-T	B	57/13.1

[DSP BOARD]

REF NO.	ORDER NO.	DESCRIPTION	M.	H/V LOCATION
C51	4030006880	S.CER C1608 JB 1H 472K-T	T	31.5/17.6
C52	4030009920	S.CER C1608 CH 1H 050B-T	T	27.7/12.6
C53	4030009920	S.CER C1608 CH 1H 050B-T	T	33.3/12.6
C54	4030006900	S.CER C1608 JB 1H 103K-T	T	27.9/17.6
C101	4030011600	S.CER C1608 JB 1E 104K-T	T	19.8/17.5
C102	4510008970	S.ELE EEEHB1C100R	T	61.9/2.6
C103	4030011600	S.CER C1608 JB 1E 104K-T	B	66.7/8.1
C104	4510008970	S.ELE EEEHB1C100R	T	67.1/3.3
C154	4030011600	S.CER C1608 JB 1E 104K-T	T	75.1/48.3
C155	4030011600	S.CER C1608 JB 1E 104K-T	T	78.6/44.2
C156	4030011600	S.CER C1608 JB 1E 104K-T	T	75.1/45.4
C157	4510008970	S.ELE EEEHB1C100R	T	72/46.3
C158	4550006080	S.TAN TEESVB2 1C 106M8R	T	81.8/46.7
C161	4550007320	S.TAN F930J226MAABMA	T	57.4/44.8
C162	4030011600	S.CER C1608 JB 1E 104K-T	B	59.8/42.4
C163	4030011600	S.CER C1608 JB 1E 104K-T	B	68.2/41.2
C164	4510008970	S.ELE EEEHB1C100R	T	60.8/44.4
C171	4030011600	S.CER C1608 JB 1E 104K-T	T	75.7/4.2
C172	4030011600	S.CER C1608 JB 1E 104K-T	T	78.5/6.3
C173	4030011600	S.CER C1608 JB 1E 104K-T	T	77.8/9
C174	4510008970	S.ELE EEEHB1C100R	T	72.7/3.3
C175	4510008970	S.ELE EEEHB1C100R	T	82.8/3.3
C201	4030011600	S.CER C1608 JB 1E 104K-T	B	40.1/43.9
C202	4030011600	S.CER C1608 JB 1E 104K-T	B	52.1/38.3
C203	4030011600	S.CER C1608 JB 1E 104K-T	B	54.5/31.2
C301	4030006880	S.CER C1608 JB 1H 472K-T	T	55.1/27.1
C302	4030006880	S.CER C1608 JB 1H 472K-T	T	55.1/29.7
C303	4030011600	S.CER C1608 JB 1E 104K-T	T	55.1/32.3
C304	4030006880	S.CER C1608 JB 1H 472K-T	T	55.1/34.9
C305	4030011600	S.CER C1608 JB 1E 104K-T	T	55.1/37.5
C306	4030011600	S.CER C1608 JB 1E 104K-T	T	55.1/40.1
C307	4030011600	S.CER C1608 JB 1E 104K-T	T	48.1/19.2
C308	4030011600	S.CER C1608 JB 1E 104K-T	T	45.4/19.2
C309	4030006880	S.CER C1608 JB 1H 472K-T	T	42.1/18.9
C311	4030006880	S.CER C1608 JB 1H 472K-T	T	39.3/18.9
C312	4030011600	S.CER C1608 JB 1E 104K-T	T	36.3/18.9
C313	4030011600	S.CER C1608 JB 1E 104K-T	T	49.4/47.2
C314	4030006880	S.CER C1608 JB 1H 472K-T	T	47.5/48.1
C315	4030011600	S.CER C1608 JB 1E 104K-T	T	44.2/47.5
C316	4030006880	S.CER C1608 JB 1H 472K-T	T	41.6/47.3
C317	4030011600	S.CER C1608 JB 1E 104K-T	T	39/47.2
C318	4030006880	S.CER C1608 JB 1H 472K-T	T	36.4/47.2
C319	4030006880	S.CER C1608 JB 1H 472K-T	T	32.9/47.2
C320	4030011600	S.CER C1608 JB 1E 104K-T	T	27.1/25.3
C321	4030011600	S.CER C1608 JB 1E 104K-T	T	27.1/28.9
C322	4030006880	S.CER C1608 JB 1H 472K-T	T	27.1/31.5
C323	4030011600	S.CER C1608 JB 1E 104K-T	T	27.1/34.1
C324	4030006880	S.CER C1608 JB 1H 472K-T	T	27.1/36.7
C325	4030006880	S.CER C1608 JB 1H 472K-T	T	27.1/39.3
C401	4030006880	S.CER C1608 JB 1H 472K-T	T	18.6/28
C403	4030006880	S.CER C1608 JB 1H 472K-T	B	22.9/43.9
C404	4030006880	S.CER C1608 JB 1H 472K-T	B	23/33
C405	4030006880	S.CER C1608 JB 1H 472K-T	B	15.4/18
C406	4030006880	S.CER C1608 JB 1H 472K-T	T	17/8.2
C407	4030006880	S.CER C1608 JB 1H 102K-T	B	24.2/43.6
C408	4030006880	S.CER C1608 JB 1H 102K-T	B	24/7.6
C504	4510009340	S.ELE EEEHB1H2R2R	T	67.3/35.6
C505	4030011600	S.CER C1608 JB 1E 104K-T	T	68/32.1
C506	4550007320	S.TAN F930J226MAABMA	T	62.5/33.2
C507	4030011600	S.CER C1608 JB 1E 104K-T	T	64.9/30.8
C508	4030011600	S.CER C1608 JB 1E 104K-T	T	63.5/19.5
C509	4030011600	S.CER C1608 JB 1E 104K-T	T	63.5/18
C510	4550007320	S.TAN F930J226MAABMA	T	62.3/15.2
C511	4030007050	S.CER C1608 CH 1H 220J-T	B	62.9/25.4
C601	4510008970	S.ELE EEEHB1C100R	T	73/34.1
C602	4030009980	S.CER C1608 JB 1H 152K-T	B	74.4/37.2
C603	4030011600	S.CER C1608 JB 1E 104K-T	B	77.1/38.5
C604	4510008970	S.ELE EEEHB1C100R	T	75.3/40.6
C605	4030011600	S.CER C1608 JB 1E 104K-T	B	70.4/43.3
C606	4510009290	S.ELE EEEHB1H1R0R	T	81.8/41.1
C651	4030009980	S.CER C1608 JB 1H 152K-T	B	74/26.3
C652	4030011600	S.CER C1608 JB 1E 104K-T	B	76.6/27.6
C653	4510008970	S.ELE EEEHB1C100R	T	74.3/27
C654	4030011600	S.CER C1608 JB 1E 104K-T	B	70.4/32.6
C655	4510009290	S.ELE EEEHB1H1R0R	T	78.3/32.1
C701	4030011280	S.CER C1608 CH 1H 271J-T	B	72.3/23
C702	4030007130	S.CER C1608 CH 1H 101J-T	B	72.3/20.4
C703	4030011600	S.CER C1608 JB 1E 104K-T	B	75.8/17.3
C704	4510008970	S.ELE EEEHB1C100R	T	71.8/18.9
C705	4030007130	S.CER C1608 CH 1H 101J-T	B	68.1/19.1
C706	4030011600	S.CER C1608 JB 1E 104K-T	B	66.4/21
C707	4510009340	S.ELE EEEHA1C101WP	T	72.6/12.9
C708	4510008970	S.ELE EEEHB1C100R	T	77.8/22.4
C751	4030011280	S.CER C1608 CH 1H 271J-T	T	66.1/15.5
C752	4030007130	S.CER C1608 CH 1H 101J-T	B	73.1/10.8
C755	4030007130	S.CER C1608 CH 1H 101J-T	B	68.4/12.4
C756	4030011600	S.CER C1608 JB 1E 104K-T	B	65.3/11.1
C757	4510009340	S.ELE EEEHA1C101WP	T	60.6/9.1
C758	4510008970	S.ELE EEEHB1C100R	T	82.2/8.5
C801	4030006880	S.CER C1608 JB 1H 472K-T	B	15.5/5.8
C802	4030006880	S.CER C1608 JB 1H 102K-T	T	33.3/4.4
C901	4030006880	S.CER C1608 JB 1H 102K-T	B	85.9/8.9

[DSP BOARD]

REF NO.	ORDER NO.	DESCRIPTION	M.	H/V LOCATION
J901	6910013900	CNR IMSA-9180S-22A		
J902	6910012460	CNR IMSA-9180S-30A		
EP2	6910012350	S.BEA MMZ1608Y 102BT	B	51.6/18.6

[CHASSIS UNIT]

REF NO.	ORDER NO.	DESCRIPTION	M.	H/V LOCATION
C4501	4310000860	MYR 50 F2D 474J		
J4501	6510000370	CNR MR-DS		
J4503	6510000370	CNR MR-DS		
S4501	2260002930	SW AJ42100F		
W4502	8900014480	CBL OPC-1467		
W4503	8970024670	CBL 1.5D COAXIAL TUBE/W17D		
W4505	8900014550	CBL OPC-1560		
W4506	8900014560	CBL OPC-1561		
W4507	8900014570	CBL OPC-1562		
W4508	8970024680	CBL 1.5D COAXIAL TUBE/W17D		
W4510	8900014490	CBL OPC-1476		
W4511	8900014500	CBL OPC-1492		
W4512	8900014510	CBL OPC-1506		
W4513	8900014470	CBL OPC-1501A		
W4514	8900014520	CBL OPC-1501B		
W4515	8900015240	CBL OPC-1611		
W4520	8970024241	CBL 1.5D COAXIAL TUBE/C31		
W4522	8970024451	CBL 1.5D COAXIAL TUBE/C31		
EP4501	6910017640	E.OTH MT-483 (RED)		
EP4502	6910017650	E.OTH MT-483 (BLACK)		
EP4503	6910004900	CAP WD1911		
EP4504	6910017980	SHT TC-20EG (TO-3P)		
EP4505	6910017980	SHT TC-20EG (TO-3P)		
EP4506	6910013990	BEA 3A4-TRB-31x19x15A		
EP4507	6910013530	BEA ZCAT2035-0930A-BK		

5-2 RC-25E

[DISPLAY-A BOARD]

REF NO.	ORDER NO.	DESCRIPTION	M.	H/V LOCATION
IC8201	1140013150	S.IC HD64F2134AFA20V	B	130/60
IC8202	1110005771	S.IC S-80942CNMC-G9CT2G	B	139/72.1
IC8250	1130005721	S.IC TC7W04F (TE12L,F)	B	46.2/67.3
IC8260	1130007351	S.IC TC74HC4066AF (F)	B	40.8/54
IC8270	1110002810	S.IC NJM2070M-TE1	B	63.1/55.8
IC8280	1110002700	S.IC NJM2904M-TE1	B	22.6/79.6
IC8290	1180001071	S.IC TA7805F (TE16L,Q)	B	180.1/65.1
IC8301	1110005580	S.IC AN8010M-(E1)	B	182.1/44.6
IC8310	1180001251	S.IC TA7808F (TE16L,Q)	B	52.1/83.3
Q8251	1590001650	S.TR XP4601 (TX)	B	39.1/66.7
Q8260	1590000680	S.TR DTC114EUA T106	B	47.3/51.1
Q8280	1530002691	S.TR 2SC4116-GR (TE85R, F)	B	15.5/79.3
Q8281	1530002851	S.TR 2SC4116-BL (TE85R,F)	B	15.3/67.4
Q8282	1590000680	S.TR DTC114EUA T106	B	22.6/66.1
Q8300	1540000441	S.TR 2SD1619T-TD-E	B	44.5/42.7
Q8301	1540000441	S.TR 2SD1619T-TD-E	B	110/61.4
Q8340	1530002851	S.TR 2SC4116-BL (TE85R,F)	B	161.1/15.1
Q8341	1530002851	S.TR 2SC4116-BL (TE85R,F)	B	18.2/86.2
Q8342	1530002851	S.TR 2SC4116-BL (TE85R,F)	B	11.4/86.2
Q8343	1530002851	S.TR 2SC4116-BL (TE85R,F)	B	138.6/38.3
Q8344	1530002851	S.TR 2SC4116-BL (TE85R,F)	B	170.5/36.6
Q8345	1530002851	S.TR 2SC4116-BL (TE85R,F)	B	184.5/32.9
D8201	1750000370	S.DIO DA221 TL	B	95.2/74.9
D8203	1750000370	S.DIO DA221 TL	B	95.3/72.6
D8204	1750000550	S.DIO 1SS355 TE-17	B	28.2/20.9
D8205	1750000550	S.DIO 1SS355 TE-17	B	14.8/20.3
D8250	1750000550	S.DIO 1SS355 TE-17	B	39.1/70.2
D8280	1750000370	S.DIO DA221 TL	B	16.1/60
D8340	1750000520	S.DIO DAN222TL	B	155.4/17.9
D8701	1750000550	S.DIO 1SS355 TE-17	B	12.9/50.9
X8211	6050010501	S.XTL CR-636A (14.7456 MHz)	B	144.9/66.9
L8201	6200001831	S.COL NLV32T-100J	B	159/77.8
L8202	6200002041	S.COL NLV25T-101J	B	17/20.5
L8203	6200002041	S.COL NLV25T-101J	B	20.8/20.5
L8206	6200003950	S.COL HF50ACC 322513-T	B	161.3/86.2
L8207	6200002041	S.COL NLV25T-101J	B	17.4/4.3
L8208	6200002041	S.COL NLV25T-101J	B	15.4/16.7
L8209	6200002041	S.COL NLV25T-101J	B	26.5/10
L8210	6200002041	S.COL NLV25T-101J	B	24.4/14.9
L8270	6200003261	S.COL NLV32T-101J	B	69.4/62.5
L8286	6200005011	S.COL NLV25T-100J	B	28.9/84.8
L8290	6200003950	S.COL HF50ACC 322513-T	B	90.1/87.5
L8291	6200002041	S.COL NLV25T-101J	B	116.6/91.1
L8292	6200002041	S.COL NLV25T-101J	B	121.6/87.6
L8293	6200002041	S.COL NLV25T-101J	B	119.9/83.5
L8294	6200002041	S.COL NLV25T-101J	B	118.2/86.7
L8295	6200003241	S.COL NLV32T-221J	B	114.5/86.7
L8296	6200003241	S.COL NLV32T-221J	B	114.5/83.7
L8297	6200003950	S.COL HF50ACC 322513-T	B	96.3/81.5
L8701	6200001831	S.COL NLV32T-100J	B	12.4/35.1
R8201	7030003640	S.RES ERJ3GEYJ 473 V (47 k)	B	136.8/45.7
R8202	7030003640	S.RES ERJ3GEYJ 473 V (47 k)	B	166.5/80.5
R8203	7030003640	S.RES ERJ3GEYJ 473 V (47 k)	B	164.5/80.5
R8204	7030003640	S.RES ERJ3GEYJ 473 V (47 k)	B	170.5/80.5
R8205	7030003560	S.RES ERJ3GEYJ 103 V (10 k)	B	168.5/80.5
R8206	7030003640	S.RES ERJ3GEYJ 473 V (47 k)	B	142.2/59.1
R8207	7030003640	S.RES ERJ3GEYJ 473 V (47 k)	B	142.2/60.4
R8208	7030003650	S.RES ERJ3GEYJ 563 V (56 k)	B	139/79.5
R8209	7030003680	S.RES ERJ3GEYJ 104 V (100 k)	B	139/78.1
R8210	7030003640	S.RES ERJ3GEYJ 473 V (47 k)	B	143.5/56.4
R8211	7030003640	S.RES ERJ3GEYJ 473 V (47 k)	B	146.2/56.3
R8212	7030003640	S.RES ERJ3GEYJ 473 V (47 k)	B	146.2/54.1
R8213	7030003640	S.RES ERJ3GEYJ 473 V (47 k)	B	146.2/52.8
R8214	7030003640	S.RES ERJ3GEYJ 473 V (47 k)	B	104.2/53.9
R8215	7030003640	S.RES ERJ3GEYJ 473 V (47 k)	B	129.9/47.3
R8216	7030003640	S.RES ERJ3GEYJ 473 V (47 k)	B	138.2/81.7
R8217	7030003520	S.RES ERJ3GEYJ 472 V (4.7 k)	B	32.2/24.8
R8218	7030003440	S.RES ERJ3GEYJ 102 V (1 k)	B	123.8/43.2
R8219	7030003440	S.RES ERJ3GEYJ 102 V (1 k)	B	123.3/39.4
R8220	7030003440	S.RES ERJ3GEYJ 102 V (1 k)	B	119.9/40
R8221	7030003440	S.RES ERJ3GEYJ 102 V (1 k)	B	127.2/43.3
R8222	7030003440	S.RES ERJ3GEYJ 102 V (1 k)	B	10.2/65.5
R8223	7030003640	S.RES ERJ3GEYJ 473 V (47 k)	B	12.2/65.2
R8224	7030003640	S.RES ERJ3GEYJ 473 V (47 k)	B	127.5/39.4
R8225	7030003590	S.RES ERJ3GEYJ 183 V (18 k)	B	127.5/38
R8226	7030003470	S.RES ERJ3GEYJ 182 V (1.8 k)	B	48.2/61.8
R8227	7030003560	S.RES ERJ3GEYJ 103 V (10 k)	B	46/61
R8228	7030003680	S.RES ERJ3GEYJ 104 V (100 k)	B	127.5/36.7
R8229	7030003560	S.RES ERJ3GEYJ 103 V (10 k)	B	136.9/81.7
R8230	7030003640	S.RES ERJ3GEYJ 473 V (47 k)	B	132.7/29.2

M.=Mounted side (T: Mounted on the Top side, B: Mounted on the Bottom side)

S.=Surface mount





**[DISPLAY-A BOARD]**

REF NO.	ORDER NO.	DESCRIPTION	M.	H/V LOCATION
DS8347	5040002310	S.LED SML-311YTT86	T	170.5/36.4
DS8348	5040002310	S.LED SML-311YTT86	T	184.5/76.9
DS8349	5040002310	S.LED SML-311YTT86	T	184.5/49.9
DS8350	5040002310	S.LED SML-311YTT86	T	184.5/36.4
EP8205	6910012350	S.BEA MMZ1608Y 102BT	B	187.9/17
EP8210	6910012350	S.BEA MMZ1608Y 102BT	B	108.9/52.1
EP8211	6910012350	S.BEA MMZ1608Y 102BT	B	112.5/54.6
EP8212	6910012350	S.BEA MMZ1608Y 102BT	B	105.9/50.9
EP8213	6910012350	S.BEA MMZ1608Y 102BT	B	114.1/54.6
EP8214	6910012350	S.BEA MMZ1608Y 102BT	B	108.9/49.3
EP8215	6910012350	S.BEA MMZ1608Y 102BT	B	115.7/54.6
EP8216	6910012350	S.BEA MMZ1608Y 102BT	B	105.9/48.1
EP8217	6910012350	S.BEA MMZ1608Y 102BT	B	113.7/48.3
EP8218	6910012350	S.BEA MMZ1608Y 102BT	B	108.9/46.5
EP8219	6910012350	S.BEA MMZ1608Y 102BT	B	115.4/48.3
EP8220	6910012350	S.BEA MMZ1608Y 102BT	B	116.1/45.7
EP8221	6910012350	S.BEA MMZ1608Y 102BT	B	118.2/46.8
EP8222	6910012350	S.BEA MMZ1608Y 102BT	B	116.1/44.1
EP8223	6910012350	S.BEA MMZ1608Y 102BT	B	119.8/46.8
EP8292	6910012350	S.BEA MMZ1608Y 102BT	B	111/89.2
EP8293	6910012350	S.BEA MMZ1608Y 102BT	B	110.9/91.1
EP8294	6910012350	S.BEA MMZ1608Y 102BT	B	111.1/87.1
EP8295	6910012350	S.BEA MMZ1608Y 102BT	B	111.9/85
EP8296	6910012350	S.BEA MMZ1608Y 102BT	B	105.3/88.3

**[FRONT-A UNIT]**

REF NO.	ORDER NO.	DESCRIPTION	M.	H/V LOCATION
W8001	8900014540	CBL OPC-1493		
W8005	8900008860	CBL OPC-875		

**[SENSOR-A BOARD]**

REF NO.	ORDER NO.	DESCRIPTION	M.	H/V LOCATION
S8801	2250000220	ECR TP90N937E20-15F-1540		
S8802	2250000220	ECR TP90N937E20-15F-1540		

**[VR-A BOARD]**

REF NO.	ORDER NO.	DESCRIPTION	M.	H/V LOCATION
R8901	7210002360	VAR TP96N97-15F-10KB-1301		

**[CONNECT-A BOARD]**

REF NO.	ORDER NO.	DESCRIPTION	M.	H/V LOCATION
IC8240	1140010010	S.IC HD66421TBOL	T	34.5/18
L8220	6200001831	S.COL NLV32T-100J	B	51.9/6.3
L8221	6200001831	S.COL NLV32T-100J	B	52/2.7
R8241	7030003830	S.RES ERJ3GEYJ 185 V (1.8 M)	B	50/8.5
R8242	7030003840	S.RES ERJ3GEYJ 225 V (2.2 M)	B	38.3/17.5
R8243	7030003640	S.RES ERJ3GEYJ 473 V (47 k)	B	29.7/18.9
R8244	7030003640	S.RES ERJ3GEYJ 473 V (47 k)	B	32.8/19
R8245	7030003640	S.RES ERJ3GEYJ 473 V (47 k)	B	35.1/18.3
R8246	7030003830	S.RES ERJ3GEYJ 185 V (1.8 M)	B	47.3/8
C8230	4030011600	S.CER C1608 JB 1E 104K-T	B	55.5/2.7
C8231	4030011600	S.CER C1608 JB 1E 104K-T	B	55.5/6.3
C8232	4550007660	S.TAN F931E105MAABMA	B	58.4/17
C8233	4550007660	S.TAN F931E105MAABMA	B	54.1/15.6
C8234	4550007660	S.TAN F931E105MAABMA	B	49.7/18.6
C8235	4550007660	S.TAN F931E105MAABMA	B	44.8/17
C8236	4550007660	S.TAN F931E105MAABMA	B	41.3/17
C8237	4030011600	S.CER C1608 JB 1E 104K-T	B	41.4/8.6
J8220	6510022541	S.CNR 20FMN-BMTTR-A-TBT (LF) (SN)	B	34.5/4.5
DS8220	5030002280	LCD HLC7700-018800		

M.=Mounted side (T: Mounted on the Top side, B: Mounted on the Bottom side)

S.=Surface mount

# SECTION 6 MECHANICAL PARTS AND DISASSEMBLY

## 6-1 IC-M801E

### [CHASSIS PARTS]

REF. NO.	ORDER NO.	DESCRIPTION	QTY.
J4501	6510000370	Connector MR-DS	1
J4503	6510000370	Connector MR-DS	1
S4501	2260002930	Switch AJ42100F	1
W4502	8900014480	Cable OPC-1467	1
W4510	8900014490	Cable OPC-1476	1
W4511	8900014500	Cable OPC-1492	1
W4515	8900015240	Cable OPC-1611	1
EP4501	6910017640	MT-483 (RED)	1
EP4502	6910017650	MT-483 (BLACK)	1
EP4503	6910004900	Cap WD1911	1
EP4504	6910017980	Sheet TC-20EG	1
EP4505	6910017980	Sheet TC-20EG	1
EP4507	6910013530	Bead ZCAT2035-0930A-BK	1
MP4501	8110008610	1958 U-cover	1
MP4502	8110008620	1958 L-cover	1
MP4503	8930068160	1958 packing	1
MP4506	8930068950	1958 A-connector seal	1
MP4507	8930068900	1958 U-B plate	1
MP4508	8930068890	1958 L-B plate	1
MP4510	8930068150	1958 terminal plate	2
MP4516	8930054280	2440 vent. sheet	1
MP4517	8930034300	1542 ant seal	2
MP4518	8930037001	1691 earth plate-1 Y266A	2
MP4521	8930037030	1562 stand-off	6
MP4524	8930053472	Thermally sheet (R)-2 TC200HS	1
MP4525	8930063250	Thermally sheet (AS) TC-600HS-1.4	1
MP4526	8930068830	Thermally sheet (AY) TC-700HS-1.4	1
MP4527	8810001510	Screw PH B0 M3 × 8 SUS	4
MP4528	8810009721	Setscrew H M3 × 8 SUS SSBC	2
MP4529	8810009650	Screw FH BT M3 × 8 NI-ZU	26
MP4530	8810009650	Screw FH BT M3 × 8 NI-ZU	12
MP4531	8810008660	Screw PH BT M3 × 8 NI-ZU	10
MP4532	8810008660	Screw PH BT M3 × 8 NI-ZU	10
MP4533	8810008660	Screw PH BT M3 × 8 NI-ZU	2
MP4534	8810003860	Setscrew A M4 × 8	2
MP4535	8810003380	Setscrew C M3 × 10	2
MP4536	8810003380	Setscrew C M3 × 10	2
MP4537	8810007230	Setscrew H M3 × 8	4
MP4538	8810003860	Setscrew A M4 × 8	5
MP4539	8810007230	Setscrew H M3 × 8	2
MP4540	8810007230	Setscrew H M3 × 8	2
MP4541	8930068200	1958 CA rubber	2
MP4542	8930068210	1958 CB rubber	1
MP4543	8930068340	1958 U-A plate	1
MP4544	8930068130	1958 L-A plate	1
MP4545	8930068220	1958 CA plate	2
MP4546	8930068230	1958 CB plate	1
MP4556	8810008660	Screw PH BT M3 × 8 NI-ZU	4
MP4557	8810008660	Screw PH BT M3 × 8 NI-ZU	8
MP4558	8810008660	Screw PH BT M3 × 8 NI-ZU	10
MP4559	8810007230	Setscrew H M3 × 8	2
MP4560	8810007230	Setscrew H M3 × 8	1
MP4561	8810007230	Setscrew H M3 × 8	1
MP4562	8810007230	Setscrew H M3 × 8	2
MP4563	8810008980	Hex head bolt M4 × 8 SUS (+)	1
MP4564	8850000170	Flat washer M4 SUS	2
MP4565	8850000490	Spring washer M4 SUS	1
MP4566	8810009080	Screw truss M3 × 3 SUS	2
MP4567	8810009080	Screw truss M3 × 3 SUS	4
MP4570	8930068810	Thermally sheet (AW) TC-20EG	1
MP4571	8930068820	Thermally sheet (AX) TC-600HS-1.4	1
MP4574	8930068510	1958 terminal rubber	2

### [CHASSIS PARTS]

REF. NO.	ORDER NO.	DESCRIPTION	QTY.
MP4575	8930068940	1958 TR plate	1
MP4577	8930069000	1958 TR clip	1
MP4580	8820001410	Cap bolt M8 × 25 SUS M600	4
MP4581	8850002670	Flat washer M8 (8 × 16 × 1.2) SUS	4
MP4582	8850000520	Spring washer M8 SUS	4
MP4583	8810009060	Screw FH M3 × 6 ZK	1
MP4584	8810008800	Screw PH UNC NO.4 × 4 SUS	4
MP4585	8810008800	Screw PH UNC NO.4 × 4 SUS	2
MP4586	8930068800	Sponge (IU)	1
MP4587	8930069610	Sponge (IV)	1
MP4588	8930069630	Shield sponge (AW)	2
MP4589	8930069640	Shield sponge (AX)	2
MP4590	8930059330	Shield sponge (W)	4
MP4591	8510017630	1958 PA shield plate	1
MP4592	8930069580	4593 thermally sheet (BA)	1
MP4593	8860000110	4593 earth lug	1

### [MAIN UNIT]

REF. NO.	ORDER NO.	DESCRIPTION	QTY.
J9001	6510023120	Connector CD6109SA1J0	1
J9051	6510023120	Connector CD6109SA1J0	1
J9151	6510023210	Connector CD6125SA1J0	1
BT1	3020000110	Lithium battery CR2032	1
MP51	8930014140	Earth spring (D)	1
MP201	8510014610	2429 mix case	1
MP202*	8930005320	Filter spacer	1
MP231*	8930005200	Crystal seat	2
MP301	8510000180	117 shield plate	1
MP303*	8930005320	Filter spacer	2
MP701	8510011970	2177 OSC case	1
MP702	8510014600	2429 OSC cover	1
MP1501	8510013140	2241 DC-A case	1

### [DSP BOARD]

REF. NO.	ORDER NO.	DESCRIPTION	QTY.
MP1	8510014650	2429 DSP case	1
MP5	8930059330	Shield sponge (W)	1
MP6	8930070380	Sponge (JG)	1

### [PLL UNIT]

REF. NO.	ORDER NO.	DESCRIPTION	QTY.
MP5801*	8510006941	DTMF shield case-1	1
MP5901*	8510006941	DTMF shield case-1	1

### [REG-DC BOARD]

REF. NO.	ORDER NO.	DESCRIPTION	QTY.
MP1*	8510011410	1981 CTRL plate	1
MP2*	8510011410	1981 CTRL plate	1

### [DRIVER BOARD]

REF. NO.	ORDER NO.	DESCRIPTION	QTY.
MP6851*	8410002480	2429 PA heatsink	1

\*: Refer to SECTION 8 BOARD LAYOUTS.

**[ACCESSORIES]**

REF. NO.	ORDER NO.	DESCRIPTION	QTY.
F4001	5210000061	Fuse FGB 5A PBF	2
J4001	6510002030	Connector 1380TL	4
P4001	6510001930	Connector 1490P1	1
W4001	8900014460	Cable OPC-1475	1
W4002	8900012420	Cable OPC-1278	1
MC4001	Optional product	Microphone HS-98	1
MP4001	8810003490	Hex head bolt M6 × 15 SUS	6
MP4002	8850000200	Flat washer M6 (6 × 20 × 1.5) SUS	6
MP4003	8850000510	Spring washer M6 SUS	6
MP4004	8810003500	Hex head bolt M6 × 50 SUS	6
MP4005	8830000260	Nut M6 SUS	6
MP4006	8850000200	Flat washer M6 (6 × 20 × 1.5) SUS	12
MP4007	8850000510	Spring washer M6 SUS	12
MP4008	8010020380	1958 angle	2
MP4009	8930036560	1632 cushion rubber	4
MP4010	6950000460	Weatherproof cap	2

**6-2 SP-24E**

**[CHASSIS PARTS]**

REF. NO.	ORDER NO.	DESCRIPTION	QTY.
W1	8900014580	Cable OPC-1507	1
SP1	2510001170	Speaker 077P0401	1
MP1	8210018780	2431 front panel assembly	1
MP2	8210018790	2431 rear panel assembly	1
MP7	8810004430	Screw PH M3 × 6 ZK	4
MP8	8930057640	Insulation plate GW	1
MP10	8930068190	2431 packing	1

**[ACCESSORIES]**

REF. NO.	ORDER NO.	DESCRIPTION	QTY.
MP1	8010018870	2546 bracket	1
MP2	8810001490	Screw PH A M5 × 20 SUS	2
MP3	8850000500	Spring washer M5 SUS	2
MP4	8850000180	Flat washer M5 SUS	2
MP5	8610010561	2040 knob bolt-1	2

**Screw abbreviations**

B0, BT: Self-tapping  
 PH: Pan head    FH: Flat head  
 ZK: Black        SUS: Stainless  
 NI-ZU: Nickel-Zinc

**6-3 RC-25E**

**[FRONT-A PARTS]**

REF. NO.	ORDER NO.	DESCRIPTION	QTY.
W8001	8900014540	Cable OPC-1493	1
MP8001	8210022420	2545 front panel (B) assembly	1
MP8002	8210018731	2545 rear panel assembly -1	1
MP8004	8210018620	2545 reflector	1
MP8005	8930067430	2545 20-key (B)	1
MP8006	8930067420	2545 3-key (B)	1
MP8007	8930057480	2545 LCD holder	1
MP8008	8930057490	2545 LCD filter	1
MP8009	8830001630	VR Nut (P)	1
MP8016	8610010851	Knob N279-1	1
MP8017	8610010861	Knob N280-1	2
MP8020	8810004430	Screw PH M3 × 6 ZK	8
MP8022	8810008660	Screw PH BT M3 × 8 NI-ZU	9
MP8023	8930057110	2545 phone cap	1
MP8025	8930058271	2577 F-packing-1	1

**[DISPLAY-A BOARD]**

REF. NO.	ORDER NO.	DESCRIPTION	QTY.
J8701	6510022440	Connector LTW-8MP-C	1
J8702	6450001630	Connector HSJ1406-01-050	1
MP8201	8510014560	2545 shield case	1

**[SENSOR-A BOARD]**

REF. NO.	ORDER NO.	DESCRIPTION	QTY.
S8801	2250000220	Encoder TP90N937E20-15F-1540	1
S8802	2250000220	Encoder TP90N937E20-15F-1540	1

**[VR-A BOARD]**

REF. NO.	ORDER NO.	DESCRIPTION	QTY.
R8901	7210002360	Variable resistor TP96N97-15F-10KB-1301	1

**[CONNECT-A BOARD]**

REF. NO.	ORDER NO.	DESCRIPTION	QTY.
DS8220	5030002320	M802 LCD assembly C	1

**[ACCESSORIES]**

REF. NO.	ORDER NO.	DESCRIPTION	QTY.
W8101	8900014530	Cable OPC-1466	1
MP8101	8010018860	2455 bracket	1
MP8102	8810001490	Screw PH A M5 × 20 SUS	4
MP8103	8850000500	Spring washer M5 SUS	4
MP8104	8850000180	Flat washer M5 SUS	4
MP8105	8610010561	2040 knob bolt-1	2

**IC-M801E**

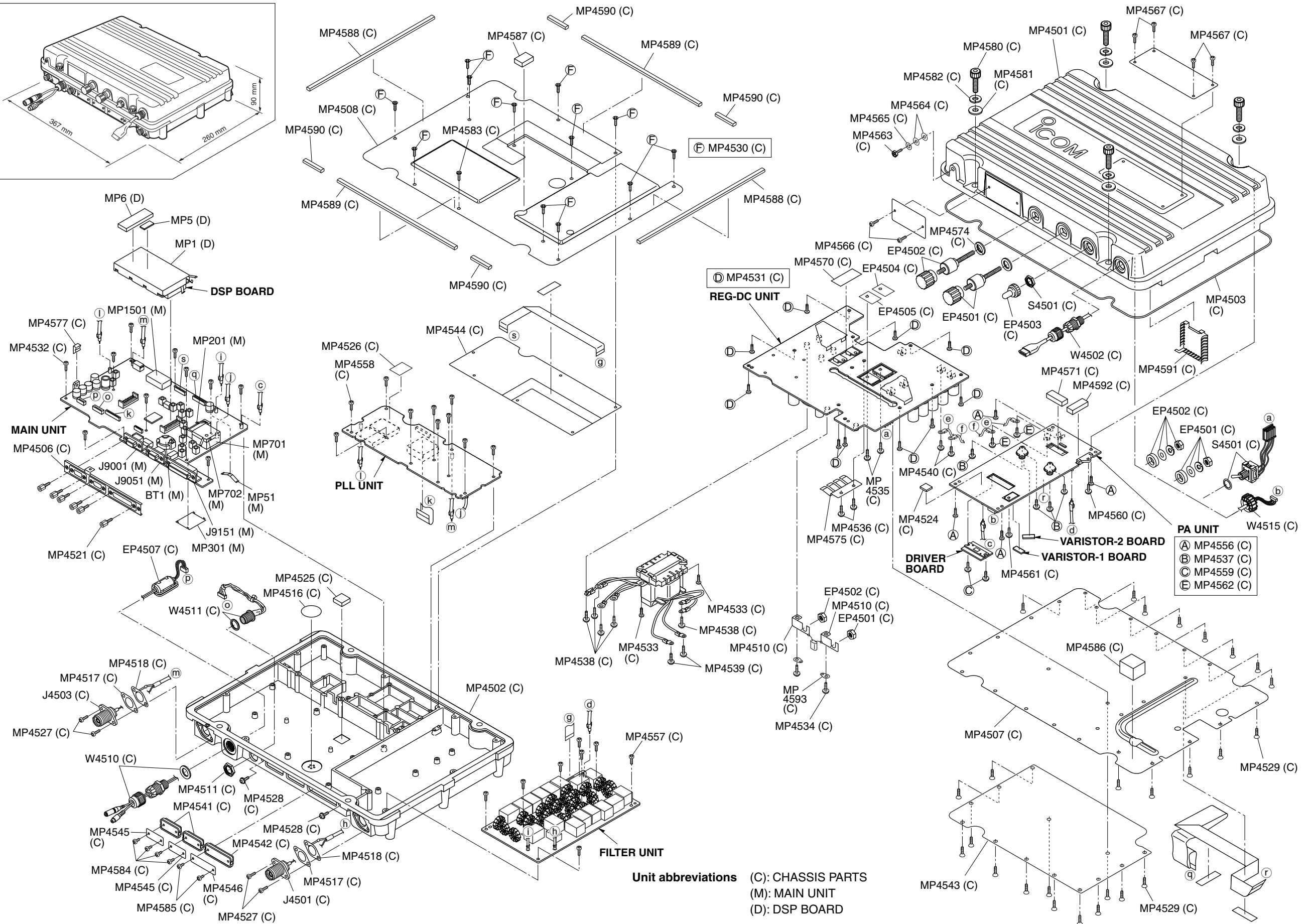
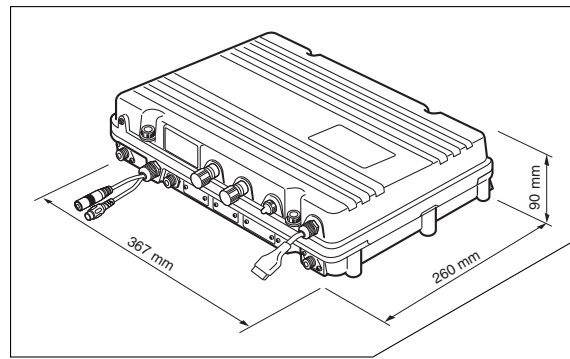

**Unit abbreviations** (C): CHASSIS PARTS  
 (M): MAIN UNIT  
 (D): DSP BOARD

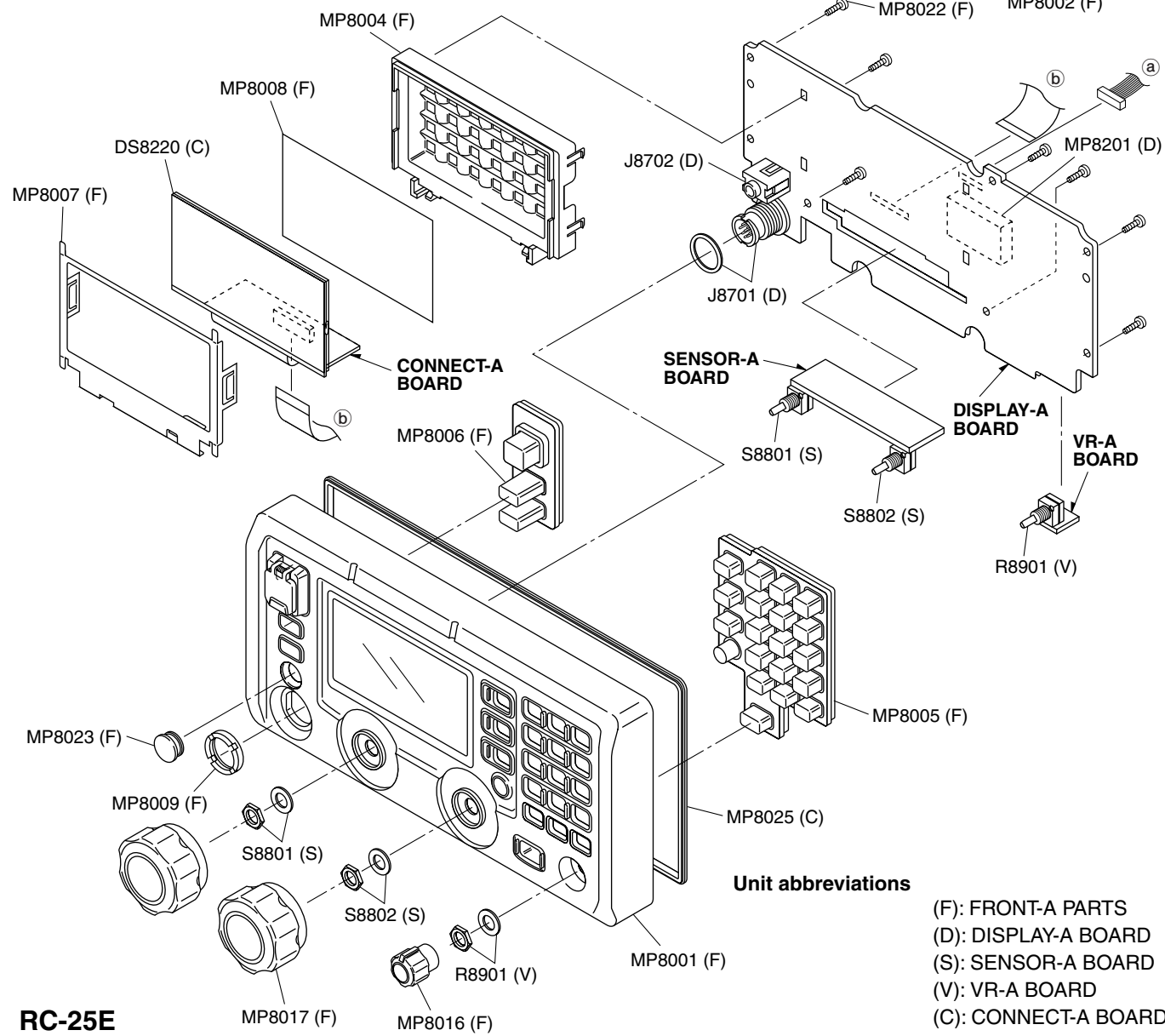
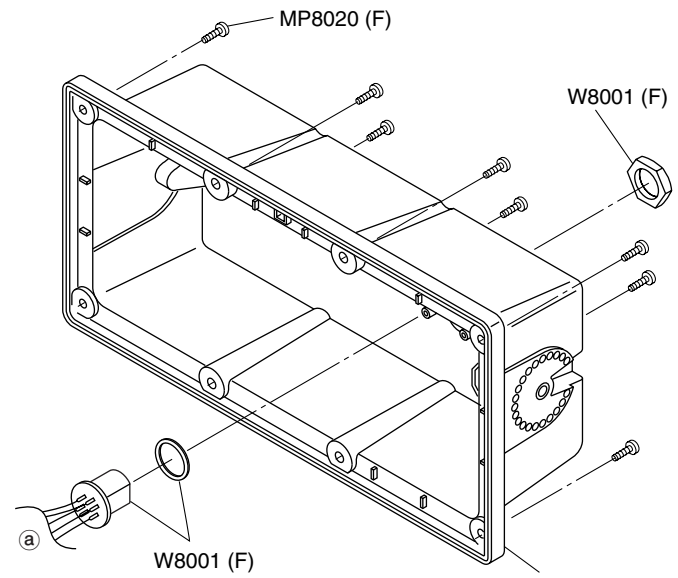
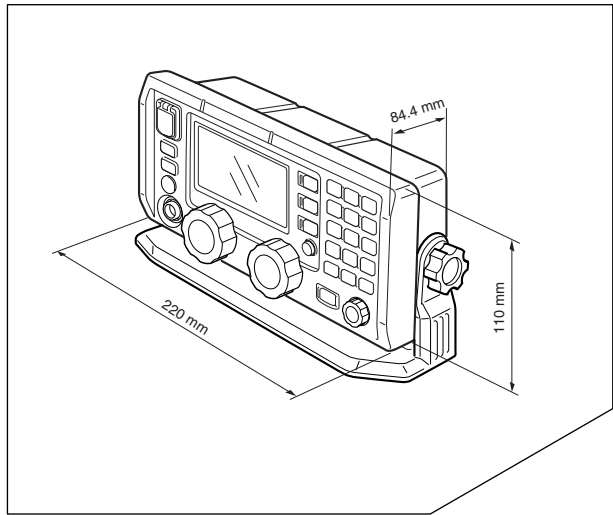

**RC-25E**

**Unit abbreviations**

- (F): FRONT-A PARTS
- (D): DISPLAY-A BOARD
- (S): SENSOR-A BOARD
- (V): VR-A BOARD
- (C): CONNECT-A BOARD

**SP-24E**

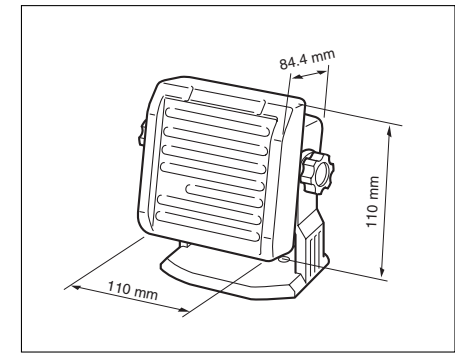
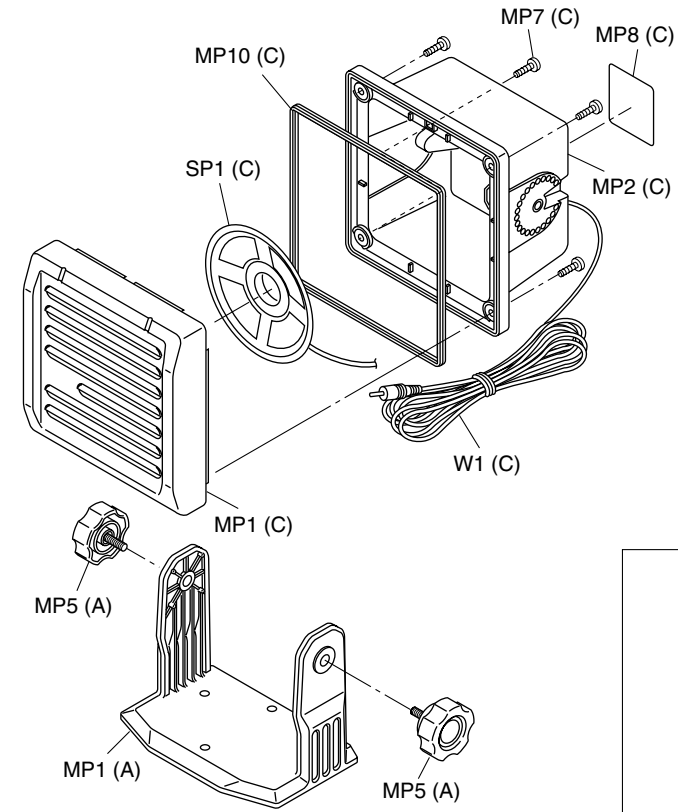

**Unit abbreviations** (C): CHASSIS PARTS  
(A): ACCESSORY PARTS

**ACCESSORIES**

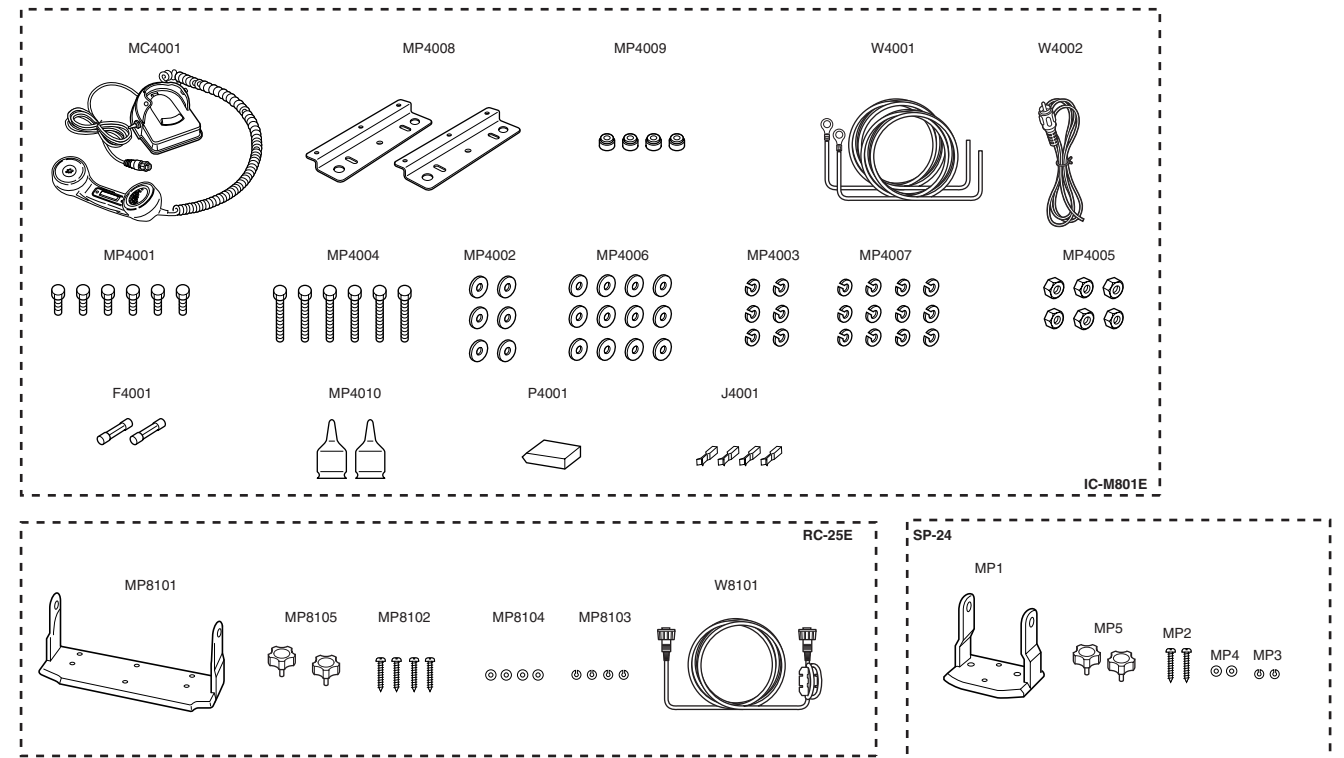





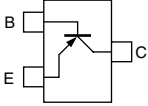
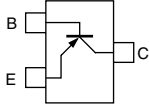
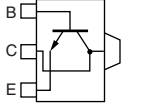
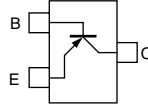
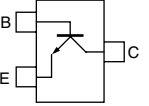
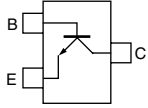
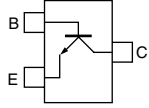
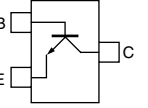
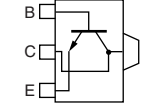
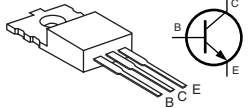
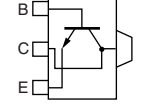
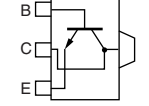
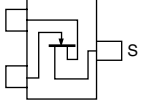
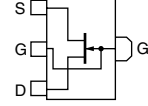
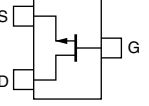
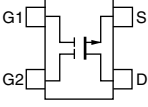
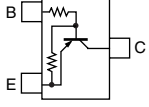
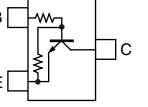
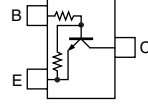
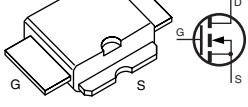
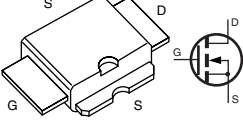
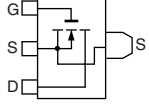
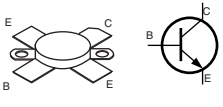
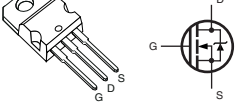
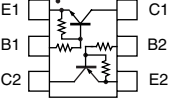
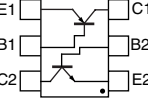



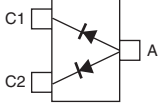
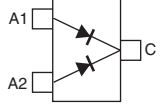
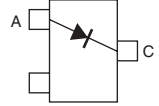
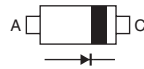
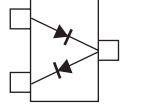
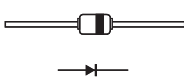
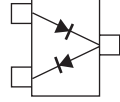
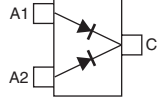
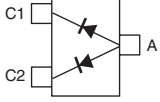
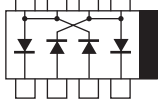
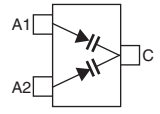

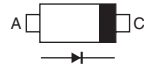
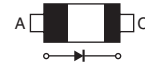
# SECTION 7 SEMICONDUCTOR INFORMATION

## • TRANSISTORS AND FET'S

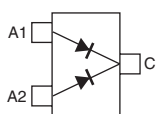
<p><b>2SA1037AK S</b> (Symbol: FS)</p> 	<p><b>2SA1162 GR</b> (Symbol: SG)</p> 	<p><b>2SA1213 Y</b> (Symbol: NY)</p> 	<p><b>2SA1586 GR</b> (Symbol: SG)</p> 	<p><b>2SC4116 BL</b> (Symbol: LL)</p> 
<p><b>2SC4116 GR</b> (Symbol: LG)</p> 	<p><b>2SC4213 B</b> (Symbol: AB)</p> 	<p><b>2SC4215 O</b> (Symbol: QO)</p> 	<p><b>2SC4673 D TD</b> (Symbol: CO)</p> 	<p><b>2SD1585 K</b> (Symbol: None)</p> 
<p><b>2SD1619 TD</b> (Symbol: DB)</p> 	<p><b>2SD1619 T TD</b> (Symbol: DB)</p> 	<p><b>2SK210 GR</b> (Symbol: YG)</p> 	<p><b>2SK2171 4 TD</b> (Symbol: KM)</p> 	<p><b>2SK508 K52 T2B</b> (Symbol: K52)</p> 
<p><b>3SK131 T2 MAS</b> (Symbol: V11)</p> 	<p><b>DTA114EUA T106</b> (Symbol: 16)</p> 	<p><b>DTC114EUA T106</b> (Symbol: 24)</p> 	<p><b>DTC144EUA T106</b> (Symbol: 26_)</p> 	<p><b>PD55003</b> (Symbol: PD55003)</p> 
<p><b>PD55015</b> (Symbol: PD55015)</p> 	<p><b>RD01MUS1</b> (Symbol: K2)</p> 	<p><b>SD1487</b> (Symbol: SD1487)</p> 	<p><b>STP120NF10</b> (Symbol: P120NF10)</p> 	<p><b>XP4312</b> (Symbol: 7T)</p> 
<p><b>XP4601</b> (Symbol: 5C)</p> 				

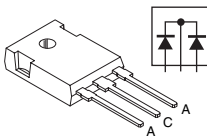
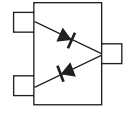
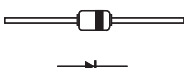
• DIODES

<p><b>1SS300</b> (Symbol: A3)</p> 	<p><b>1SS301</b> (Symbol: B3)</p> 	<p><b>1SS322</b> (Symbol: A9)</p> 	<p><b>1SS355</b> (Symbol: A)</p> 	<p><b>1SS375-TL</b> (Symbol: FH)</p> 
<p><b>D1NL20U</b> (Symbol: 2U)</p> 	<p><b>DA221 TL</b> (Symbol: K)</p> 	<p><b>DAN222TL</b> (Symbol: N)</p> 	<p><b>DAP222 TL</b> (Symbol: P)</p> 	<p><b>HSB88WSTR</b> (Symbol: Silver line)</p> 
<p><b>KV1770S</b> (Symbol: C7)</p> 	<p><b>MA2S111</b> (Symbol: A)</p> 	<p><b>MA2S728</b> (Symbol: B)</p> 	<p><b>MA30-(TX)</b> (Symbol: 3B)</p> 	<p><b>MA338</b> (Symbol: 6H)</p> 
<p><b>MA729</b> (Symbol: 2B)</p> 	<p><b>MA77</b> (Symbol: 4B)</p> 	<p><b>MA8051 M</b> (Symbol: 5-1)</p> 	<p><b>MA8091 M</b> (Symbol: 9-1)</p> 	<p><b>MA80WK</b> (Symbol: M1Y)</p> 
<p><b>MA8150 M</b> (Symbol: 15-)</p> 	<p><b>MUR3020WT</b> (Symbol: U3020)</p> 	<p><b>RB706F-40 T106</b> (Symbol: 3J)</p> 	<p><b>S3V60</b> (Symbol: None)</p> 	<p><b>UX9401F-STD/TR</b> (Symbol: None)</p> 



# SECTION 8 BOARD LAYOUTS

8-1 RC-25E  
8-1-1 DISPLAY-A BOARD  
• TOP VIEW

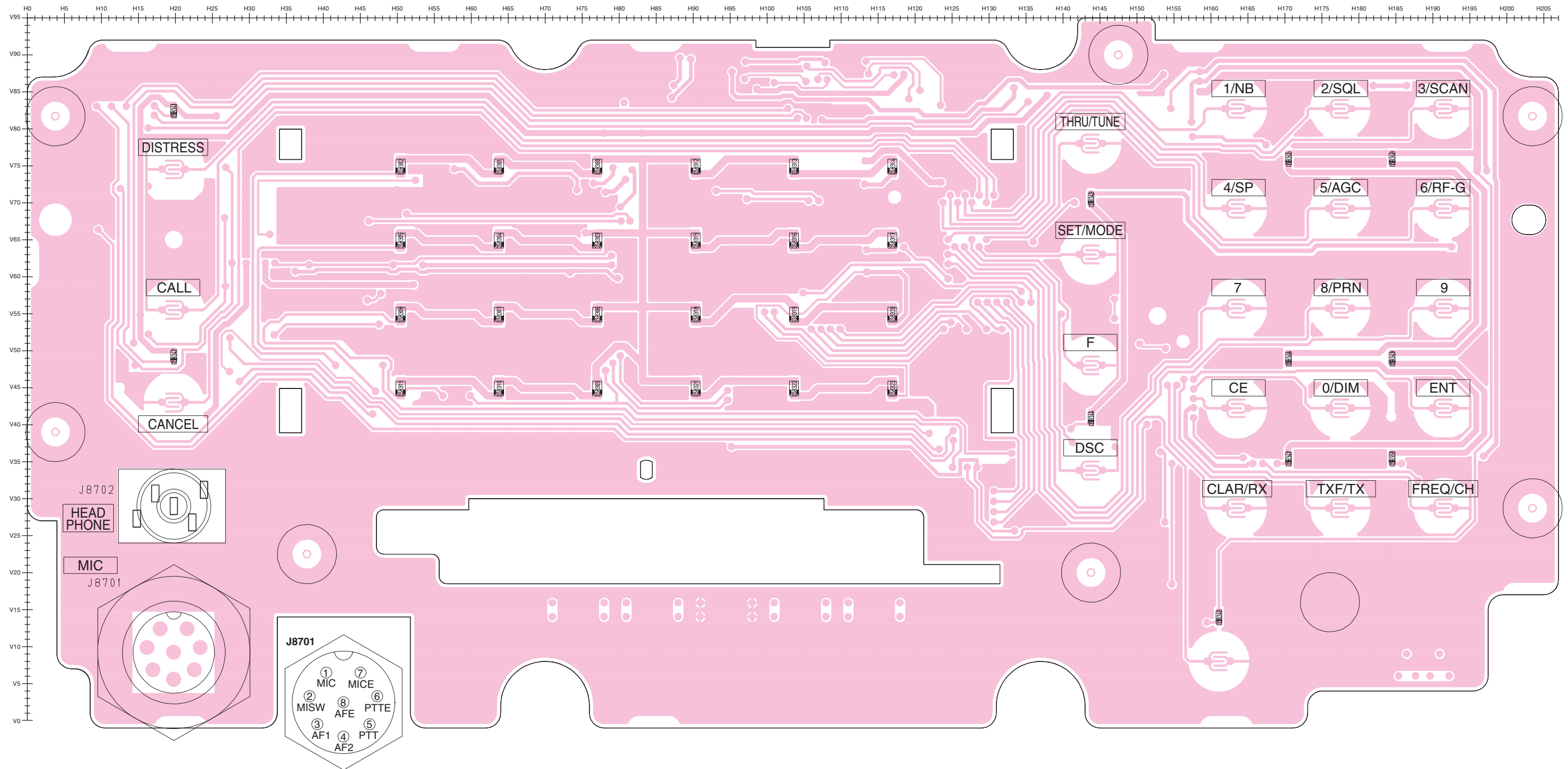

• BOTTOM VIEW (DISPLAY-A BOARD)

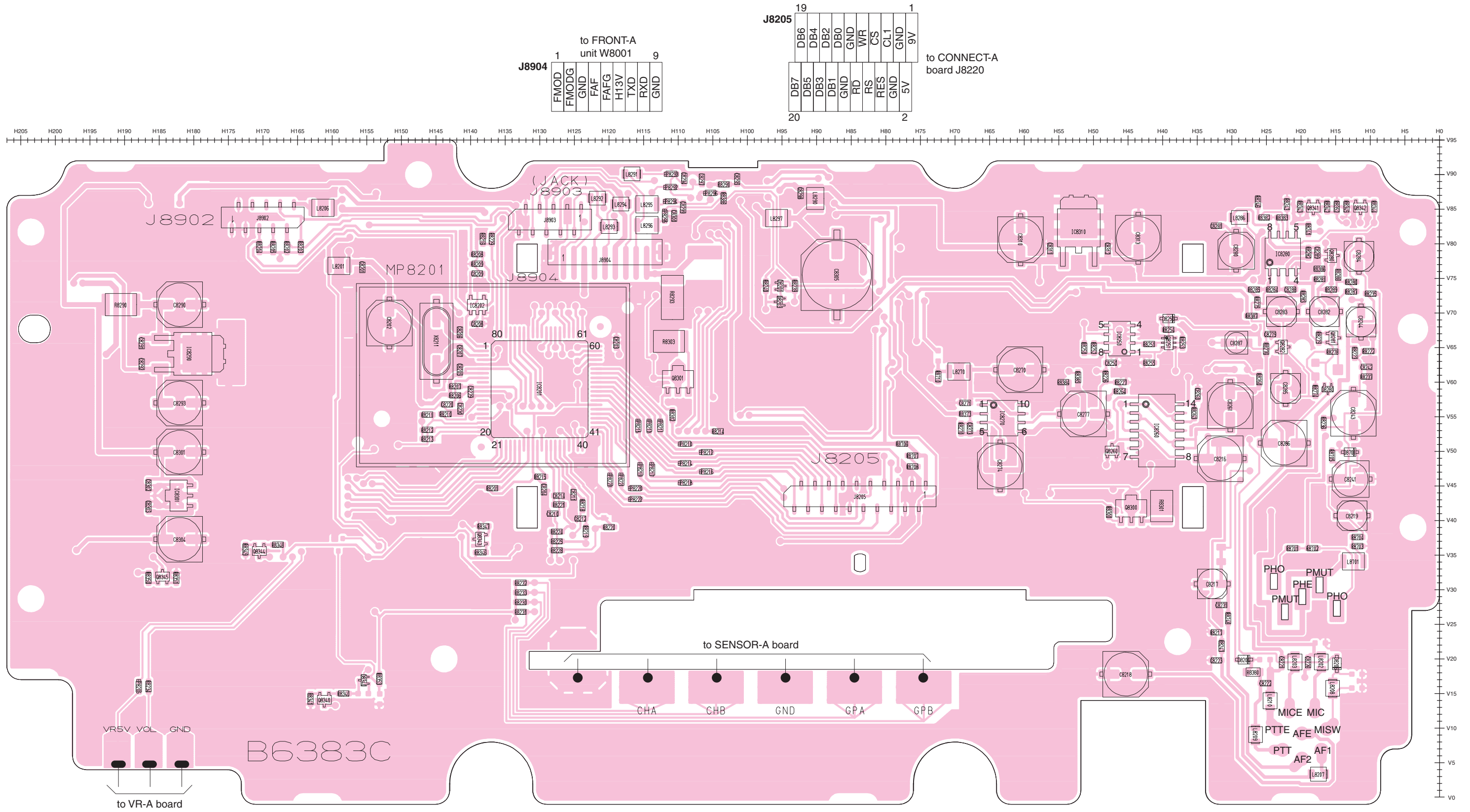

**8-1-2 CONNECT-A BOARD**  
• TOP VIEW

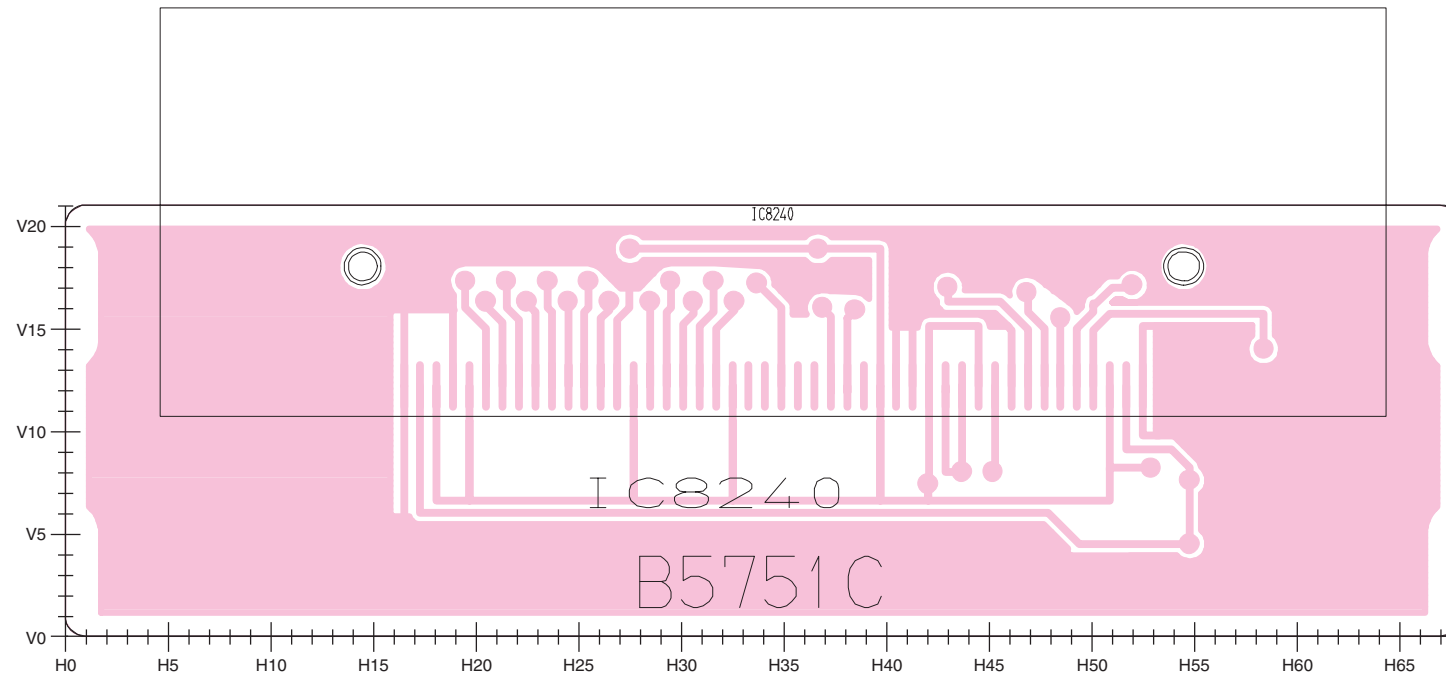

**8-1-3 SENSOR-A BOARD**

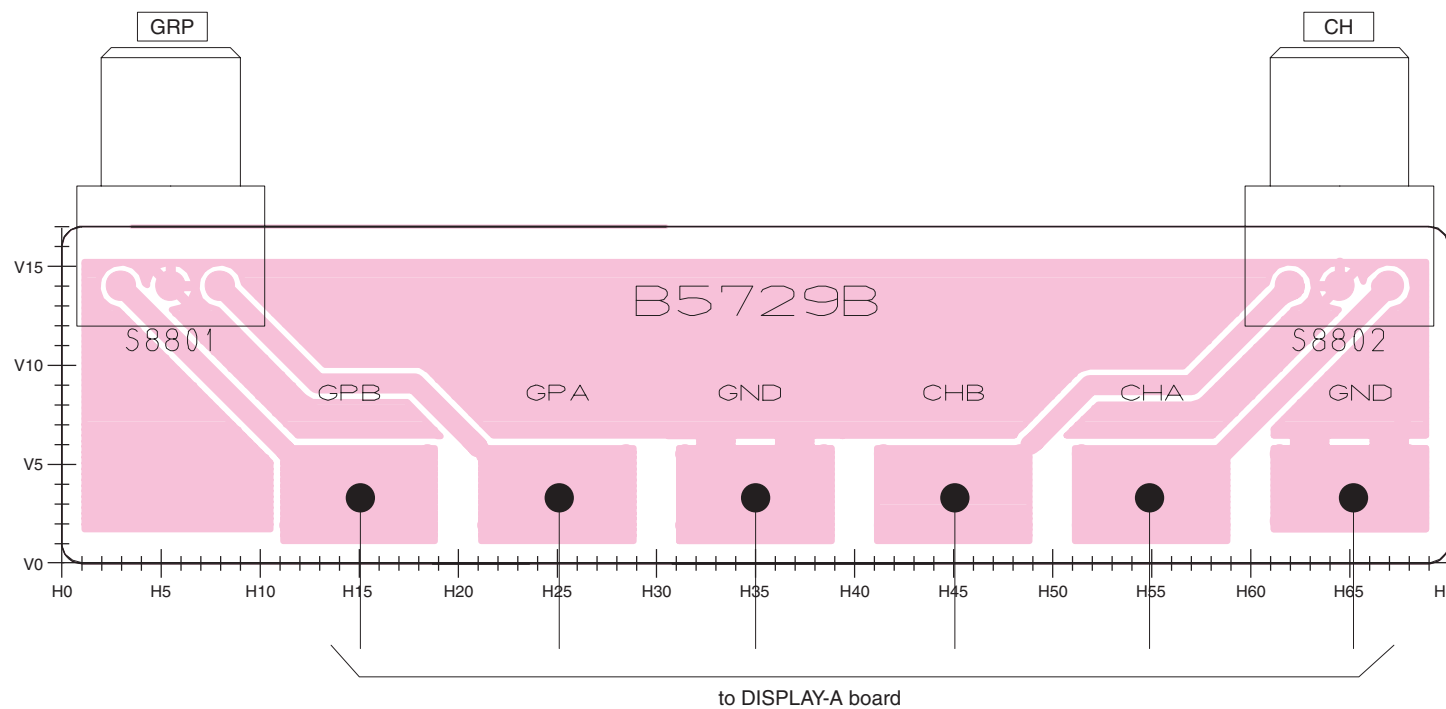

to DISPLAY-A board

**8-2 IC-M801E**  
**8-2-1 DSP BOARD**  
• TOP VIEW

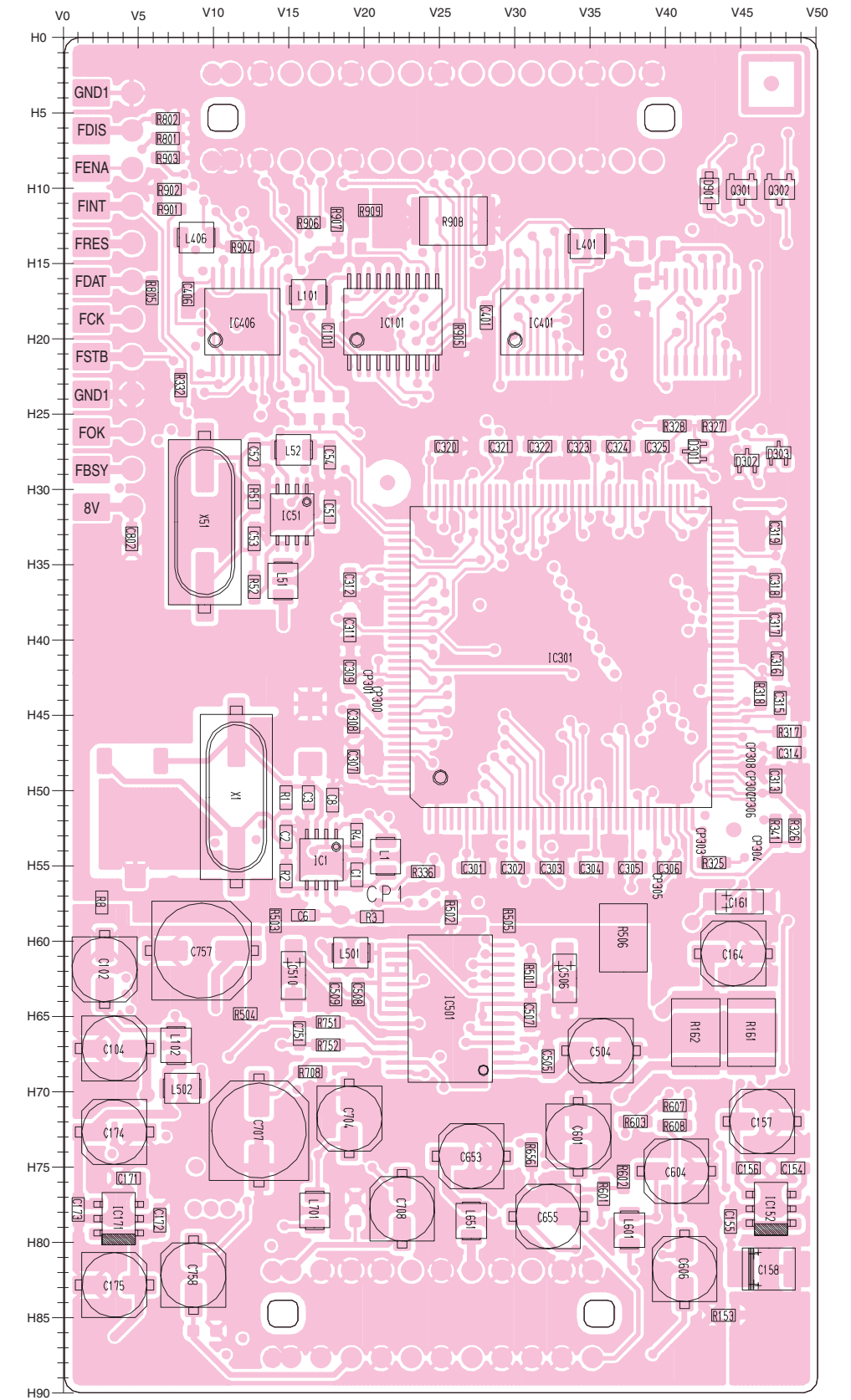



**8-2-2 MAIN UNIT**  
**• TOP VIEW**

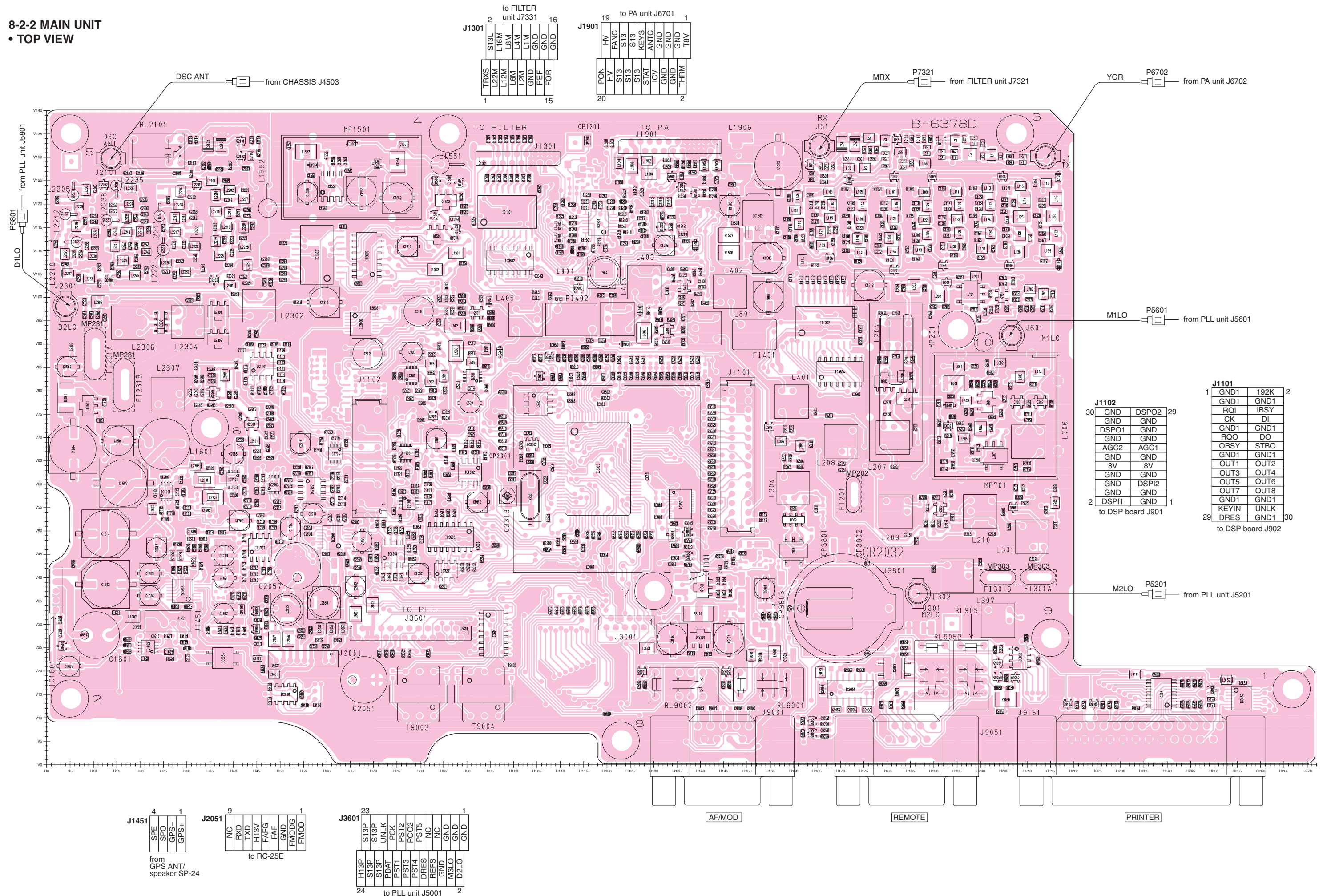

to FILTER unit J7331

J1301	2	S13L	16
		L22M	
		L12M	
		L6M	
		L2M	
		L1M	
		GND	
		REF	
		FOR	
	1		15

to PA unit J6701

J1901	19	HV	1
		FANC	
		S13	
		S13	
		S13	
		KEYS	
		STAT	
		ICV	
		ANTC	
		GND	
		GND	
		GND	
		T8V	
	20		2

J1101	1	GND1	192K	2
		GND1	GND1	
		RQ1	IBSY	
		CK	DI	
		GND1	GND1	
		RQ0	DO	
		OBSY	STBO	
		GND1	GND1	
		OUT1	OUT2	
		OUT3	OUT4	
		OUT5	OUT6	
		OUT7	OUT8	
		GND1	GND1	
		KEYIN	UNLK	
		DRES	GND1	30
				to DSP board J902

J1102	30	GND	DSPO2	29
		GND	GND	
		DSPO1	GND	
		GND	GND	
		AGC2	AGC1	
		GND	GND	
		8V	8V	
		GND	GND	
		GND	DSP12	
		GND	GND	
	2	DSP11	GND	1
				to DSP board J901

J1451

4	SPE	1
	SPO	
	GPS-	
	GPS+	

from GPS ANT/speaker SP-24

J2051

9	NC	1
	RXD	
	TXD	
	H13V	
	FAFG	
	FAF	
	GND	
	FMODG	
	FMOD	

to RC-25E

J3601

23	S13P	1
	S13P	
	S13P	
	PDAT	
	UNLK	
	PCK	
	PST1	
	PST2	
	PCO2	
	PST4	
	PST5	
	DRES	
	NC	
	NC	
	GND	
	M3LO	
	GND	
	D2LO	
	GND	
24		2

to PLL unit J5001

[AF/MOD]

[REMOTE]

[PRINTER]

• BOTTOM VIEW (MAIN UNIT)

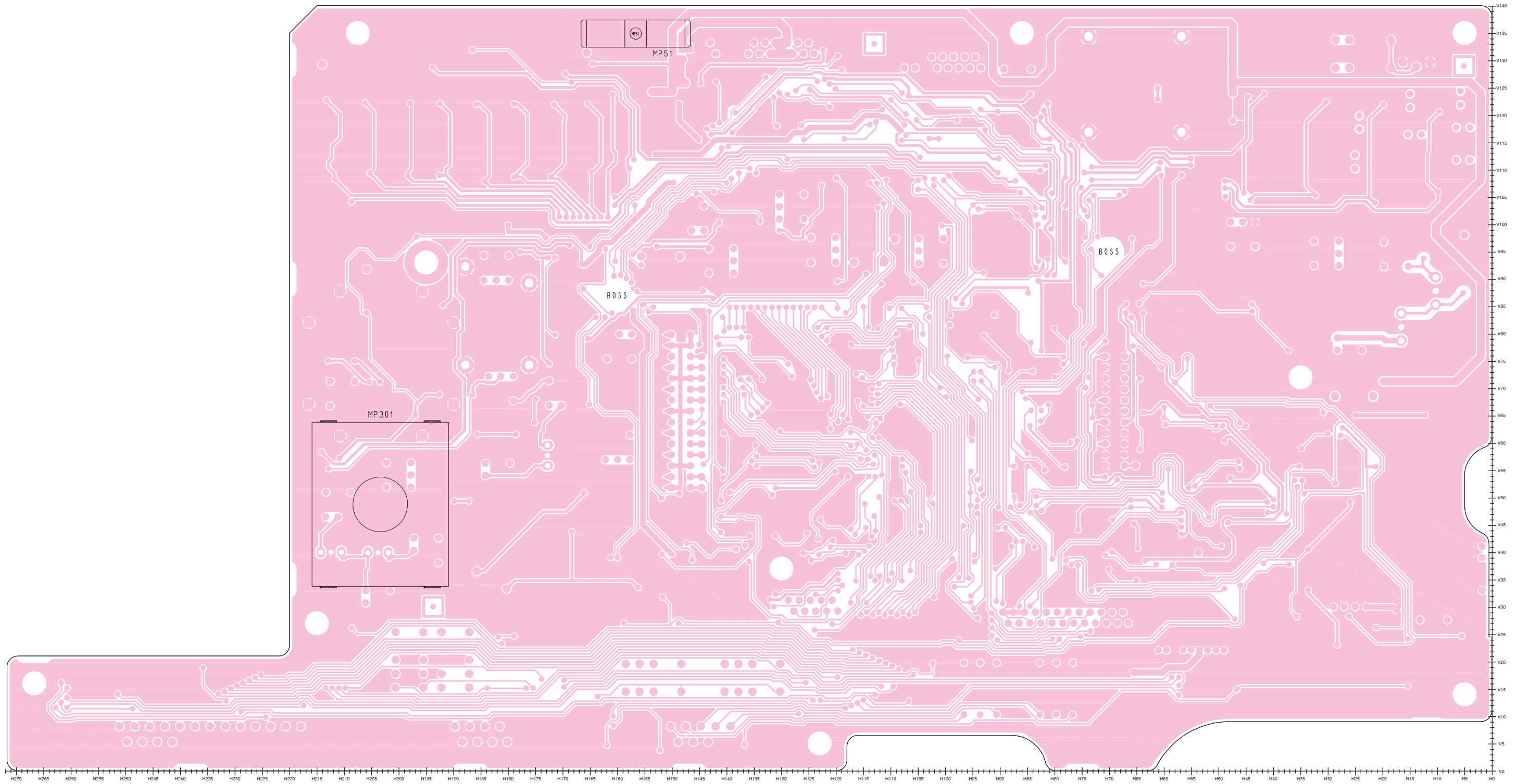

**8-2-3 FILTER UNIT**  
**• TOP VIEW**

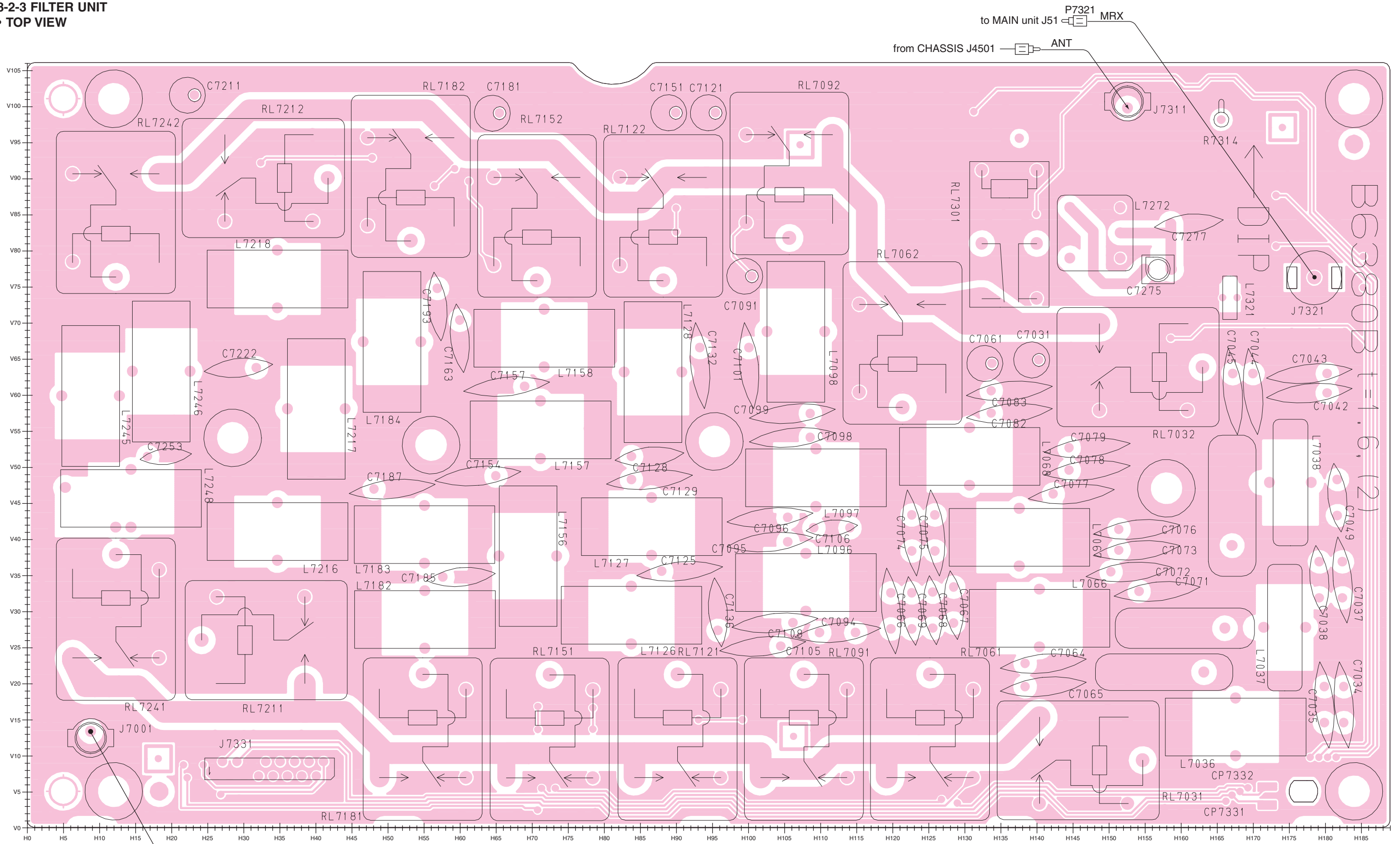

FLIN P7001 to PA unit J6401

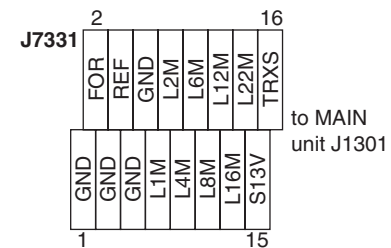

• BOTTOM VIEW (FILTER UNIT)

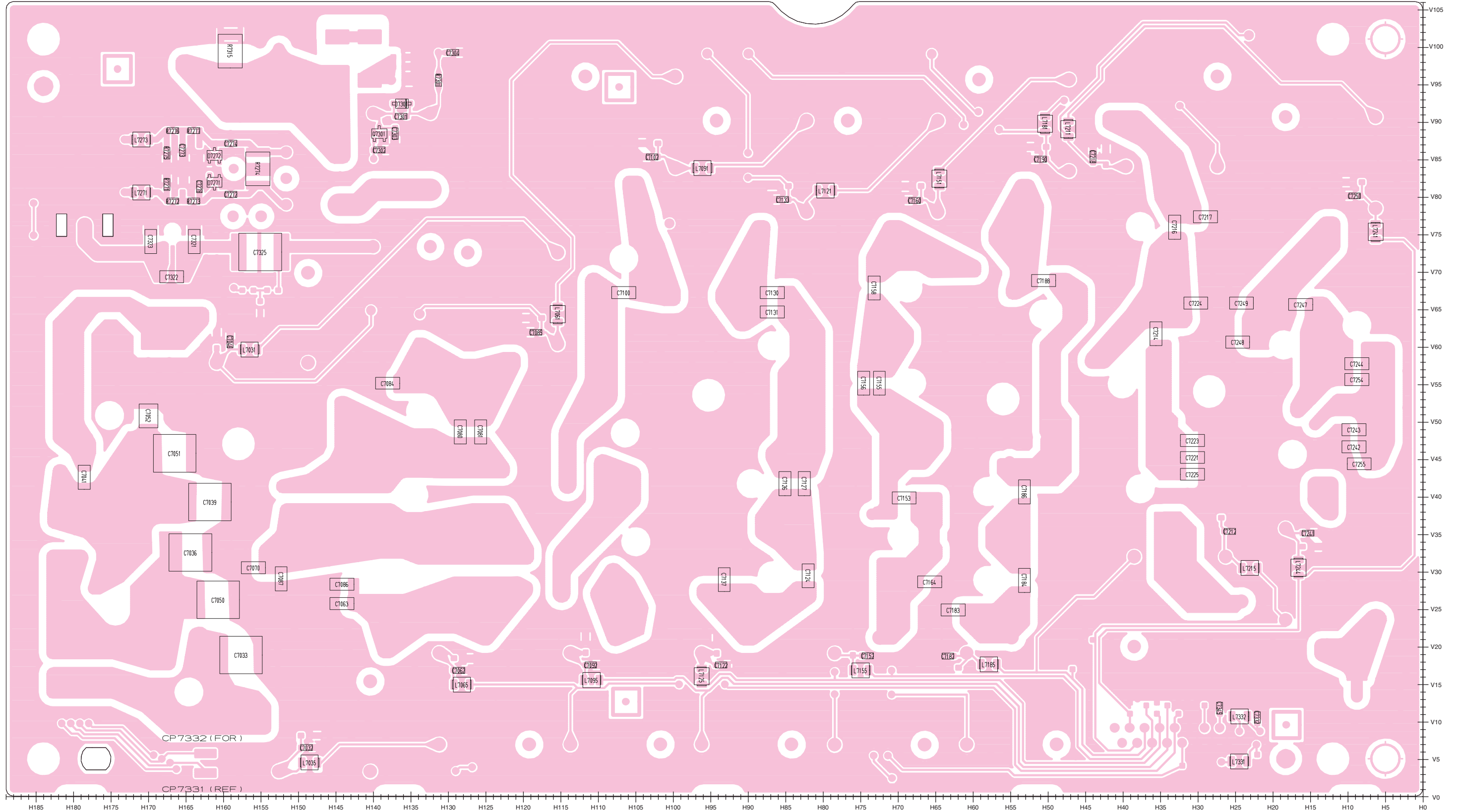



8-2-4 PLL UNIT

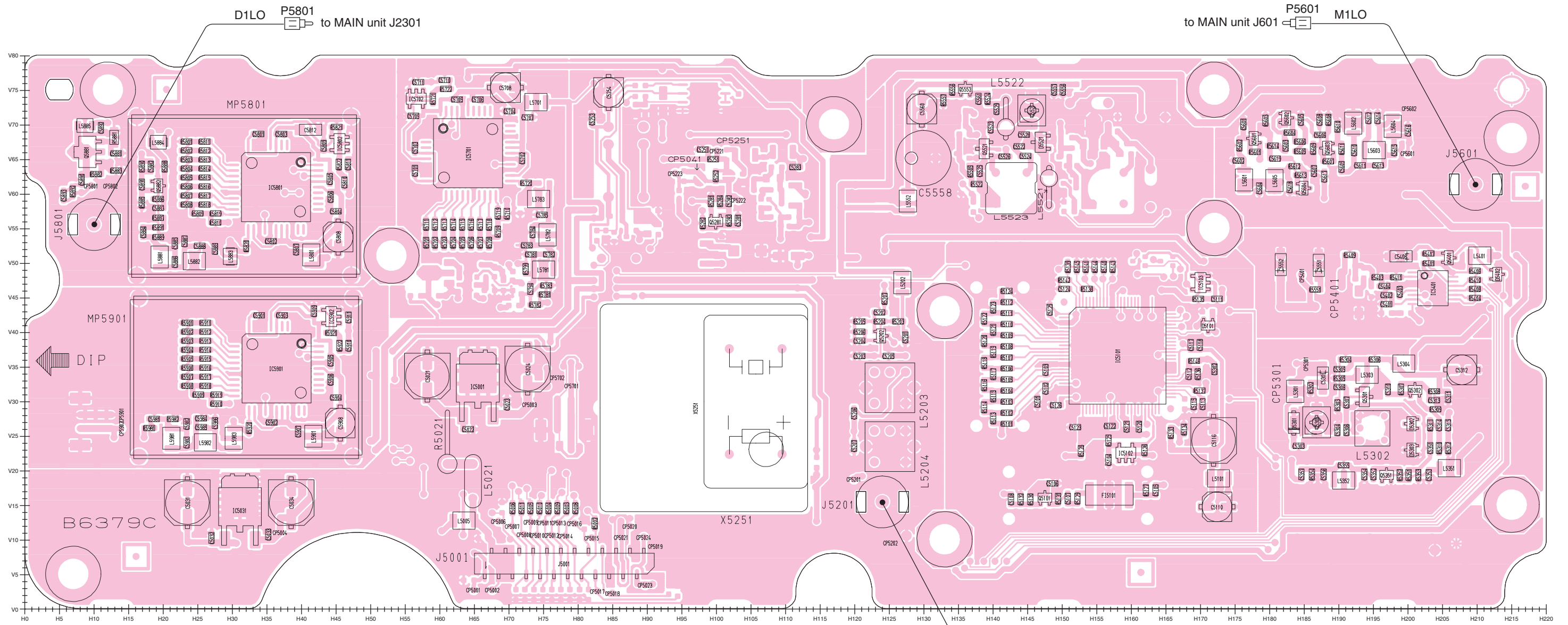

2		24	
J5001	S13V	H13V	1
	S13V	S13V	
	UNLK	PDAT	
	PCK	PST1	
	PST2	PST3	
	PCO2	PST4	
	REFV	DRES	
	REFV	REFS	
	PTMP	GND	
	GND	M3LO	
	GND	D2LO	
			23
		to MAIN unit J3601	

8-2-5 PA UNIT

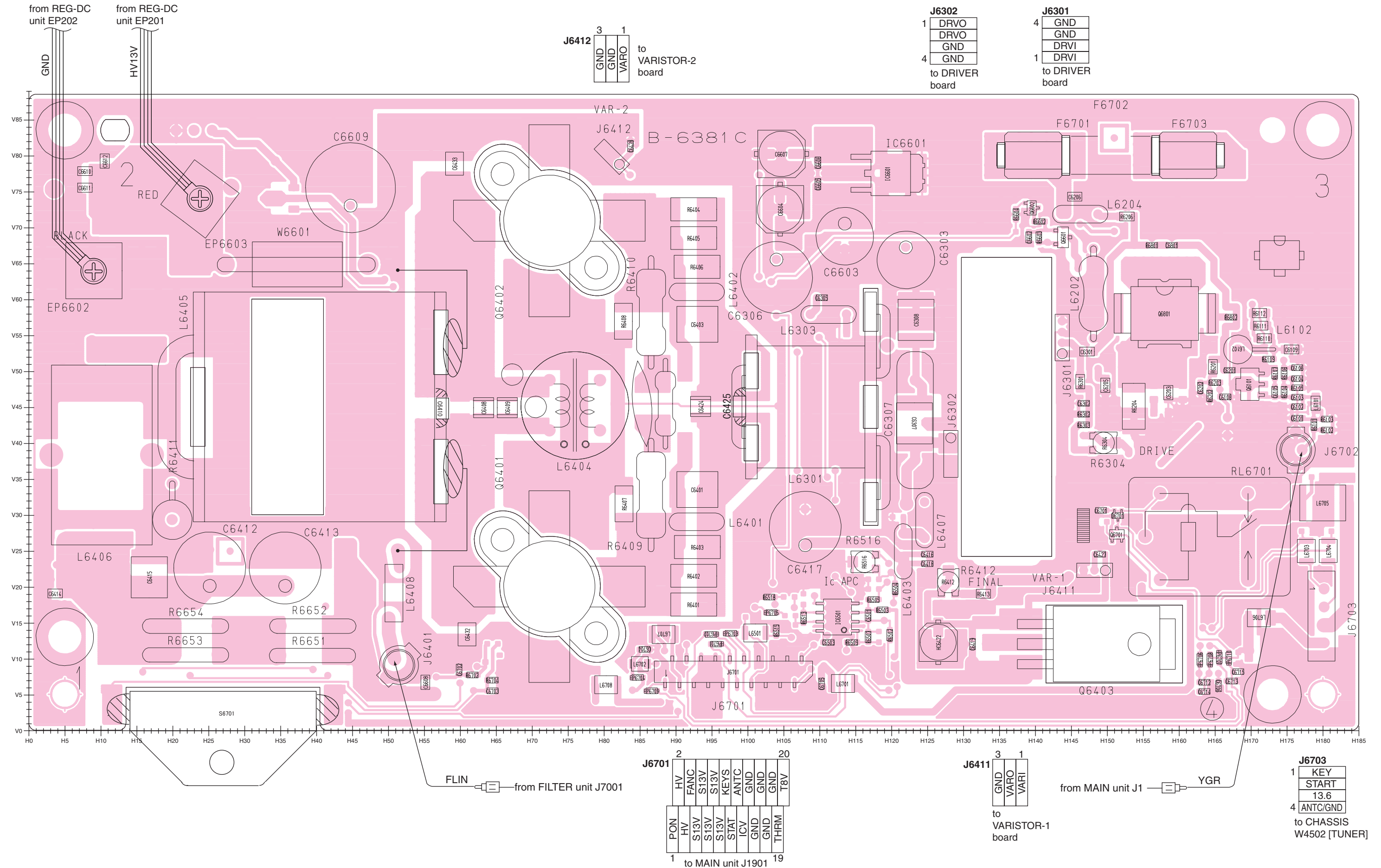

**8-2-6 REG-DC UNIT**  
• TOP VIEW

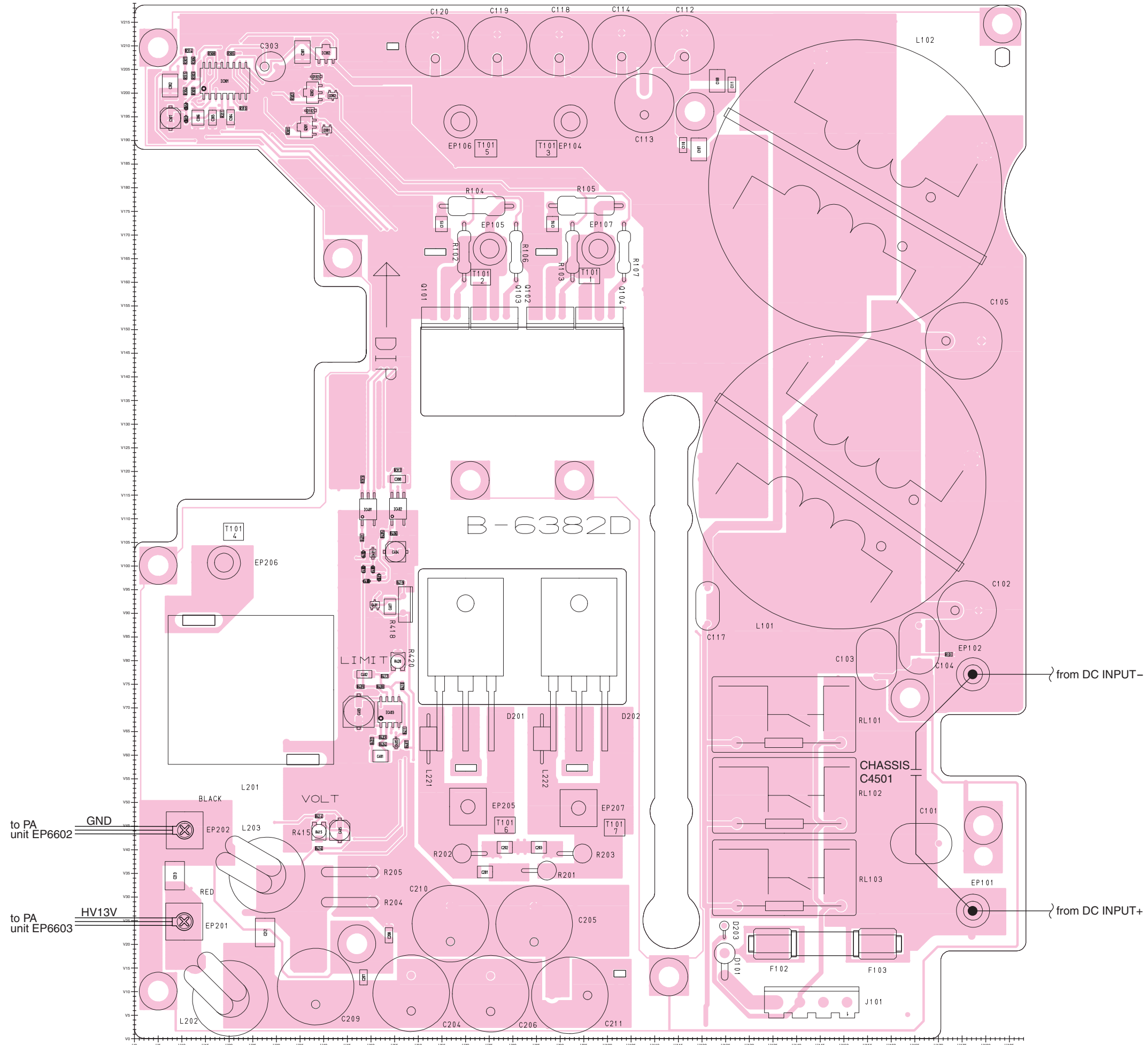

**8-2-7 DRIVER BOARD**  
• TOP VIEW

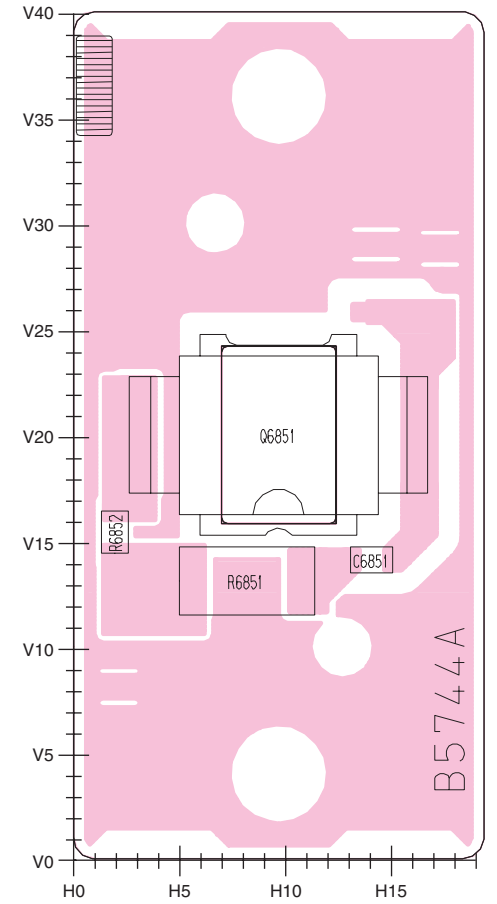

**8-2-8 VARISTAR-1 BOARD**

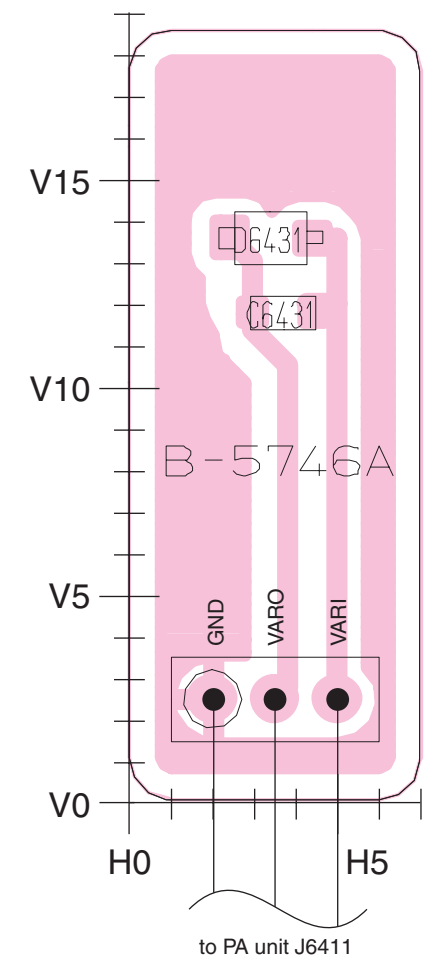

• BOTTOM VIEW (DRIVER BOARD)

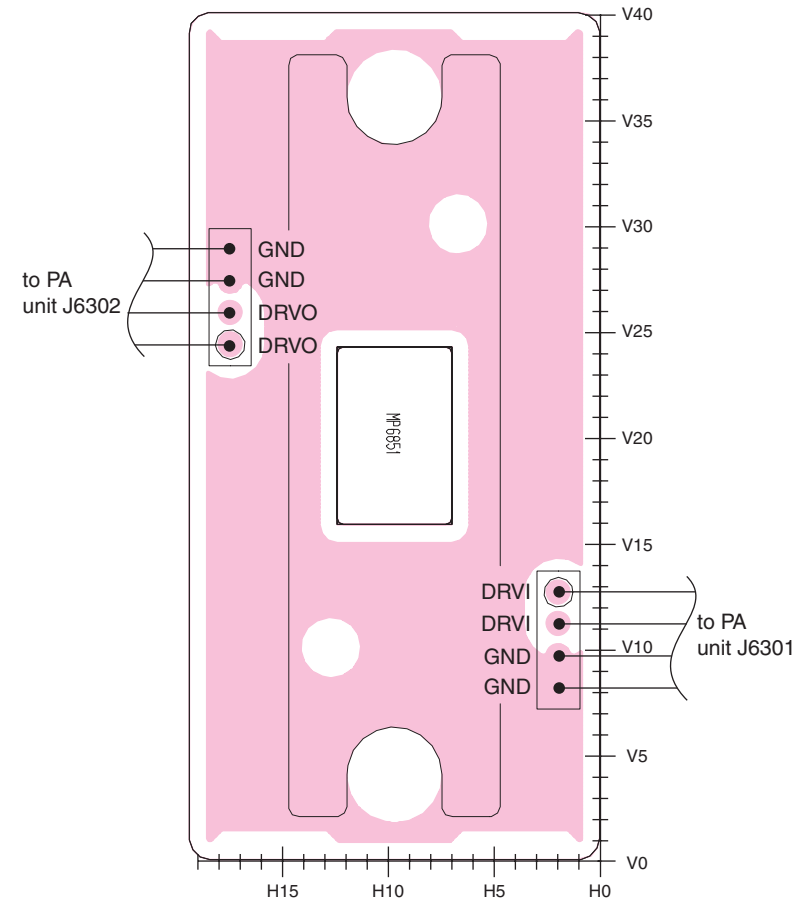

8-2-9 VARISTAR-2 BOARD

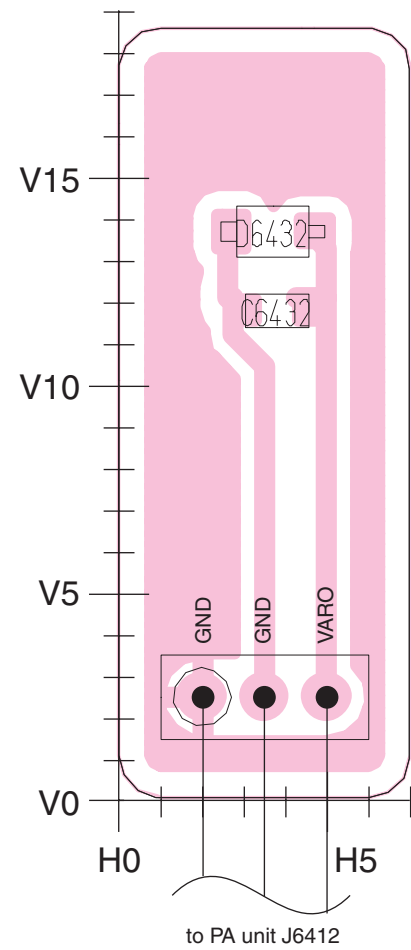

• BOTTOM VIEW (REG-DC UNIT)

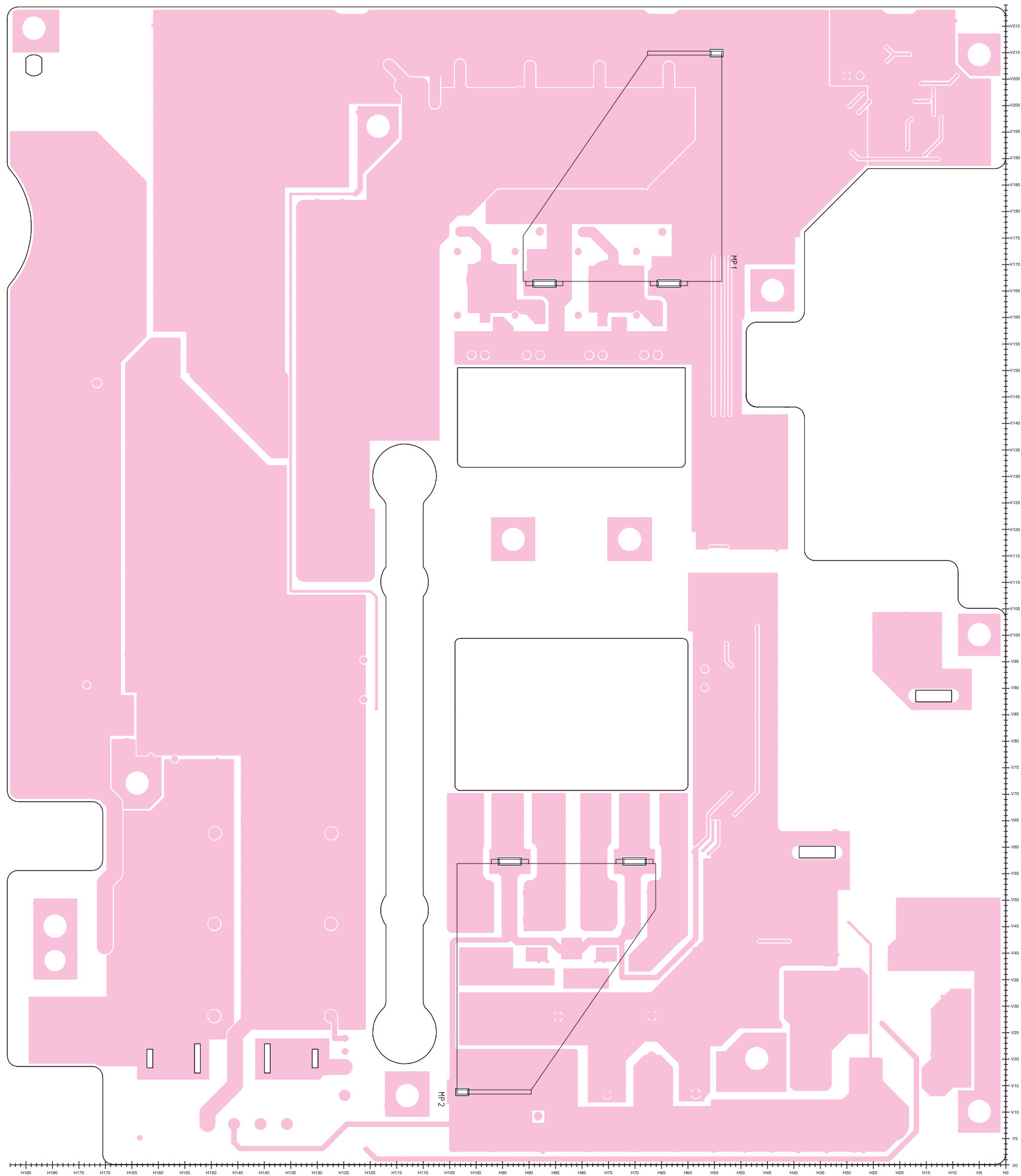

# SECTION 9 BLOCK DIAGRAM

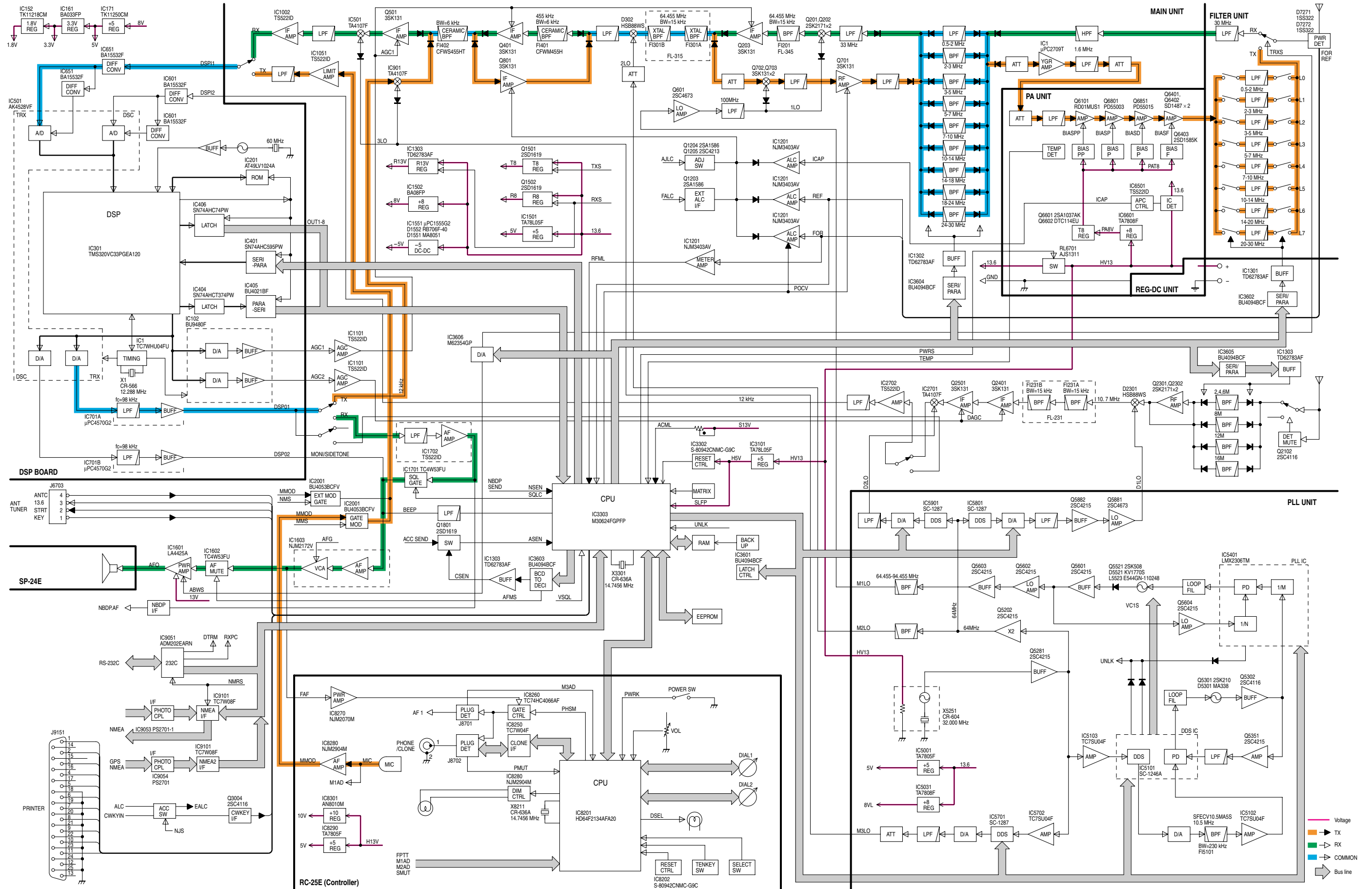

# SECTION 10 WIRING DIAGRAM

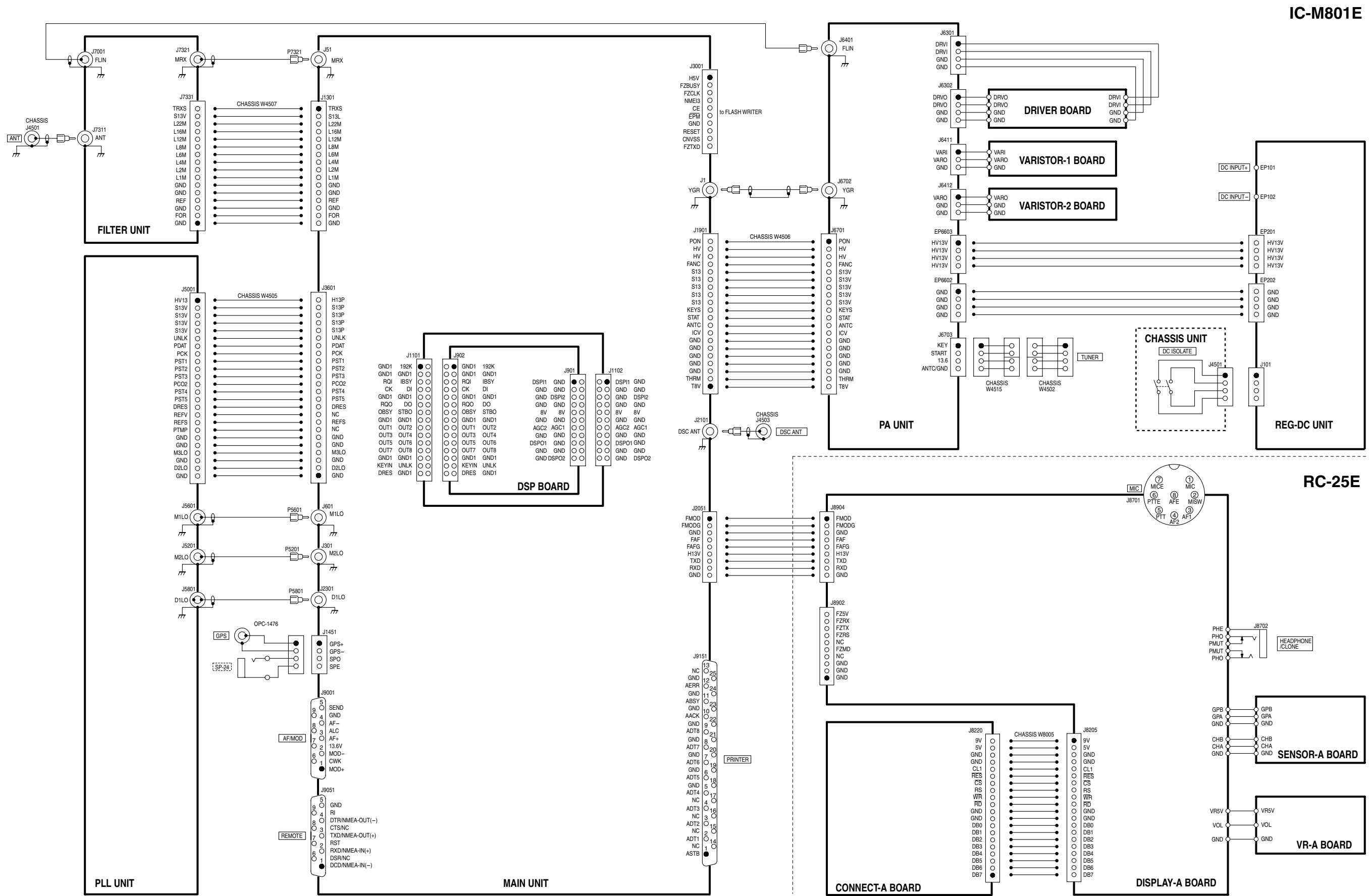

IC-M801E

RC-25E

# SECTION 11 VOLTAGE DIAGRAMS

## 11-1 RC-25E

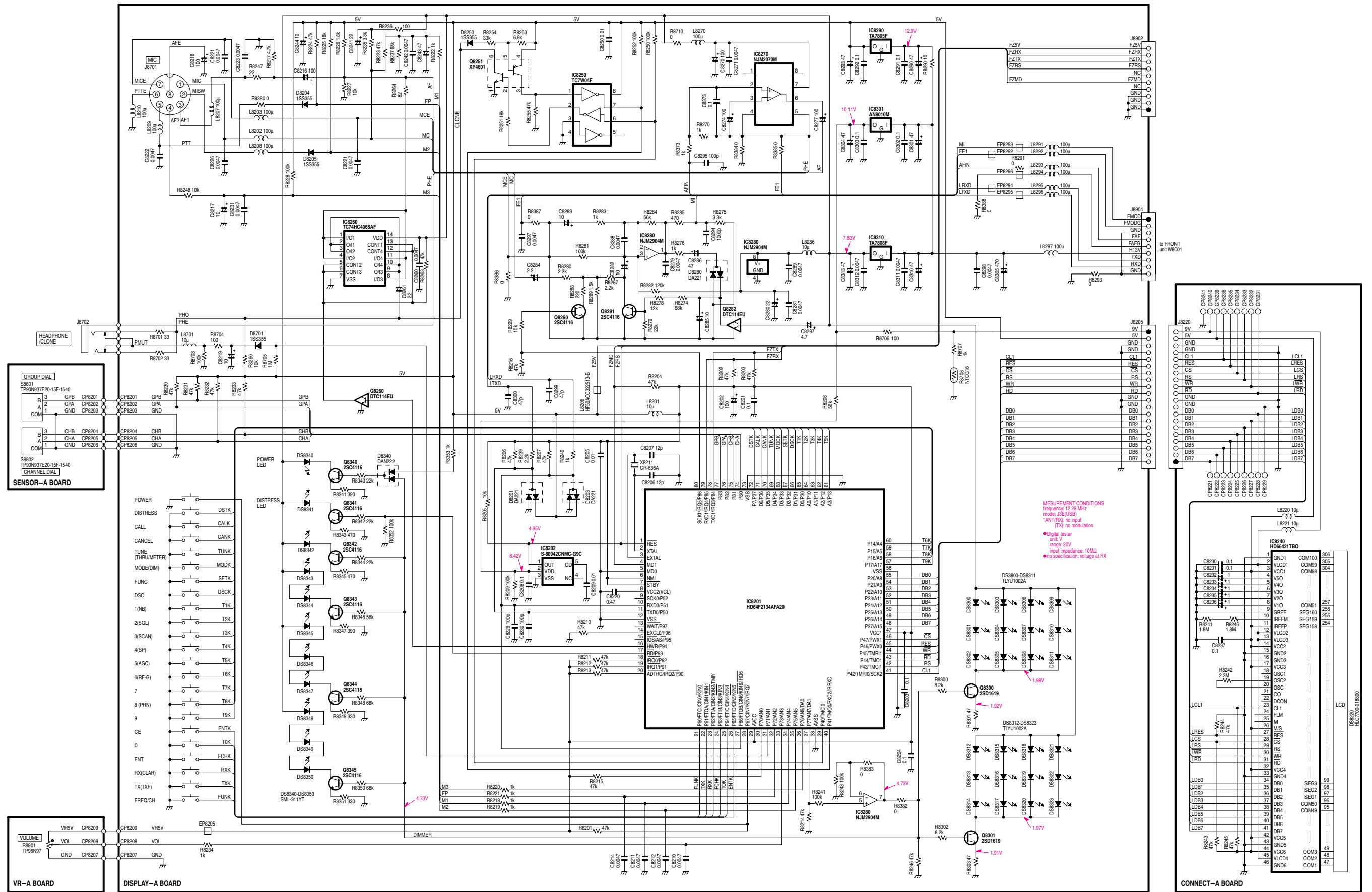

11-2 MAIN UNIT

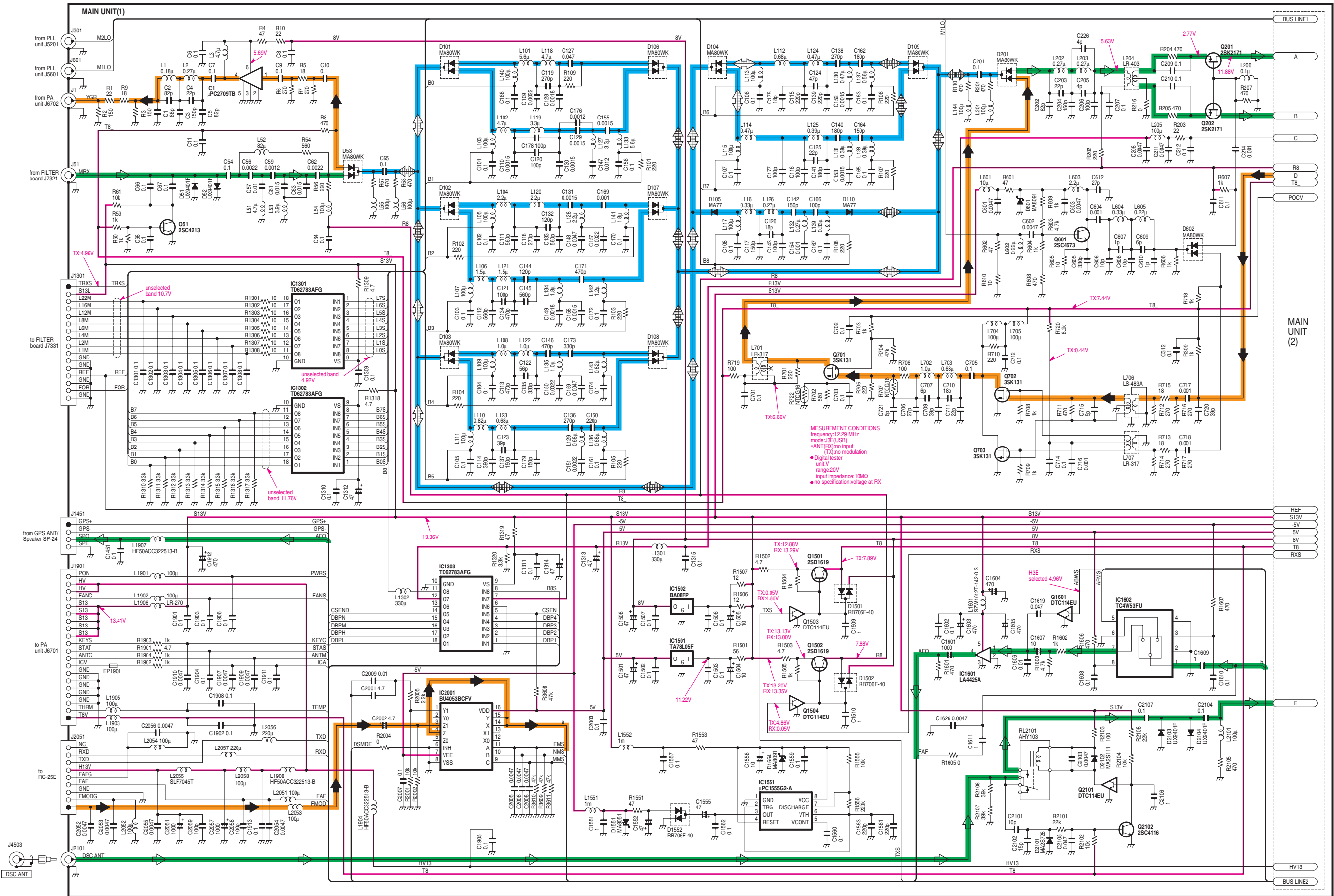



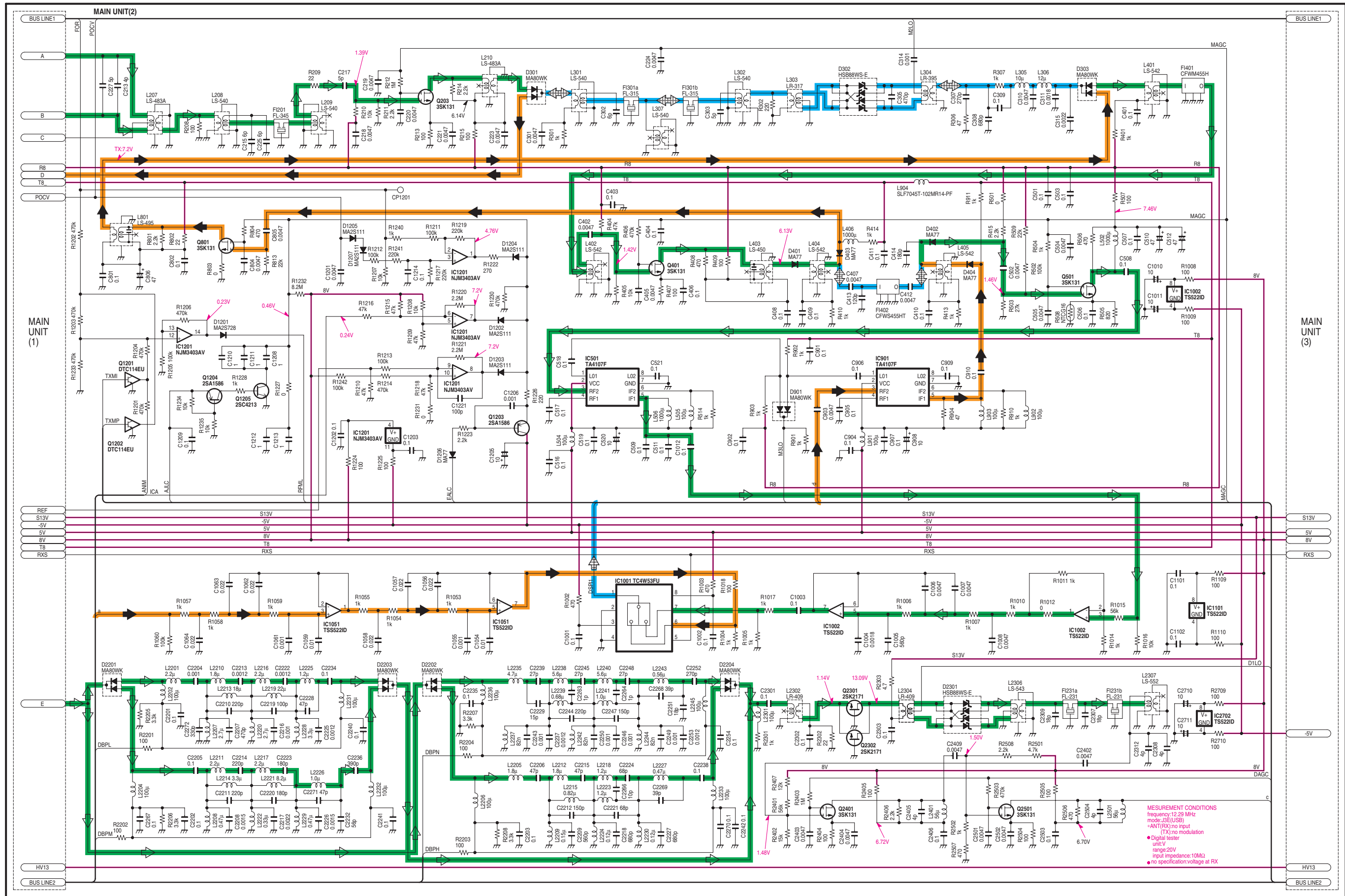

MEASUREMENT CONDITIONS  
 frequency: 12.29 MHz  
 mode: J3E(USB)  
 \*ANTI (RX) no input  
 TX: no modulation  
 • Digital tester  
 unit: V  
 range: 20V  
 input impedance: 10MΩ  
 • no specification voltage at RX

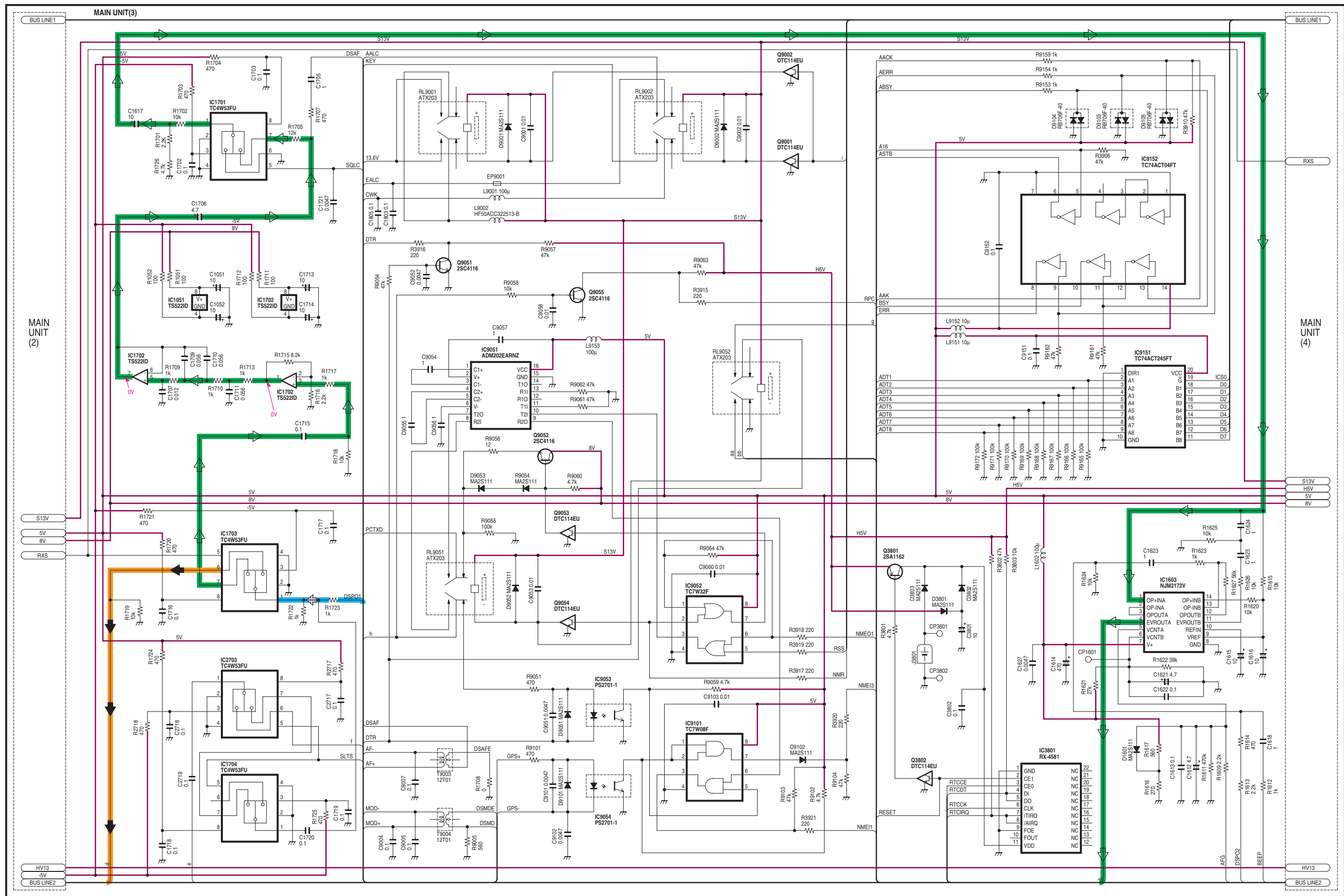

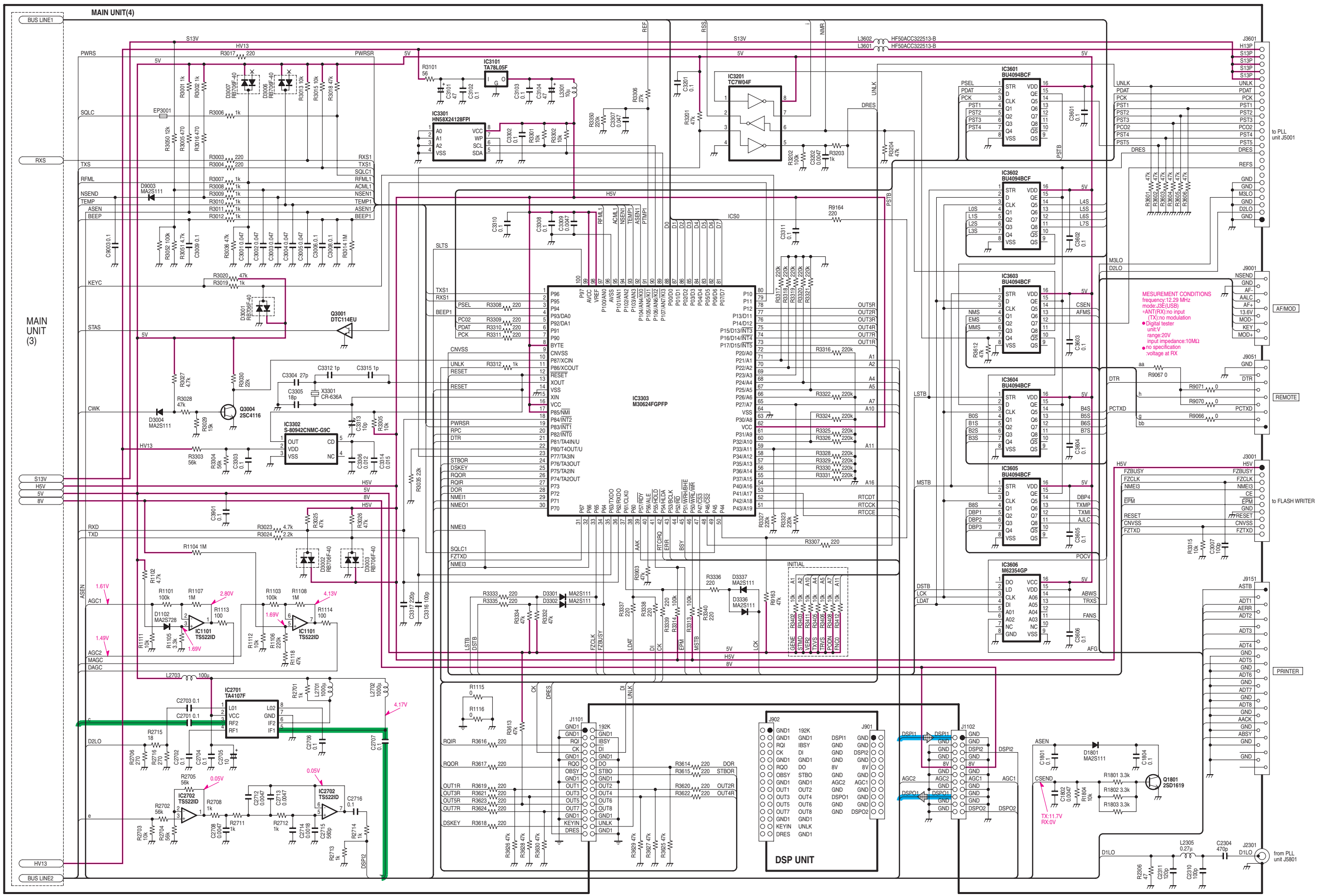

**MEASUREMENT CONDITIONS**  
 frequency: 12.29 MHz  
 mode: J3E (USB)  
 +ANTENNA input (TX): no modulation  
 • Digital tester unit V range: 20V input impedance: 10MΩ  
 • no specification voltage at RX

11-3 PA UNIT

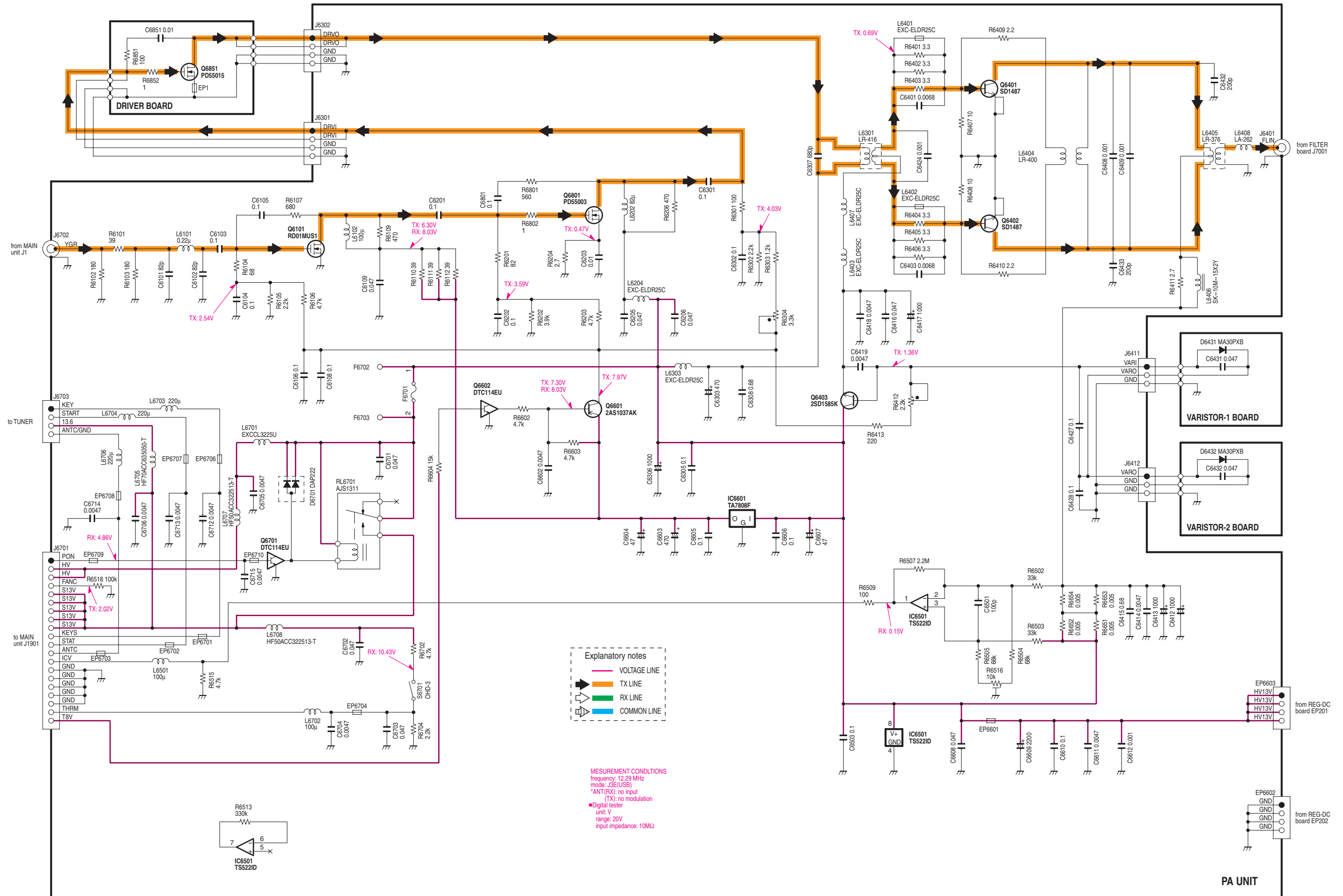

# 11-4 FILTER UNIT

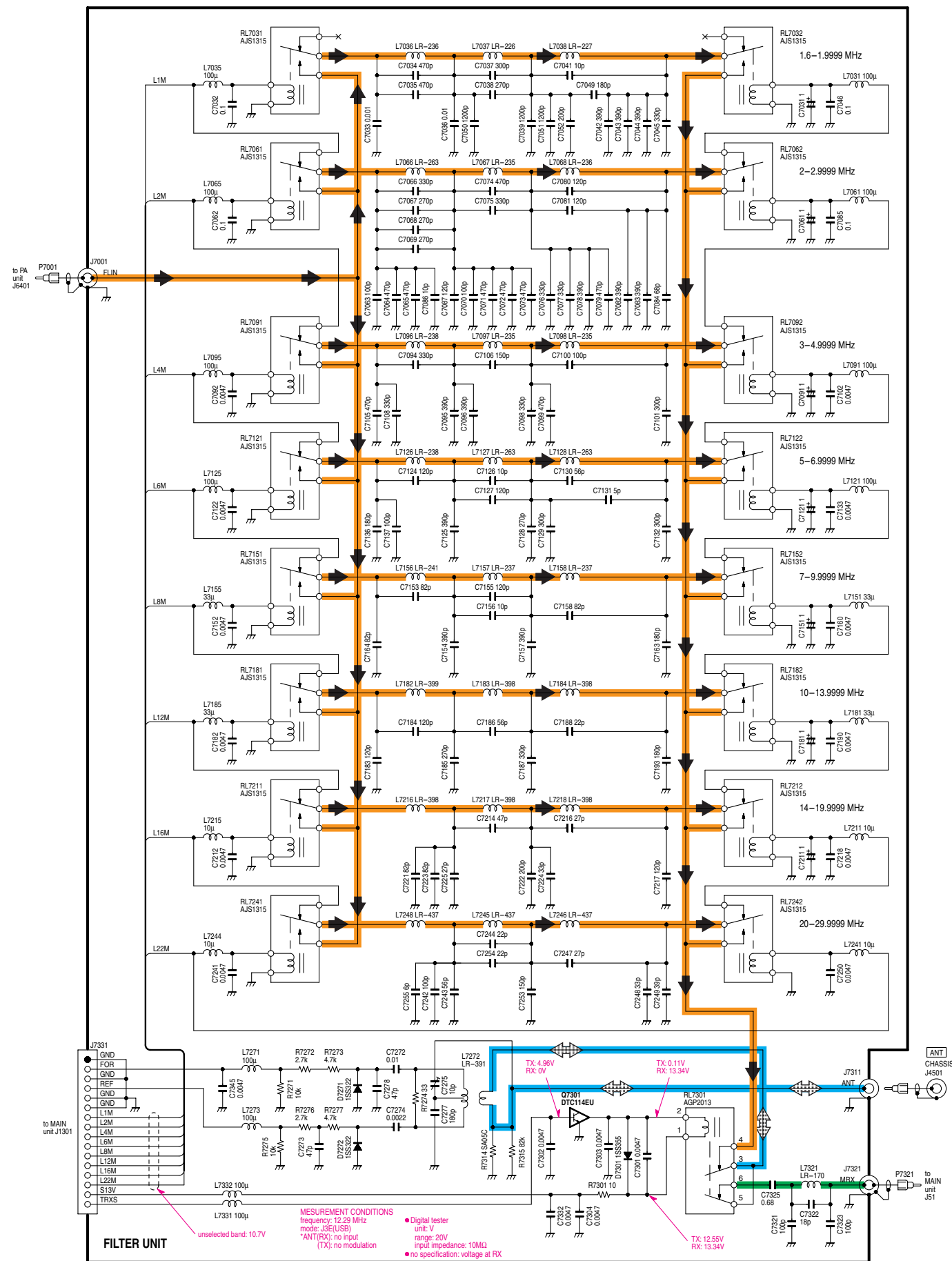

# 11-5 PLL UNIT

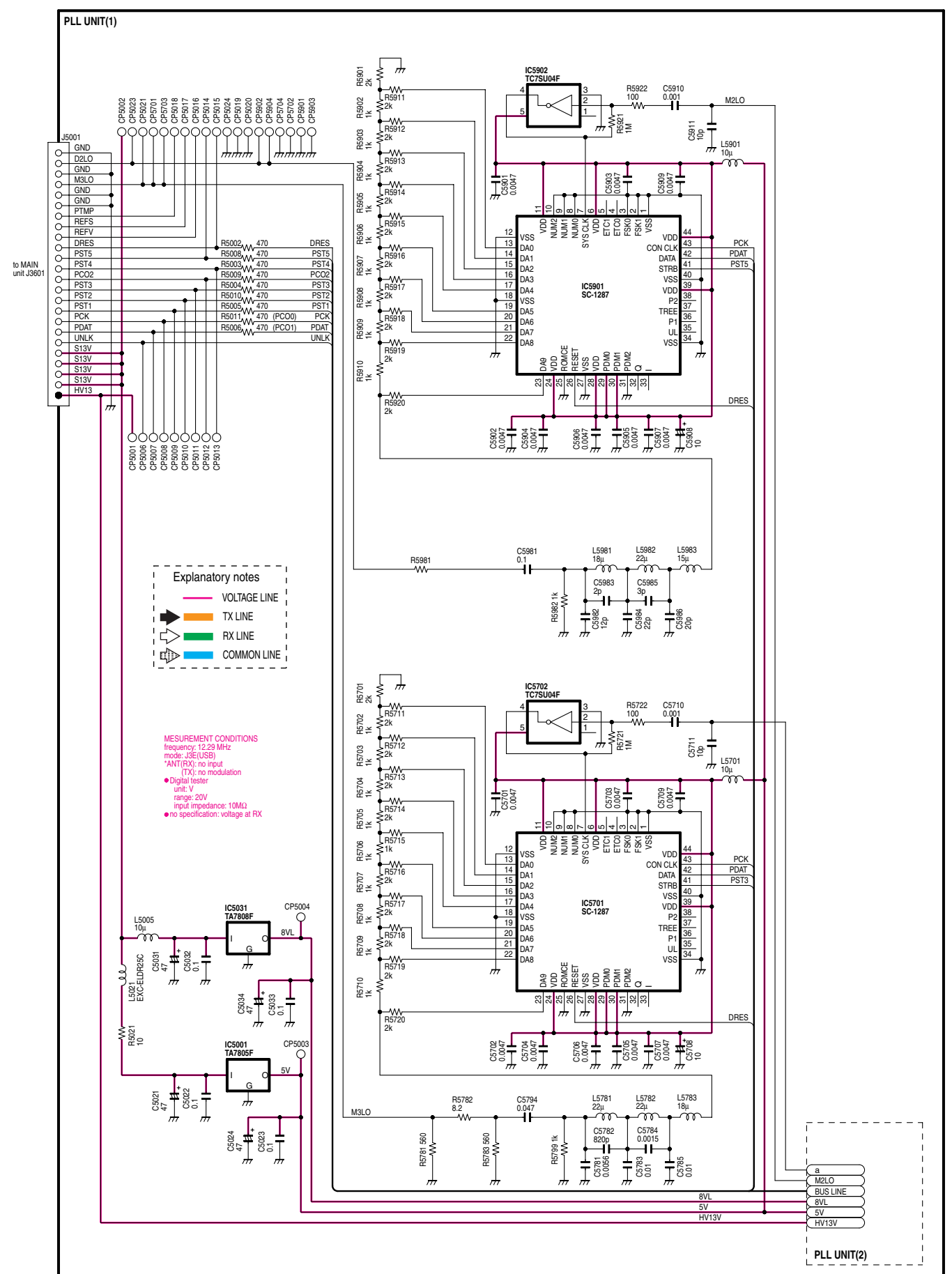

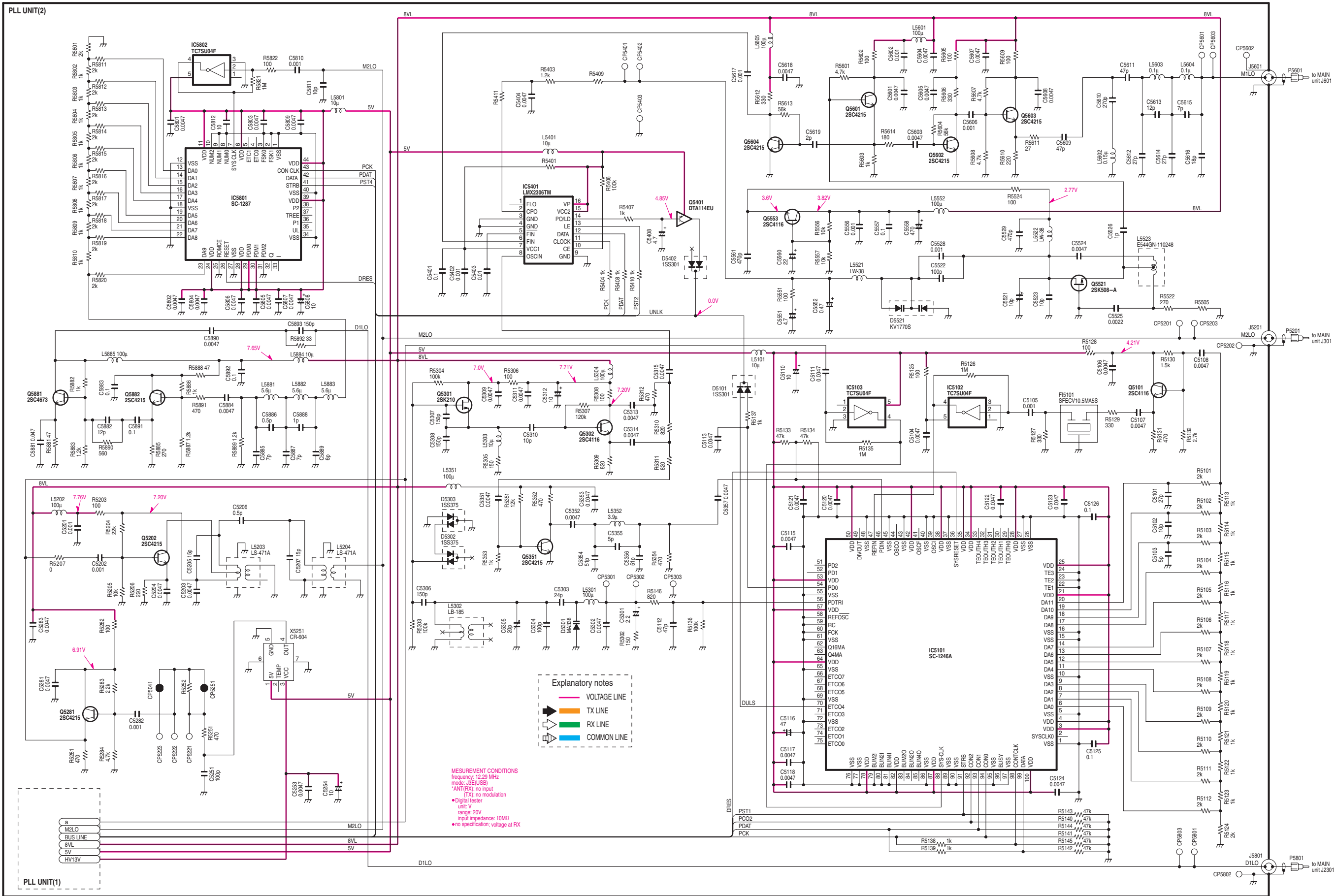

# 11-6 DSP BOARD

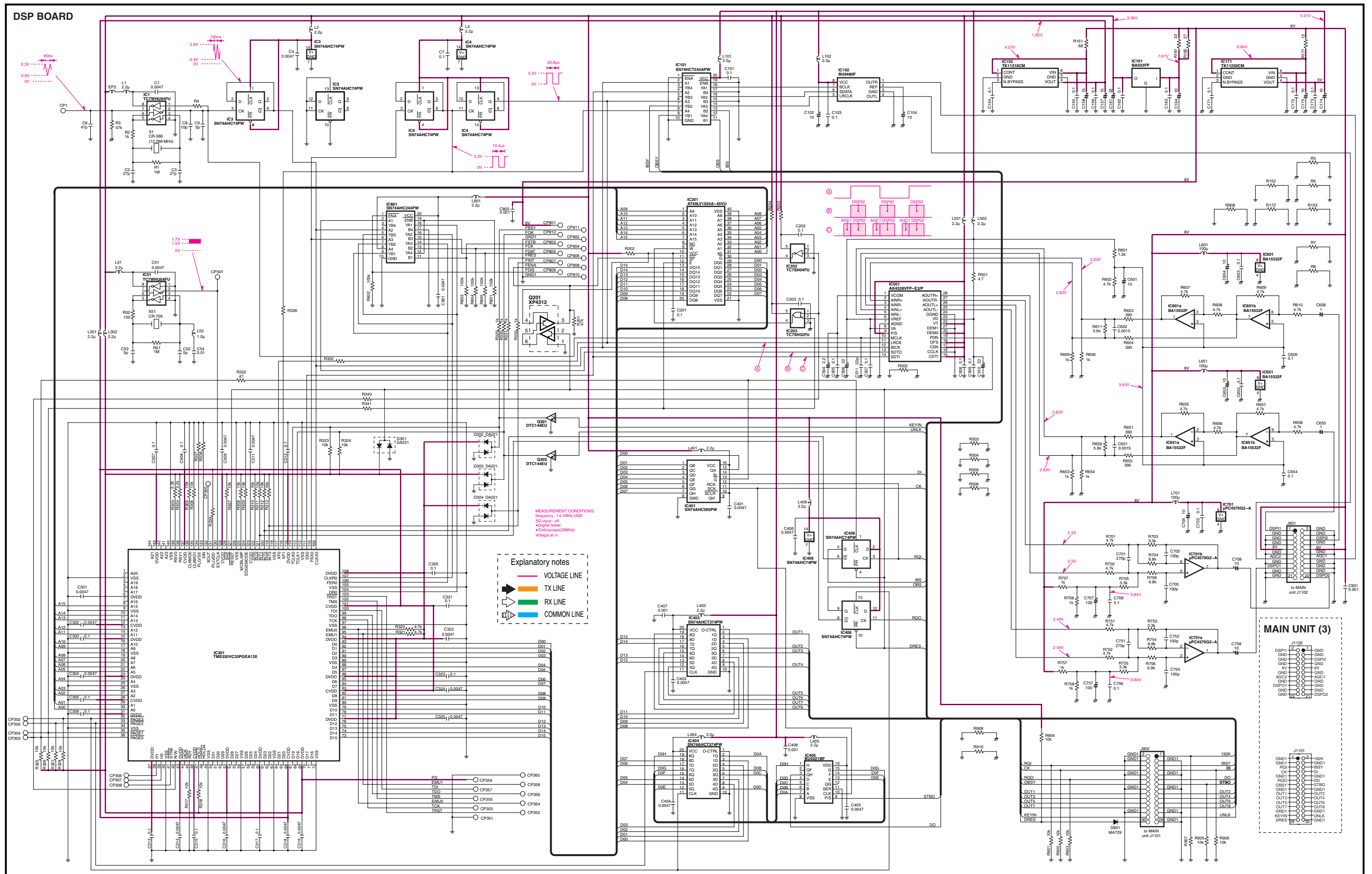

# 11-7 REG-DC UNIT

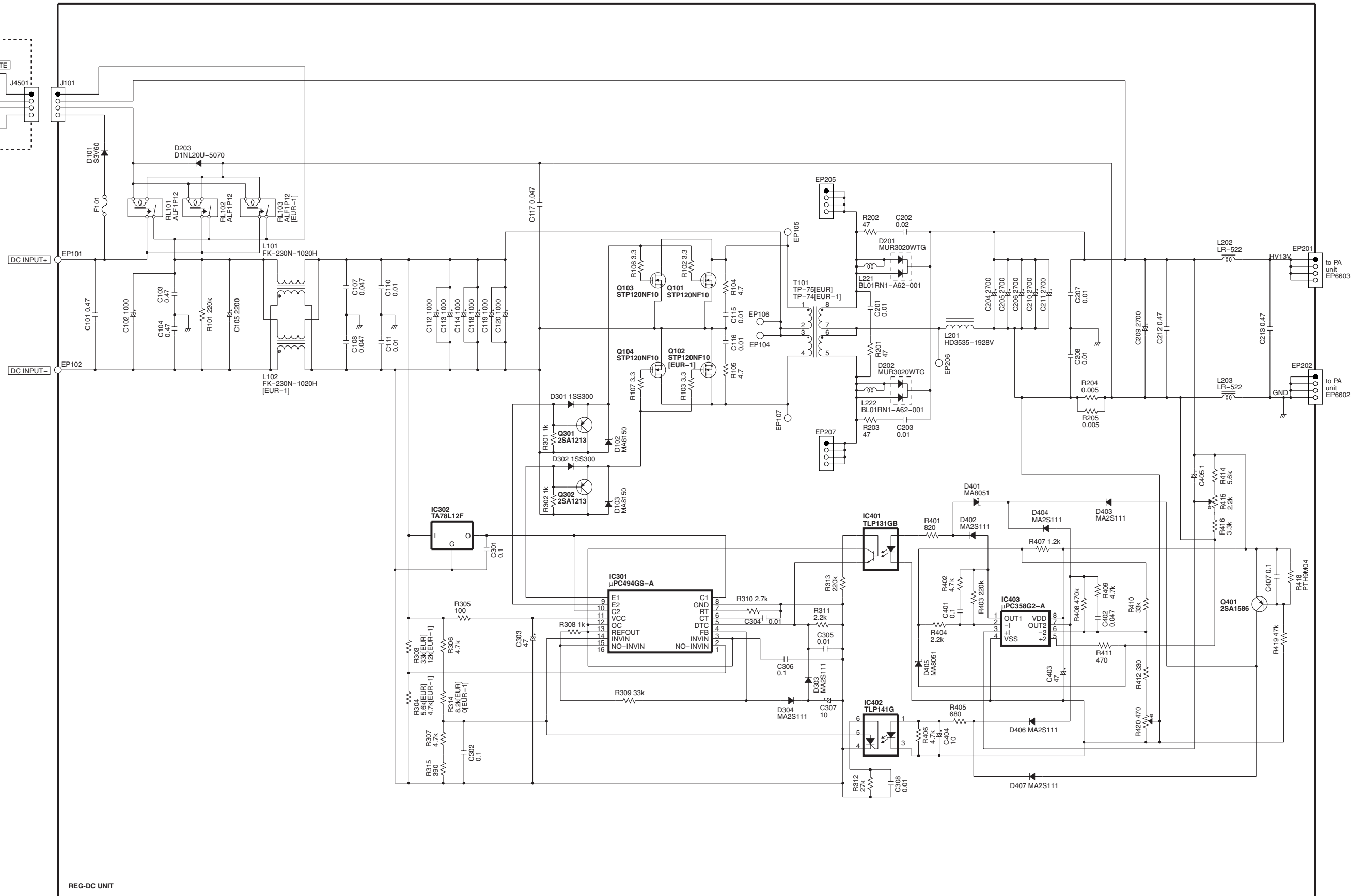
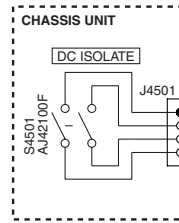



# SERVICE MANUAL

HF AUTOMATIC ANTENNA TUNER

# AT-141

---

**SECTION 1 SPECIFICATIONS**

**SECTION 2 INSIDE VIEWS**

**SECTION 3 CIRCUIT DESCRIPTION**

3-1	RECEIVER CIRCUITS .....	B-3-1
3-2	TRANSMITTER CIRCUITS .....	B-3-1
3-3	POWER SUPPLY CIRCUITS .....	B-3-1
3-4	OTHER CIRCUITS .....	B-3-2

**SECTION 4 ADJUSTMENT PROCEDURES**

**SECTION 5 PARTS LIST**

**SECTION 6 MECHANICAL PARTS AND DISASSEMBLY**

**SECTION 7 SEMI-CONDUCTOR INFORMATION**

**SECTION 8 BOARD LAYOUT**

**SECTION 9 BLOCK DIAGRAM**

**SECTION 10 VOLTAGE DIAGRAM**

# SECTION 1 SPECIFICATIONS

## ■ GENERAL

- Number of memory channels : 45
- Frequency coverage : 1.6–30 MHz with a 7 m or longer antenna element
- Maximum input power : 150 W PEP  
100 W continuous
- Input impedance : 50  $\Omega$
- Minimum operating input power : 5–15 W
- Automatic tuning time : Approx. 2 to 3 sec. (max. 15 sec.)
- Tuning accuracy (VSWR) : Better than 2.0 : 1  
(after tuning; except for multiples of  $1/2 \lambda$ )
- Power supply requirement : 13.6 V DC  $\pm$  15% (supplied from the transceiver)
- Driving current : Less than 2 A
- Usable temperature range :  $-30^{\circ}\text{C}$  to  $+60^{\circ}\text{C}$
- Dimensions (projections not included) : 230(W)  $\times$  80(H)  $\times$  340(D) mm
- Case construction : Weatherproof
- Weight : Approx. 2.5 kg

**All stated specifications are subject to change without notice or obligation.**

## SECTION 2 INSIDE VIEWS

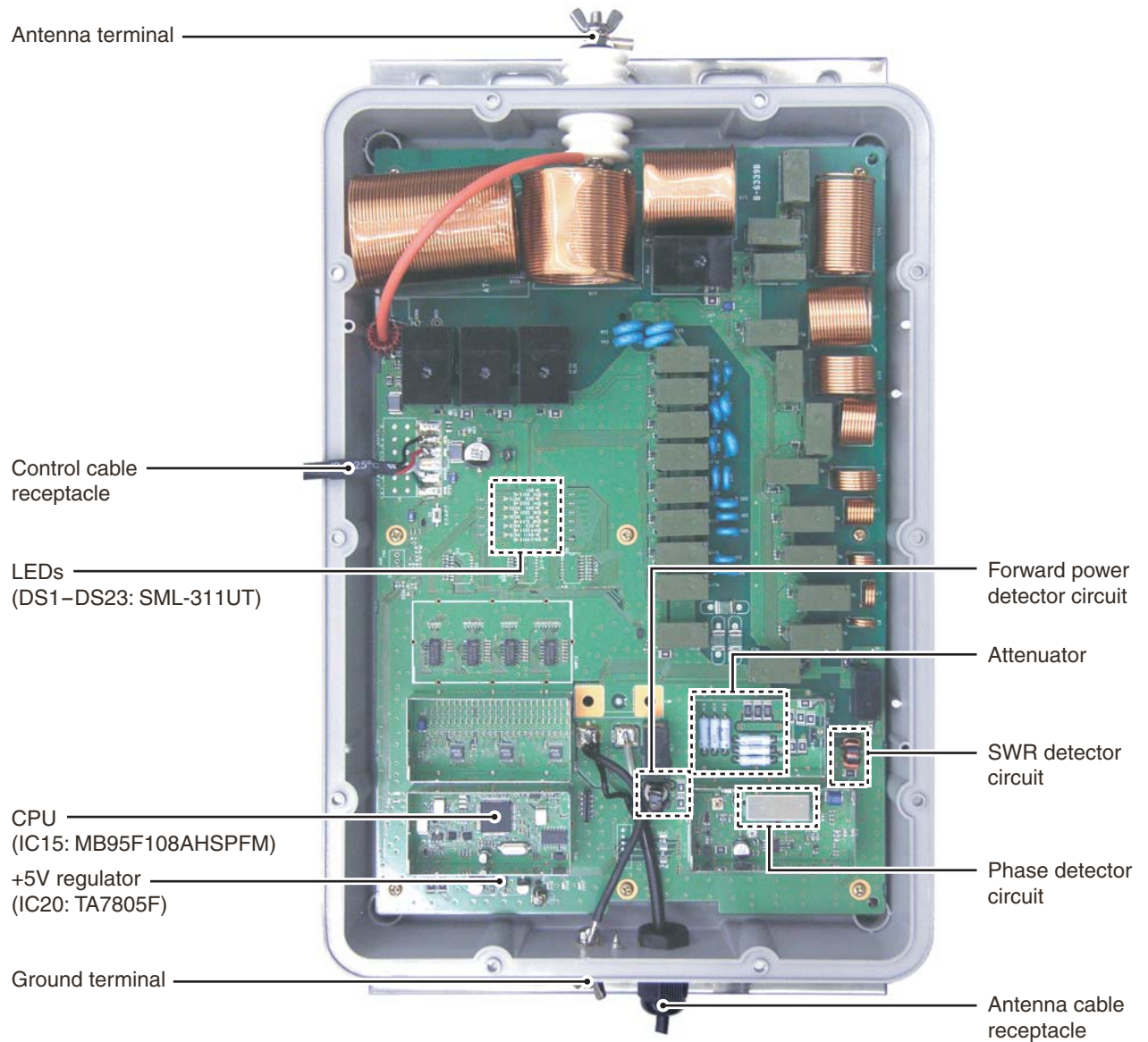

# SECTION 3 CIRCUIT DESCRIPTION

## 3-1 GENERAL

An 8-bit microprocessor controls the AT-141. The antenna tuner matches the antenna system to the transceiver by using four kinds of detector circuits.

- (1) FORWARD POWER DETECTOR
- (2) SWR DETECTOR
- (3) PHASE DETECTOR
- (4) IMPEDANCE DETECTOR

Detailed descriptions for each circuit as follows.

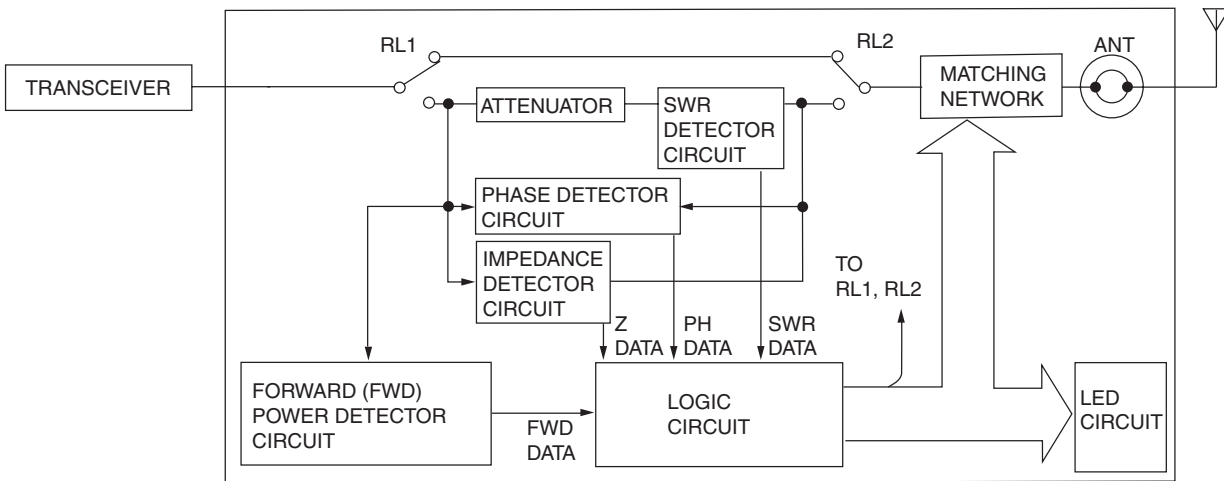

## 3-2 FORWARD (FWD) POWER DETECTOR CIRCUIT

This circuit ensures the input power from the transceiver is low enough to be handled by the attenuator within the tuner.

The RF power from the connected transceiver is detected at the power detector (L1) and then converted into a DC voltage. The converted voltage is applied to the CPU (IC15, pin 62) and then analyzed input RF power.

### • FORWARD POWER DETECTOR CIRCUIT

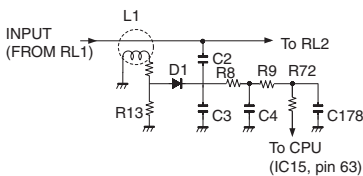

## 3-3 SWR DETECTOR CIRCUIT

The SWR detector detects the reflected signal from the antenna system.

The reflected signal is detected at the SWR detector (L4) and then converted into DC voltage at D13, D14. The converted voltage is applied to the CPU (IC15, pin 62) and the CPU controls the setting of the coils and capacitors in the matching network.

### • SWR DETECTOR CIRCUIT

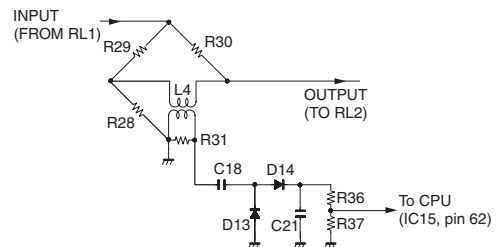

### 3-4 PHASE DETECTOR CIRCUIT

The phase detector consists of L2, L3 and D81. The phase detector's purpose is to detect reactance components and provide a pure resistance.

The output of D81 is a reference voltage of approximately 0 V when the load of L3 is a pure resistance with no reactance. An inductive load produces an output voltage from D81 which is lower than the reference voltage, whereas, a capacitive load produces an output voltage higher than the reference voltage. The output voltage from the phase detector is applied to the comparator (IC19b) and then applied to the CPU (IC15, pin 23).

#### • PHASE DETECTOR CIRCUIT

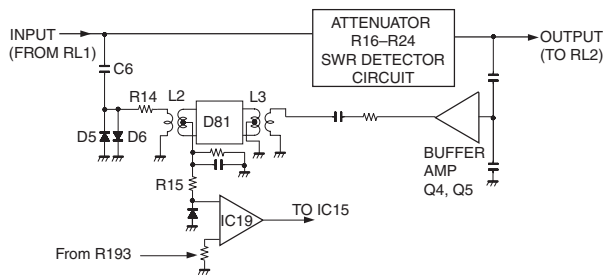

### 3-5 IMPEDANCE DETECTOR CIRCUIT

The tuner uses an attenuator to reduce the transmit power to a very low level. The low power minimizes the risk of interference to other stations while matching an antenna to the transmitter.

The VSWR at the input terminal is usually close to 1:1 even with a large change of impedance at the attenuator output due to the 16 dB of isolation between the input and the matching network.

The circuit uses the constant voltage at D7 and D8 as a reference. If the impedance of the attenuator output is higher than 50 Ω, the detected voltage by D11 and D12 is high. If the impedance is lower than 50 Ω, the voltage is low. Both the reference and detected voltages are applied to the comparator (IC19a). The output voltage from the comparator is applied to the CPU (IC15, pin 24)

#### • IMPEDANCE DETECTOR CIRCUIT

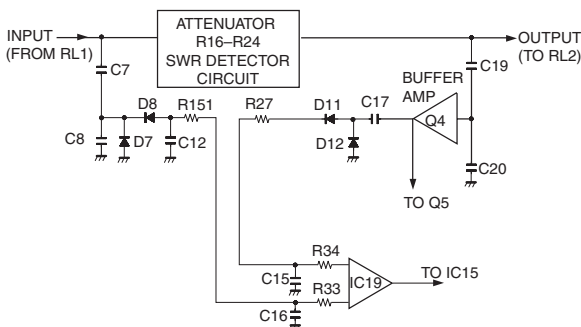

### 3-6 LOGIC CIRCUIT

The CPU (IC15) controls the antenna matching network. The CPU receives +5V through IC20 when DC power is applied to the tuner. This voltage initializes the CPU and then the CPU sets each relay to the initial condition.

The tuning program begins only if the START line is at LOW level. RL1 and RL2 activate when RF power is applied to the tuner from the transceiver.

### 3-8 ANTENNA CURRENT DETECTOR CIRCUIT

Antenna current detected at antenna current detector (L35). The detected voltage is converted into a DC voltage at D86 and then applied to the ANTC line after passed through the low-pass filter (L36, C286).

#### • ANTENNA CURRENT DETECTOR CIRCUIT

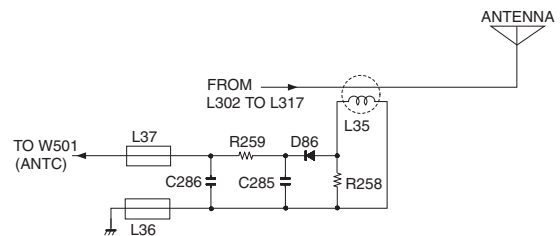

# SECTION 4 ADJUSTMENT PROCEDURES

## 4-1 PREPARATION

### ■ REQUIRED TEST EQUIPMENT

EQUIPMENT	GRADE AND RANGE
DC power supply	Output voltage : Depended on connected transceiver Current capacity : Depended on connected transceiver
Oscilloscope	Frequency range : DC-20 MHz Measuring range : 0.01-10 V

### • CONNECTION

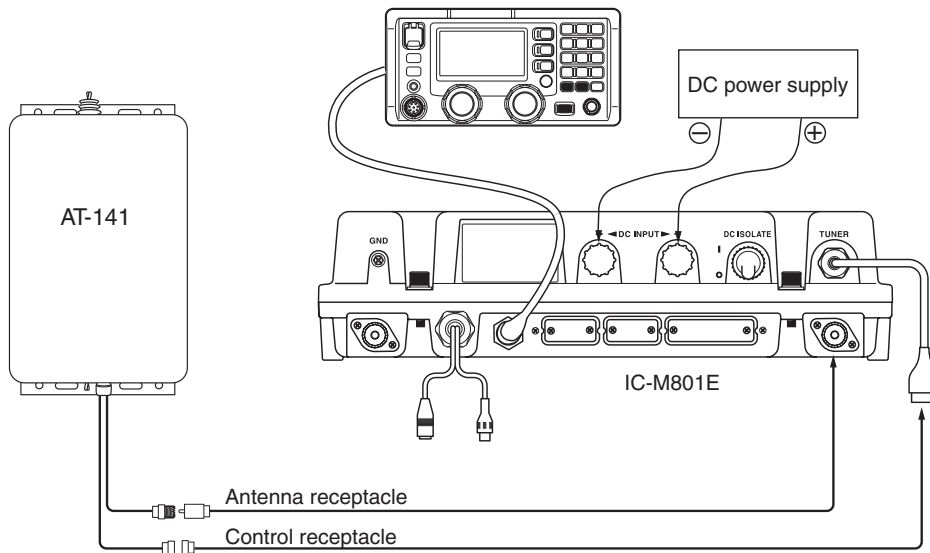

## 4-2 TUNER ADJUSTMENT

ADJUSTMENT	ADJUSTMENT CONDITION	MEASUREMENT		VALUE	ADJUSTMENT	
		UNIT	LOCATION		UNIT	ADJUST
PREPARATION	1 <ul style="list-style-type: none"> <li>• Disconnect short pin (P6) from J6</li> <li>• Connect the disconnected short pin (P6) to J13.</li> <li>• Connect a wire between CP15 and ground.</li> <li>• TRANSCEIVER Display frequency : 1.6000 MHz Output power : 10 W (Carrier only)</li> </ul>					
FORWARD DETECTOR CIRCUIT	2 <ul style="list-style-type: none"> <li>• Transmit the transceiver.</li> </ul>	TUNER	Connect a voltmeter to CP81.	1.4 – 2.4 V	TUNER	Verify
SWR DETECTOR CIRCUIT	3 <ul style="list-style-type: none"> <li>• Transmit the transceiver.</li> </ul>		Connect a voltmeter to CP84.	0 – 0.1 V		Verify
PHASE DETECTOR CIRCUIT	4 <ul style="list-style-type: none"> <li>• Transmit the transceiver.</li> </ul>		Connect an oscilloscope to CP81.	5 V (Set R194 at the point where the voltage just before drops to 0 V.)		R194
IMPEDANCE DETECTOR CIRCUIT	5 <ul style="list-style-type: none"> <li>• Transmit the transceiver.</li> </ul>		Connect an oscilloscope to CP83.	5 V (Set C7 at the point where the voltage just before drops to 0 V.)		C7

**NOTE:**

- After the adjustment, remove the jumper wire between CP15 and ground.
- After the adjustment, disconnect short pin (P6) from J13.
- After the adjustment, connect the disconnected short pin (P6) to J6.
- While the adjustment the transmitting time as short as possible.

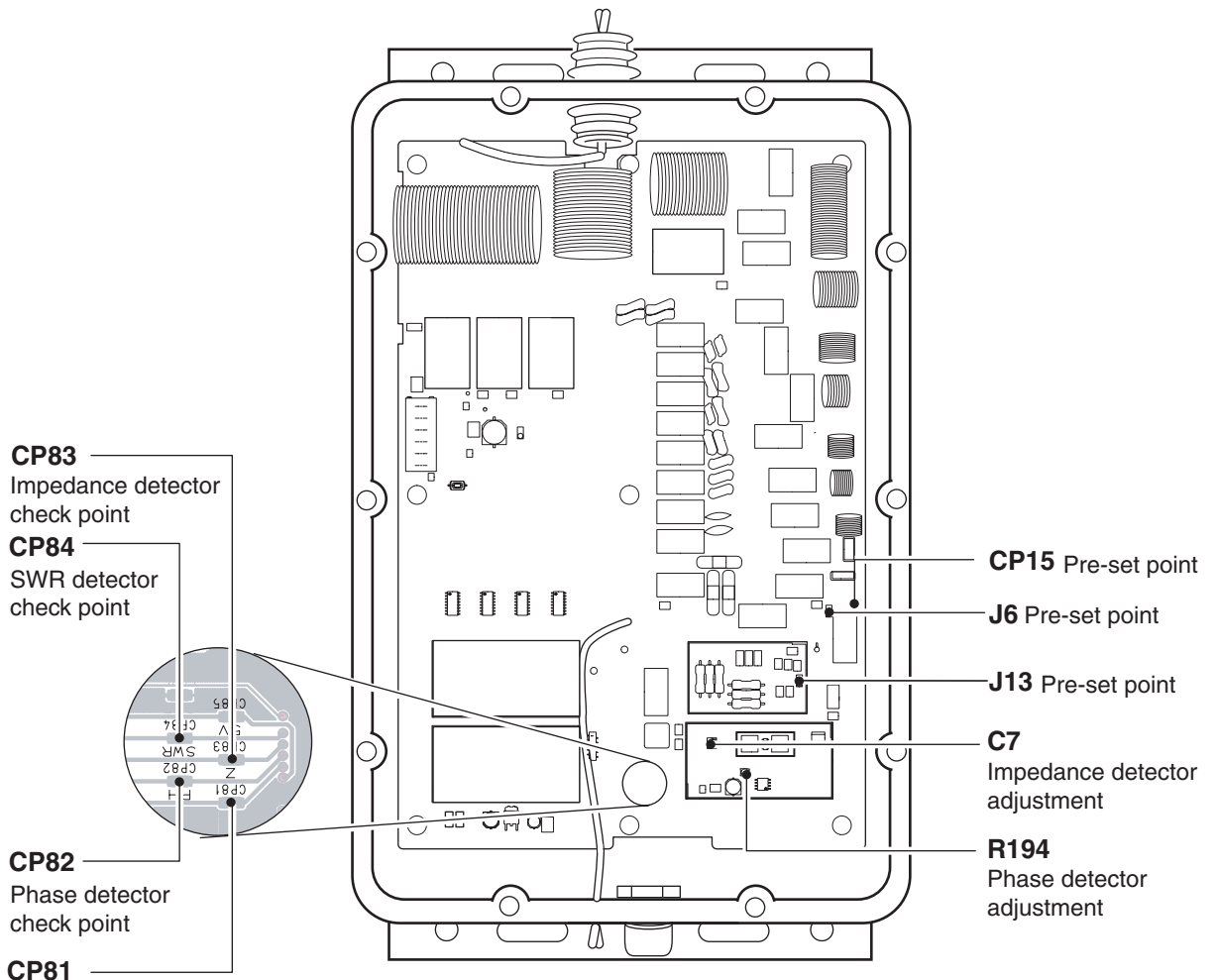





[TUNER-1 UNIT]

REF NO.	ORDER NO.	DESCRIPTION	M.	H/V LOCATION
R88	7030003400	S.RES ERJ3GEYJ 471 V (470)	T	80.2/164.8
R89	7030003400	S.RES ERJ3GEYJ 471 V (470)	T	80.2/162.5
R90	7030003400	S.RES ERJ3GEYJ 471 V (470)	T	80.2/160.2
R92	7030003400	S.RES ERJ3GEYJ 471 V (470)	T	80.2/157.9
R93	7030003400	S.RES ERJ3GEYJ 471 V (470)	T	80.2/155.6
R94	7030003400	S.RES ERJ3GEYJ 471 V (470)	T	80.2/153.3
R95	7030003400	S.RES ERJ3GEYJ 471 V (470)	T	80.2/151
R96	7030003400	S.RES ERJ3GEYJ 471 V (470)	T	80.2/148.7
R97	7030003400	S.RES ERJ3GEYJ 471 V (470)	T	80.2/146.4
R98	7030003400	S.RES ERJ3GEYJ 471 V (470)	T	80.2/144.1
R99	7030003400	S.RES ERJ3GEYJ 471 V (470)	T	80.2/141.8
R101	7030003400	S.RES ERJ3GEYJ 471 V (470)	T	80.2/139.5
R102	7030003400	S.RES ERJ3GEYJ 471 V (470)	T	80.2/137.2
R103	7030003400	S.RES ERJ3GEYJ 471 V (470)	T	80.2/134.9
R104	7030003400	S.RES ERJ3GEYJ 471 V (470)	T	80.2/132.6
R105	7030003400	S.RES ERJ3GEYJ 471 V (470)	T	80.2/130.3
R106	7030003400	S.RES ERJ3GEYJ 471 V (470)	T	80.2/128
R107	7030003400	S.RES ERJ3GEYJ 471 V (470)	T	80.2/125.7
R108	7030003400	S.RES ERJ3GEYJ 471 V (470)	T	80.2/123.4
R109	7030003240	S.RES ERJ3GEYJ 220 V (22)	T	105/34.4
R110	7030003240	S.RES ERJ3GEYJ 220 V (22)	T	119.9/33
R111	7030003240	S.RES ERJ3GEYJ 220 V (22)	T	134.9/38
R112	7030003240	S.RES ERJ3GEYJ 220 V (22)	T	149.9/39
R113	7030003240	S.RES ERJ3GEYJ 220 V (22)	T	167.6/41
R114	7030003240	S.RES ERJ3GEYJ 220 V (22)	T	182.2/33.8
R115	7030003240	S.RES ERJ3GEYJ 220 V (22)	T	199.3/34
R116	7030003240	S.RES ERJ3GEYJ 220 V (22)	T	234.2/53
R117	7030003240	S.RES ERJ3GEYJ 220 V (22)	T	258.7/49.1
R118	7030003240	S.RES ERJ3GEYJ 220 V (22)	T	274.8/31.7
R119	7030003240	S.RES ERJ3GEYJ 220 V (22)	T	262.6/32.7
R120	7030010620	S.RES ERJ12YJ180U (18)	T	192.5/130.2
R121	7030010620	S.RES ERJ12YJ180U (18)	T	192.5/149.9
R122	7030003240	S.RES ERJ3GEYJ 220 V (22)	T	98.5/32.4
R123	7030003240	S.RES ERJ3GEYJ 220 V (22)	T	105.7/87.8
R124	7030003240	S.RES ERJ3GEYJ 220 V (22)	T	126.4/89.6
R125	7030003240	S.RES ERJ3GEYJ 220 V (22)	T	138.9/89.6
R126	7030003240	S.RES ERJ3GEYJ 220 V (22)	T	151.4/89.6
R127	7030003240	S.RES ERJ3GEYJ 220 V (22)	T	163.9/89.6
R128	7030003240	S.RES ERJ3GEYJ 220 V (22)	T	176.4/89.6
R129	7030003240	S.RES ERJ3GEYJ 220 V (22)	T	188.9/89.6
R130	7030003240	S.RES ERJ3GEYJ 220 V (22)	T	201.5/89.6
R131	7030003240	S.RES ERJ3GEYJ 220 V (22)	T	213.5/89.8
R132	7030010620	S.RES ERJ12YJ180U (18)	T	241/66.8
R133	7030010620	S.RES ERJ12YJ180U (18)	T	192.5/162.1
R149	7030003400	S.RES ERJ3GEYJ 471 V (470)	T	80.2/176.3
R150	7030003520	S.RES ERJ3GEYJ 472 V (4.7 k)	T	24.5/51
R151	7030003480	S.RES ERJ3GEYJ 222 V (2.2 k)	T	39.6/59.4
R156	7030003640	S.RES ERJ3GEYJ 473 V (47 k)	T	133.3/183.1
R157	7030005521	S.RES ERA3YKD 334V (330 k)	T	34.9/174
R159	7030003560	S.RES ERJ3GEYJ 103 V (10 k)	T	67.2/159.5
R160	7030003400	S.RES ERJ3GEYJ 471 V (470)	T	69.2/159.1
R162	7030003640	S.RES ERJ3GEYJ 473 V (47 k)	T	31.3/165.8
R163	7030003680	S.RES ERJ3GEYJ 104 V (100 k)	T	38.4/124.4
R167	7030003520	S.RES ERJ3GEYJ 472 V (4.7 k)	T	167.7/125.9
R168	7030003520	S.RES ERJ3GEYJ 472 V (4.7 k)	T	165.9/121.3
R169	7030003520	S.RES ERJ3GEYJ 472 V (4.7 k)	T	164.3/125.7
R170	7030003520	S.RES ERJ3GEYJ 472 V (4.7 k)	T	162.4/121.3
R171	7030003520	S.RES ERJ3GEYJ 472 V (4.7 k)	T	160.7/125.8
R172	7030003520	S.RES ERJ3GEYJ 472 V (4.7 k)	T	158.9/121.3
R173	7030003520	S.RES ERJ3GEYJ 472 V (4.7 k)	T	157/125.9
R174	7030003520	S.RES ERJ3GEYJ 472 V (4.7 k)	T	155.4/121.3
R175	7030003520	S.RES ERJ3GEYJ 472 V (4.7 k)	T	153.7/125.8
R176	7030003520	S.RES ERJ3GEYJ 472 V (4.7 k)	T	151.9/121.3
R177	7030003520	S.RES ERJ3GEYJ 472 V (4.7 k)	T	150.2/125.8
R178	7030003520	S.RES ERJ3GEYJ 472 V (4.7 k)	T	148.4/121.4
R179	7030003520	S.RES ERJ3GEYJ 472 V (4.7 k)	T	167/152.4
R180	7030003520	S.RES ERJ3GEYJ 472 V (4.7 k)	T	164/156.3
R181	7030003520	S.RES ERJ3GEYJ 472 V (4.7 k)	T	148.4/152.4
R182	7030003520	S.RES ERJ3GEYJ 472 V (4.7 k)	T	150.2/156.3
R183	7030003520	S.RES ERJ3GEYJ 472 V (4.7 k)	T	151.9/152.5
R184	7030003520	S.RES ERJ3GEYJ 472 V (4.7 k)	T	153.6/156.3
R185	7030003520	S.RES ERJ3GEYJ 472 V (4.7 k)	T	155.3/152.5
R186	7030003520	S.RES ERJ3GEYJ 472 V (4.7 k)	T	157.1/156.3
R187	7030003520	S.RES ERJ3GEYJ 472 V (4.7 k)	T	158.9/152.5
R188	7030003520	S.RES ERJ3GEYJ 472 V (4.7 k)	T	160.6/156.3
R189	7030003520	S.RES ERJ3GEYJ 472 V (4.7 k)	T	162.5/152.5
R190	7030006070	S.RES ERJ12YJ101U (100)	T	77.6/28.9
R191	7030003480	S.RES ERJ3GEYJ 222 V (2.2 k)	T	26.4/33
R192	7030003550	S.RES ERJ3GEYJ 822 V (8.2 k)	T	29.6/36.3
R193	7030003740	S.RES ERJ3GEYJ 334 V (330 k)	T	28.3/49.2
R194	7310005020	S.TRI RH03ADC14X (10 k)	T	32.5/51.1
R195	7030003440	S.RES ERJ3GEYJ 102 V (1 k)	T	24.7/71.9
R196	7030003530	S.RES ERJ3GEYJ 562 V (5.6 k)	T	30.8/71.9
R198	7030003650	S.RES ERJ3GEYJ 563 V (56 k)	T	131.6/189.4
R200	7030003680	S.RES ERJ3GEYJ 104 V (100 k)	T	24.9/173.3
R201	7030003440	S.RES ERJ3GEYJ 102 V (1 k)	T	33.7/135.1
R202	7030003720	S.RES ERJ3GEYJ 224 V (220 k)	T	46.4/126.9
R203	7030003640	S.RES ERJ3GEYJ 473 V (47 k)	T	25/176.3
R204	7030003640	S.RES ERJ3GEYJ 473 V (47 k)	T	23.1/178.5
R205	7410000352	ARY RGLD3X104J		
R206	7410000352	ARY RGLD3X104J		
R207	7410000352	ARY RGLD3X104J		

[TUNER-1 UNIT]

REF NO.	ORDER NO.	DESCRIPTION	M.	H/V LOCATION
R208	7410000352	ARY RGLD3X104J		
R209	7410000352	ARY RGLD3X104J		
R210	7030003480	S.RES ERJ3GEYJ 222 V (2.2 k)	T	72/123.4
R211	7030003480	S.RES ERJ3GEYJ 222 V (2.2 k)	T	72/125.7
R212	7030003480	S.RES ERJ3GEYJ 222 V (2.2 k)	T	72/128
R213	7030003480	S.RES ERJ3GEYJ 222 V (2.2 k)	T	72/130.3
R214	7030003480	S.RES ERJ3GEYJ 222 V (2.2 k)	T	72/132.6
R215	7030003480	S.RES ERJ3GEYJ 222 V (2.2 k)	T	72/134.9
R216	7030003480	S.RES ERJ3GEYJ 222 V (2.2 k)	T	72/137.2
R217	7030003480	S.RES ERJ3GEYJ 222 V (2.2 k)	T	72/139.5
R218	7030003480	S.RES ERJ3GEYJ 222 V (2.2 k)	T	72/162.5
R219	7030003480	S.RES ERJ3GEYJ 222 V (2.2 k)	T	72/160.2
R220	7030003480	S.RES ERJ3GEYJ 222 V (2.2 k)	T	72/164.8
R221	7030003480	S.RES ERJ3GEYJ 222 V (2.2 k)	T	72/167.1
R222	7030003480	S.RES ERJ3GEYJ 222 V (2.2 k)	T	72/169.4
R223	7030003480	S.RES ERJ3GEYJ 222 V (2.2 k)	T	72/171.7
R224	7030003480	S.RES ERJ3GEYJ 222 V (2.2 k)	T	72/174
R225	7030003480	S.RES ERJ3GEYJ 222 V (2.2 k)	T	72/174.8
R226	7030003480	S.RES ERJ3GEYJ 222 V (2.2 k)	T	72/174.1
R227	7030003480	S.RES ERJ3GEYJ 222 V (2.2 k)	T	72/146.4
R228	7030003480	S.RES ERJ3GEYJ 222 V (2.2 k)	T	72/148.7
R229	7030003480	S.RES ERJ3GEYJ 222 V (2.2 k)	T	72/151
R230	7030003480	S.RES ERJ3GEYJ 222 V (2.2 k)	T	72/153.3
R231	7030003480	S.RES ERJ3GEYJ 222 V (2.2 k)	T	72/155.6
R232	7030003480	S.RES ERJ3GEYJ 222 V (2.2 k)	T	72/157.9
R235	7030005521	S.RES ERA3YKD 334V (330 k)	T	44.9/129.6
R236	7030003560	S.RES ERJ3GEYJ 103 V (10 k)	T	47.8/140.5
R237	7030003560	S.RES ERJ3GEYJ 103 V (10 k)	T	47.8/142
R238	7030003520	S.RES ERJ3GEYJ 472 V (4.7 k)	T	47.7/144.6
R239	7030003560	S.RES ERJ3GEYJ 103 V (10 k)	T	39.8/124.4
R240	7030003560	S.RES ERJ3GEYJ 103 V (10 k)	T	27.9/151.3
R242	7030003860	S.RES ERJ3GE JPW V	T	27.9/155.2
R243	7030003860	S.RES ERJ3GE JPW V	T	27.9/153.9
R244	7030003860	S.RES ERJ3GE JPW V	T	27.9/152.6
R248	7030003640	S.RES ERJ3GEYJ 473 V (47 k)	T	40.5/165.5
R249	7030003640	S.RES ERJ3GEYJ 473 V (47 k)	T	40.5/162.9
R250	7030003640	S.RES ERJ3GEYJ 473 V (47 k)	T	40.5/164.2
R251	7030003640	S.RES ERJ3GEYJ 473 V (47 k)	T	47.7/157.5
R252	7030003640	S.RES ERJ3GEYJ 473 V (47 k)	T	34.7/162.4
R253	7030007911	S.RES ERA3YKD 563V (56 k)	T	34.2/170.7
R255	7030010610	S.RES ERJ1TYJ 470U (47)	T	12.5/171.9
R256	7030003860	S.RES ERJ3GE JPW V	T	67.5/178.5
R257	7030003860	S.RES ERJ3GE JPW V	T	42.3/170
R258	7030010520	S.RES ERJ1TYJ 101U (100)	T	217.4/191.1
R259	7030003620	S.RES ERJ3GEYJ 333 V (33 k)	T	209.3/190.3
R262	7030010520	S.RES ERJ1TYJ 101U (100)	T	213.7/191.1
R263	7030010520	S.RES ERJ1TYJ 101U (100)	T	221.1/191.1
C1	4030006880	S.CER C1608 JB 1H 472K-T	T	42.2/68.5
C2	4030011120	S.CER GRM31M2C2H100JV01L	T	44.7/95.5
C3	4030007170	S.CER C1608 CH 1H 221J-T	T	40.6/93.7
C4	4030010760	S.CER C1608 CH 1H 331J-T	T	40.6/96.5
C6	4030011070	S.CER GRM31M2C2H5ROC2Y1L	T	49.3/60.9
C7	4610001160	S.TRI ECR-JA010 A11W	T	44.8/85.1
C8	4030007160	S.CER C1608 CH 1H 181J-T	T	39.5/65.1
C9	4510008690	S.ELE EEE1EA330SP	T	26.3/56
C10	4030006880	S.CER C1608 JB 1H 472K-T	T	24.4/49.2
C11	4030005110	S.CER C2012 JB 1E 473K-T	T	51.1/48.7
C12	4030010760	S.CER C1608 CH 1H 331J-T	T	37.6/60.3
C13	4030010760	S.CER C1608 CH 1H 331J-T	T	33.4/27.3
C14	4030005110	S.CER C2012 JB 1E 473K-T	T	47.1/27.9
C15	4030006880	S.CER C1608 JB 1H 472K-T	T	30.1/38.4
C16	4030006880	S.CER C1608 JB 1H 472K-T	T	37.6/57.2
C17	4030011600	S.CER C1608 JB 1E 104K-T	T	30.6/30.1
C18	4030005110	S.CER C2012 JB 1E 473K-T	T	32.5/15.8
C19	4030007010	S.CER C1608 CH 1H 100D-T	T	59.5/21.5
C20	4030008560	S.CER C1608 CH 1H 300J-T	T	59.5/19
C21	4030010760	S.CER C1608 CH 1H 331J-T	T	29.8/19.1
C22	4030006880	S.CER C1608 JB 1H 472K-T	T	24.9/27.1
C23	4030005110	S.CER C2012 JB 1E 473K-T	T	38.6/24.3
C24	4320001230	S.MIC UC552H 1201J-T	T	108.6/64.5
C25	4320001230	S.MIC UC552H 1201J-T	T	108.6/58
C26	4320001230	S.MIC UC552H 1201J-T	T	121.5/61.9
C28	4010008720	CER DEA1X3D271JA2B		
C29	4010008710	CER DEA1X3D31JA3B		
C30	4010008560	CER DEA1X3F151JA3B		
C31	4010008560	CER DEA1X3F151JA3B		
C32	4010008560	CER DEA1X3F151JA3B		
C34	4030006880	S.CER C1608 JB 1H 472K-T	T	100.7/30.2
C35	4010008560	CER DEA1X3F151JA3B		
C36	4010008560	CER DEA1X3F151JA3B		
C37	4010004790	CER DEC1X3J680JC4B		
C38	4010008680	CER DEA1X3F820JA3B		
C39	4010004770	CER DEC1X3J390JC4B		
C40	4010004770	CER DEC1X3J390JC4B		
C41	4010008730	CER DEA1X3F180JCDB		
C42	4010008730	CER DEA1X3F180JCDB		
C43	4030006880	S.CER C1608 JB 1H 472K-T	T	105/92.5
C44	4010004810	CER DEC1X3J101JC4B		
C45	4010004810	CER DEC1X3J101JC4B		
C46	4010004810	CER DEC1X3J101JC4B		

M.=Mounted side (T: Mounted on the Top side, B: Mounted on the Bottom side)  
S.=Surface mount

**[TUNER-1 UNIT]**

REF NO.	ORDER NO.	DESCRIPTION	M.	H/V LOCATION
C47	4010004810	CER DEC1X3J101JC4B		
C48	4030006880	S.CER C1608 JB 1H 472K-T	T	99.9/8.2
C50	4030008960	S.CER C2012 JB 1C 104K-T	T	36.1/40.9
C53	4510008570	S.ELE EEE1CA220SR	T	11.6/140.4
C54	4030006880	S.CER C1608 JB 1H 472K-T	T	10.1/145.3
C55	4030006880	S.CER C1608 JB 1H 472K-T	T	9.7/154.5
C56	4510008520	S.ELE EEE1CA470SP	T	12.3/158.7
C58	4030006880	S.CER C1608 JB 1H 472K-T	T	185.3/165.3
C59	4030005110	S.CER C2012 JB 1E 473K-T	T	185.4/163.3
C60	4510008510	S.ELE EEE1CA471P	T	176.5/157.3
C62	4030006880	S.CER C1608 JB 1H 472K-T	T	151.5/182.5
C64	4030006880	S.CER C1608 JB 1H 472K-T	T	151.6/184
C65	4030006880	S.CER C1608 JB 1H 472K-T	T	37.7/172.8
C68	4030006880	S.CER C1608 JB 1H 472K-T	T	23.1/129.1
C73	4030006880	S.CER C1608 JB 1H 472K-T	T	26.9/178.5
C74	4030006880	S.CER C1608 JB 1H 472K-T	T	23.1/123.3
C75	4340000390	S.MLR ECWU1H224JC9	T	43.2/173.1
C76	4030006880	S.CER C1608 JB 1H 472K-T	T	36.5/140.7
C77	4030006880	S.CER C1608 JB 1H 472K-T	T	36.5/142
C78	4030006850	S.CER C1608 JB 1H 471K-T	T	24.4/161
C79	4030006850	S.CER C1608 JB 1H 471K-T	T	24.4/165.2
C81	4030006880	S.CER C1608 JB 1H 472K-T	T	27.9/157.8
C82	4510008540	S.ELE EEE1CA100SR	T	23.8/155.4
C84	4340000390	S.MLR ECWU1H224JC9	T	39.3/133.4
C85	4340000390	S.MLR ECWU1H224JC9	T	35.7/179.6
C86	4030006860	S.CER C1608 JB 1H 102K-T	T	48.6/125
C87	4030008560	S.CER C1608 CH 1H 300J-T	T	29.9/146.5
C88	4030008560	S.CER C1608 CH 1H 300J-T	T	29.9/143.4
C89	4030006880	S.CER C1608 JB 1H 472K-T	T	80.2/178.6
C91	4030006880	S.CER C1608 JB 1H 472K-T	T	67.6/150.9
C94	4030006880	S.CER C1608 JB 1H 472K-T	T	67.6/131.7
C98	4030006880	S.CER C1608 JB 1H 472K-T	T	110.8/40
C100	4030006880	S.CER C1608 JB 1H 472K-T	T	125.5/36.7
C102	4030006880	S.CER C1608 JB 1H 472K-T	T	140.5/41.6
C104	4030006880	S.CER C1608 JB 1H 472K-T	T	155/42.4
C106	4030006880	S.CER C1608 JB 1H 472K-T	T	167.6/45.1
C108	4030006880	S.CER C1608 JB 1H 472K-T	T	185.1/33.2
C110	4030006880	S.CER C1608 JB 1H 472K-T	T	199.3/35.5
C112	4030006880	S.CER C1608 JB 1H 472K-T	T	229.7/56.7
C114	4030006880	S.CER C1608 JB 1H 472K-T	T	251.5/53.5
C116	4030006880	S.CER C1608 JB 1H 472K-T	T	271.8/33.9
C118	4030006880	S.CER C1608 JB 1H 472K-T	T	275.6/33.9
C120	4030006880	S.CER C1608 JB 1H 472K-T	T	110.9/90.2
C122	4030006880	S.CER C1608 JB 1H 472K-T	T	129/90.3
C124	4030006880	S.CER C1608 JB 1H 472K-T	T	141.6/90.4
C126	4030006880	S.CER C1608 JB 1H 472K-T	T	154.8/90.3
C128	4030006880	S.CER C1608 JB 1H 472K-T	T	167.4/90.4
C130	4030006880	S.CER C1608 JB 1H 472K-T	T	179.7/90.3
C132	4030006880	S.CER C1608 JB 1H 472K-T	T	192/90.7
C134	4030006880	S.CER C1608 JB 1H 472K-T	T	204.3/90.3
C136	4030006880	S.CER C1608 JB 1H 472K-T	T	216.8/90.5
C147	4030006880	S.CER C1608 JB 1H 472K-T	T	193.4/134.5
C148	4030006880	S.CER C1608 JB 1H 472K-T	T	65.9/159.5
C150	4030006880	S.CER C1608 JB 1H 472K-T	T	250/58.3
C152	4030006880	S.CER C1608 JB 1H 472K-T	T	193.4/154.1
C153	4030006880	S.CER C1608 JB 1H 472K-T	T	76.6/176.3
C155	4030006880	S.CER C1608 JB 1H 472K-T	T	193.2/174.6
C162	4030011120	S.CER GRM31M2C2H100JV01L	T	74.1/5.8
C164	4030006880	S.CER C1608 JB 1H 472K-T	T	37/72.8
C165	4030006880	S.CER C1608 JB 1H 472K-T	T	25.4/19.2
C172	4030006880	S.CER C1608 JB 1H 472K-T	T	32.2/56.1
C173	4030006880	S.CER C1608 JB 1H 472K-T	T	24.6/38.4
C174	4030005110	S.CER C2012 JB 1E 473K-T	T	29.4/68.9
C176	4030006880	S.CER C1608 JB 1H 472K-T	T	173.4/170.7
C178	4030006880	S.CER C1608 JB 1H 472K-T	T	176.5/148.9
C179	4030006880	S.CER C1608 JB 1H 472K-T	T	102.7/27.5
C181	4030006880	S.CER C1608 JB 1H 472K-T	T	27/174
C182	4030006880	S.CER C1608 JB 1H 472K-T	T	76.6/123.4
C183	4030006880	S.CER C1608 JB 1H 472K-T	T	76.6/125.7
C184	4030006880	S.CER C1608 JB 1H 472K-T	T	76.6/128
C185	4030006880	S.CER C1608 JB 1H 472K-T	T	76.6/130.3
C186	4030006880	S.CER C1608 JB 1H 472K-T	T	76.6/132.6
C187	4030006880	S.CER C1608 JB 1H 472K-T	T	76.6/134.9
C188	4030006880	S.CER C1608 JB 1H 472K-T	T	76.6/137.2
C189	4030006880	S.CER C1608 JB 1H 472K-T	T	76.6/139.5
C190	4030006880	S.CER C1608 JB 1H 472K-T	T	76.6/160.2
C191	4030006880	S.CER C1608 JB 1H 472K-T	T	76.6/162.5
C192	4030006880	S.CER C1608 JB 1H 472K-T	T	76.6/164.8
C193	4030006880	S.CER C1608 JB 1H 472K-T	T	76.6/167.1
C194	4030006880	S.CER C1608 JB 1H 472K-T	T	76.6/169.4
C195	4030006880	S.CER C1608 JB 1H 472K-T	T	76.6/171.7
C196	4030006880	S.CER C1608 JB 1H 472K-T	T	76.6/174
C197	4030006880	S.CER C1608 JB 1H 472K-T	T	76.6/141.8
C198	4030006880	S.CER C1608 JB 1H 472K-T	T	76.6/144.1
C199	4030006880	S.CER C1608 JB 1H 472K-T	T	76.6/146.4
C200	4030006880	S.CER C1608 JB 1H 472K-T	T	76.6/148.7
C201	4030006880	S.CER C1608 JB 1H 472K-T	T	76.6/151
C202	4030006880	S.CER C1608 JB 1H 472K-T	T	76.6/153.3
C203	4030006880	S.CER C1608 JB 1H 472K-T	T	76.6/155.6
C204	4030006880	S.CER C1608 JB 1H 472K-T	T	76.6/157.9
C205	4030006880	S.CER C1608 JB 1H 472K-T	T	83.8/123.4
C206	4030006880	S.CER C1608 JB 1H 472K-T	T	83.8/125.7

**[TUNER-1 UNIT]**

REF NO.	ORDER NO.	DESCRIPTION	M.	H/V LOCATION
C207	4030006880	S.CER C1608 JB 1H 472K-T	T	83.8/128
C208	4030006880	S.CER C1608 JB 1H 472K-T	T	83.8/130.3
C209	4030006880	S.CER C1608 JB 1H 472K-T	T	83.8/132.6
C210	4030006880	S.CER C1608 JB 1H 472K-T	T	83.8/134.9
C211	4030006880	S.CER C1608 JB 1H 472K-T	T	83.8/137.2
C212	4030006880	S.CER C1608 JB 1H 472K-T	T	108.5/123.9
C213	4030006880	S.CER C1608 JB 1H 472K-T	T	107.2/123.9
C214	4030006880	S.CER C1608 JB 1H 472K-T	T	105.9/123.9
C215	4030006880	S.CER C1608 JB 1H 472K-T	T	104.6/123.9
C216	4030006880	S.CER C1608 JB 1H 472K-T	T	103.2/123.9
C217	4030006880	S.CER C1608 JB 1H 472K-T	T	101.9/123.9
C218	4030006880	S.CER C1608 JB 1H 472K-T	T	100.5/123.9
C219	4030006880	S.CER C1608 JB 1H 472K-T	T	108.5/139.3
C220	4030006880	S.CER C1608 JB 1H 472K-T	T	107.2/139.3
C221	4030006880	S.CER C1608 JB 1H 472K-T	T	105.9/139.3
C222	4030006880	S.CER C1608 JB 1H 472K-T	T	104.6/139.3
C223	4030006880	S.CER C1608 JB 1H 472K-T	T	103.3/139.3
C224	4030006880	S.CER C1608 JB 1H 472K-T	T	102/139.3
C225	4030006880	S.CER C1608 JB 1H 472K-T	T	100.7/139.3
C226	4030006880	S.CER C1608 JB 1H 472K-T	T	83.8/139.5
C227	4030006880	S.CER C1608 JB 1H 472K-T	T	83.8/141.8
C228	4030006880	S.CER C1608 JB 1H 472K-T	T	83.8/144.1
C229	4030006880	S.CER C1608 JB 1H 472K-T	T	83.8/146.4
C230	4030006880	S.CER C1608 JB 1H 472K-T	T	83.8/148.7
C231	4030006880	S.CER C1608 JB 1H 472K-T	T	83.8/151
C232	4030006880	S.CER C1608 JB 1H 472K-T	T	109.3/151.1
C256	4030006880	S.CER C1608 JB 1H 472K-T	T	83.8/164.8
C257	4030006880	S.CER C1608 JB 1H 472K-T	T	83.8/162.5
C258	4030006880	S.CER C1608 JB 1H 472K-T	T	83.8/160.2
C259	4030006880	S.CER C1608 JB 1H 472K-T	T	83.8/157.9
C260	4030006880	S.CER C1608 JB 1H 472K-T	T	83.8/155.6
C261	4030006880	S.CER C1608 JB 1H 472K-T	T	83.8/153.3
C262	4030006880	S.CER C1608 JB 1H 472K-T	T	104.6/168.8
C263	4030006880	S.CER C1608 JB 1H 472K-T	T	105.9/168.8
C264	4030006880	S.CER C1608 JB 1H 472K-T	T	107.2/168.8
C265	4030006880	S.CER C1608 JB 1H 472K-T	T	108.5/168.8
C266	4030006880	S.CER C1608 JB 1H 472K-T	T	100.7/154
C267	4030006880	S.CER C1608 JB 1H 472K-T	T	102/154
C268	4030006880	S.CER C1608 JB 1H 472K-T	T	103.3/154
C269	4030006880	S.CER C1608 JB 1H 472K-T	T	104.6/154
C270	4030006880	S.CER C1608 JB 1H 472K-T	T	105.9/153.9
C271	4030006880	S.CER C1608 JB 1H 472K-T	T	107.2/153.9
C272	4030006880	S.CER C1608 JB 1H 472K-T	T	108.5/153.9
C273	4030006880	S.CER C1608 JB 1H 472K-T	T	83.8/174
C274	4030006880	S.CER C1608 JB 1H 472K-T	T	83.8/171.7
C275	4030006880	S.CER C1608 JB 1H 472K-T	T	83.8/169.4
C276	4030006880	S.CER C1608 JB 1H 472K-T	T	83.8/167.1
C278	4030006880	S.CER C1608 JB 1H 472K-T	T	45/135.6
C279	4030011600	S.CER C1608 JB 1E 104K-T	T	33.2/142
C280	4030011600	S.CER C1608 JB 1E 104K-T	T	33.2/140.7
C281	4030011600	S.CER C1608 JB 1E 104K-T	T	127.1/183.5
C282	4030006880	S.CER C1608 JB 1H 472K-T	T	31.3/164.5
C283	4030006880	S.CER C1608 JB 1H 472K-T	T	31.3/170.7
C284	4030006880	S.CER C1608 JB 1H 472K-T	T	67.6/170
C285	4030011330	S.CER C1608 CH 1H 391J-T	T	210/192.3
C286	4030006880	S.CER C1608 JB 1H 472K-T	T	208.5/192.3
RL1	6330001070	RLY AJQ1341 B01		
RL2	6330001070	RLY AJQ1341 B01		
RL3	6330001060	RLY APQ 3311		
RL4	6330000570	RLY AR-39251		
RL5	6330001060	RLY APQ 3311		
RL6	6330001060	RLY APQ 3311		
RL7	6330001060	RLY APQ 3311		
RL8	6330001060	RLY APQ 3311		
RL9	6330001060	RLY APQ 3311		
RL10	6330001060	RLY APQ 3311		
RL11	6330001060	RLY APQ 3311		
RL12	6330001060	RLY APQ 3311		
RL13	6330001060	RLY APQ 3311		
RL14	6330001060	RLY APQ 3311		
RL15	6330001060	RLY APQ 3311		
RL16	6330001060	RLY APQ 3311		
RL17	6330001060	RLY APQ 3311		
RL18	6330001060	RLY APQ 3311		
RL19	6330001060	RLY APQ 3311		
RL20	6330001060	RLY APQ 3311		
RL21	6330001060	RLY APQ 3311		
RL22	6330001060	RLY APQ 3311		
RL23	6330001060	RLY APQ 3311		
RL24	6330001060	RLY APQ 3311		
RL25	6330000570	RLY AR-39251		
RL26	6330000570	RLY AR-39251		
RL27	6330000570	RLY AR-39251		
J4	6910003141	CNR IMSA-9202B-1-02Z041-PT1		
J6	6910003141	CNR IMSA-9202B-1-02Z041-PT1		
J13	6910003141	CNR IMSA-9202B-1-02Z041-PT1		
J16	6510003100	CNR RT01T-1.3M		
J19	6510022621	S.CNR 10FMN-MBTR-A-TBT (LF) (SN)	T	43.5/115.6

M.=Mounted side (T: Mounted on the Top side, B: Mounted on the Bottom side)

S.=Surface mount

[TUNER-1 UNIT]

REF NO.	ORDER NO.	DESCRIPTION	M.	H/V LOCATION
P4	6910003120	CNR IMSA-9206H-T		
P6	6910003120	CNR IMSA-9206H-T		
DS1	5040002620	S.LED SML-311UT T86	T	167.6/134.7
DS2	5040002620	S.LED SML-311UT T86	T	165.9/131.5
DS3	5040002620	S.LED SML-311UT T86	T	164.3/134.7
DS4	5040002620	S.LED SML-311UT T86	T	162.4/131.5
DS5	5040002620	S.LED SML-311UT T86	T	160.7/134.7
DS6	5040002620	S.LED SML-311UT T86	T	158.9/131.5
DS7	5040002620	S.LED SML-311UT T86	T	157/134.7
DS8	5040002620	S.LED SML-311UT T86	T	155.4/131.5
DS9	5040002620	S.LED SML-311UT T86	T	153.7/134.7
DS10	5040002620	S.LED SML-311UT T86	T	151.9/131.5
DS11	5040002620	S.LED SML-311UT T86	T	150.2/134.7
DS12	5040002620	S.LED SML-311UT T86	T	148.4/131.6
DS13	5040002620	S.LED SML-311UT T86	T	165.9/143
DS14	5040002620	S.LED SML-311UT T86	T	164.3/146.9
DS15	5040002620	S.LED SML-311UT T86	T	148.3/143
DS16	5040002620	S.LED SML-311UT T86	T	150.1/146.9
DS17	5040002620	S.LED SML-311UT T86	T	151.9/143
DS18	5040002620	S.LED SML-311UT T86	T	153.6/146.9
DS19	5040002620	S.LED SML-311UT T86	T	155.3/143
DS20	5040002620	S.LED SML-311UT T86	T	157.1/146.9
DS21	5040002620	S.LED SML-311UT T86	T	158.9/143
DS22	5040002620	S.LED SML-311UT T86	T	160.6/146.9
DS23	5040002620	S.LED SML-311UT T86	T	162.5/143
DS24	5040002620	S.LED SML-311UT T86	T	127/185.1
S2	2260001890	S.SW SKQDPA	T	154/172.9
W18	9011570360	WIR 35/00/110/W06/W06		
W61	9011570370	WIR 99/02/170/W06/W06UL3239		

[CHASS UNIT]

REF NO.	ORDER NO.	DESCRIPTION	M.	H/V LOCATION
W501	8900014990	CBL OPC-1468		
W502	8900011400	CBL OPC-1164		

M.=Mounted side (T: Mounted on the Top side, B: Mounted on the Bottom side)  
S.=Surface mount

# SECTION 6 MECHANICAL PARTS AND DISASSEMBLY

## [CHASSIS PARTS]

REF. NO.	ORDER NO.	DESCRIPTION	QTY.
W501	8900011380	Cable OPC-1146	1
W502	8900011400	Cable OPC-1164	1
EP501	6910000880	Sheet NC-1 (SUS)	1
EP502	6910000880	Sheet NC-1 (SUS)	1
MP501	8310006540	High voltage waring seal	1
MP502	8010019030	1157 U-case	1
MP503	8010019020	1157 L-case	1
MP504	8930006900	Mounting plate	2
MP505	8930006540	Waterproof seal	1
MP506	8930002800	O ring (G)	2
MP507	8930006550	Sealing washer (A)	1
MP508	8930006560	Sealing washer (C)	1
MP509	8930006570	Sealing washer (D)	4
MP510	6910000470	Pair insulator	1
MP512	8310066500	Caution seal (P)	1
MP517	8810000620	Screw PH M3 × 13 SUS	1
MP518	8830000230	Nut M3 SUS	1
MP519	8810003480	Hex head bolt M5 × 60 SUS	1
MP520	8860000160	Earth lug B8 (M5) AG BS	1
MP521	8850000500	Spring washer M5 SUS	1
MP522	8850000180	Flat washer M5 SUS	1
MP523	8830000250	Nut M5 SUS	1
MP524	8860000190	Earth lug (M5) AG BS	1
MP525	8850000600	Gear Washer M5 SUS	1
MP526	8830000370	Wing nut M5 SUS	1
MP527	8810003470	Hex head bolt M5 × 20 SUS	1
MP528	8860000160	Earth lug B8 (M5) AG BS	1
MP529	8850000500	Spring washer M5 SUS	1
MP530	8850000180	Flat washer M5 SUS	1
MP531	8830000250	Nut M5 SUS	1
MP532	8860000190	Earth lug D5 (M5) AG BS	1
MP533	8850000600	Gear Washer M5 SUS	1
MP534	8830000370	Wing nut M5 SUS	1
MP535	8810002800	Screw PH M5 × 10 SUS	4
MP536	8810000660	Screw PH M4 × 14 SUS	10
MP537	8810001480	Screw PH A M5 × 10 SUS	2
MP538	8810001691	Screw PH B0 3 × 8 (PL)	9
MP539	8830000240	Nut M4 SUS	10
MP541	8930006570	Sealing washer (D)	1
MP544	8930006570	Sealing washer (D)	1
MP551	8950001980	Cable tie-140	1
MP552	6910014570	Super ground (FGA13-08B)	1
MP553	6910014570	Super ground (FGA13-08B)	1

## [TUNER-1 UNIT]

REF. NO.	ORDER NO.	DESCRIPTION	QTY.
MP3	8510001101	Shield case (A) cover (A)-1	1
MP4	8510001081	Shield case (A)-1	1
MP6	8510003500	406 shield case	1
MP7	8510002020	MIX shield case	1
MP11	8510003500	406 shield case	1
MP12	8510003510	406 shield case cover	1
MP22	8510003500	406 shield case	1
MP23	8510003510	406 shield case cover	1

## [ACCESSORIES]

REF. NO.	ORDER NO.	DESCRIPTION	QTY.
W701	8900004200	Cable OPC-412	1
J701	6510002030	Connector 1380T	4
P702	6510001930	1490P1	1
MP701	8820000440	U-bolt A SUS	2
MP702	8010000010	U-bolt plate	2
MP703	8830000260	Nut M6 SUS	8
MP704	8850000510	Spring washer M6 SUS	8
MP705	8850000190	Flat washer M6 SUS	4
MP706	8810001500	Screw PH A M6 × 30 SUS	4
MP707	8810003500	Hex head bolt M6 × 50 SUS	4
MP708	8850000200	Flat washer M6 SUS	8
MP711	6950000010	Waterproof cap	1

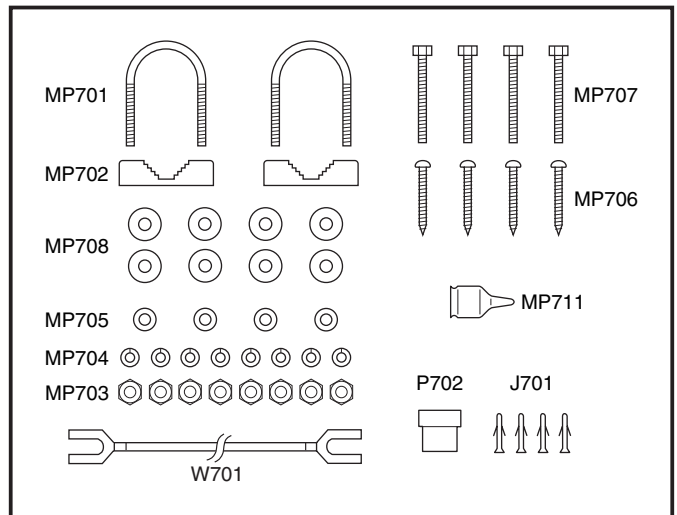

### Screw abbreviations

A,B0,B1: Self-tapping  
 PH: Pan head      BS: Brass  
 NI: Nickel          SUS: Stainless

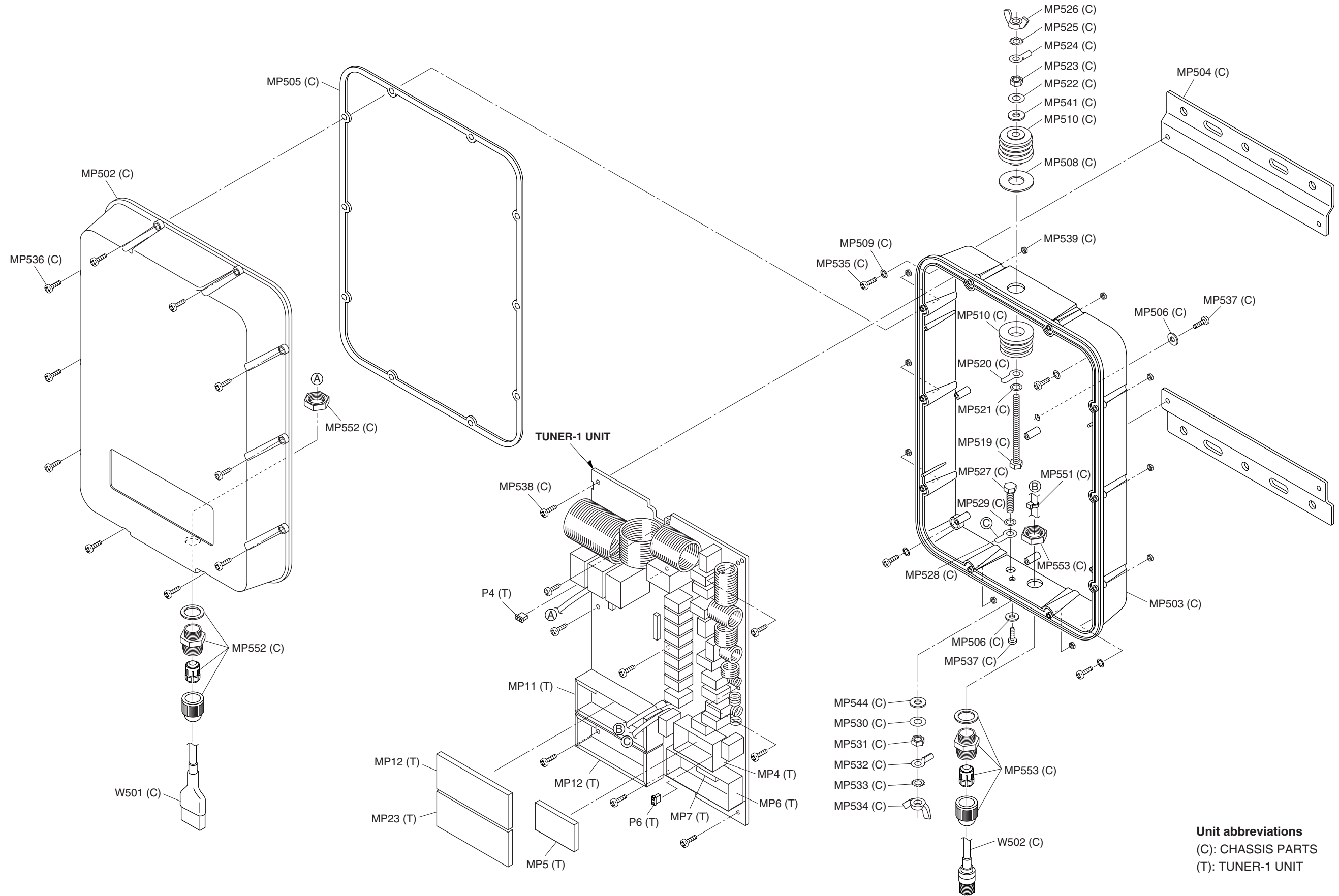

**Unit abbreviations**  
 (C): CHASSIS PARTS  
 (T): TUNER-1 UNIT

## SECTION 7 SEMICONDUCTOR INFORMATION

### • TRANSISTORS AND FET'S

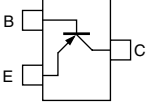
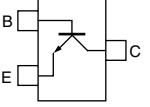
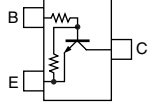
<p><b>2SA1586 GR</b> (Symbol: SG)</p> 	<p><b>2SC4116 GR</b> (Symbol: LG)</p> 	<p><b>DTC144EUA T106</b> (Symbol: 26_)</p> 		
---	---	--	--	--

### • DIODES

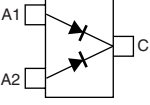
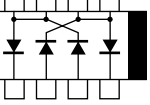
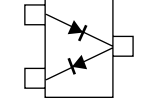
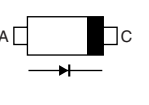
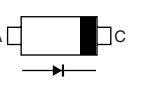
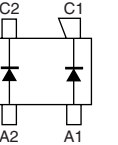
<p><b>1SS301</b> (Symbol: B3)</p> 	<p><b>HSB88WSTR</b> (Symbol: Silver line)</p> 	<p><b>HSM88AS TR</b> (Symbol: C1)</p> 	<p><b>MA2S111</b> (Symbol: A)</p> 	<p><b>MA732</b> (Symbol: 2C)</p> 
<p><b>MA862</b> (Symbol: M11)</p> 				

# SECTION 8 BOARD LAYOUT

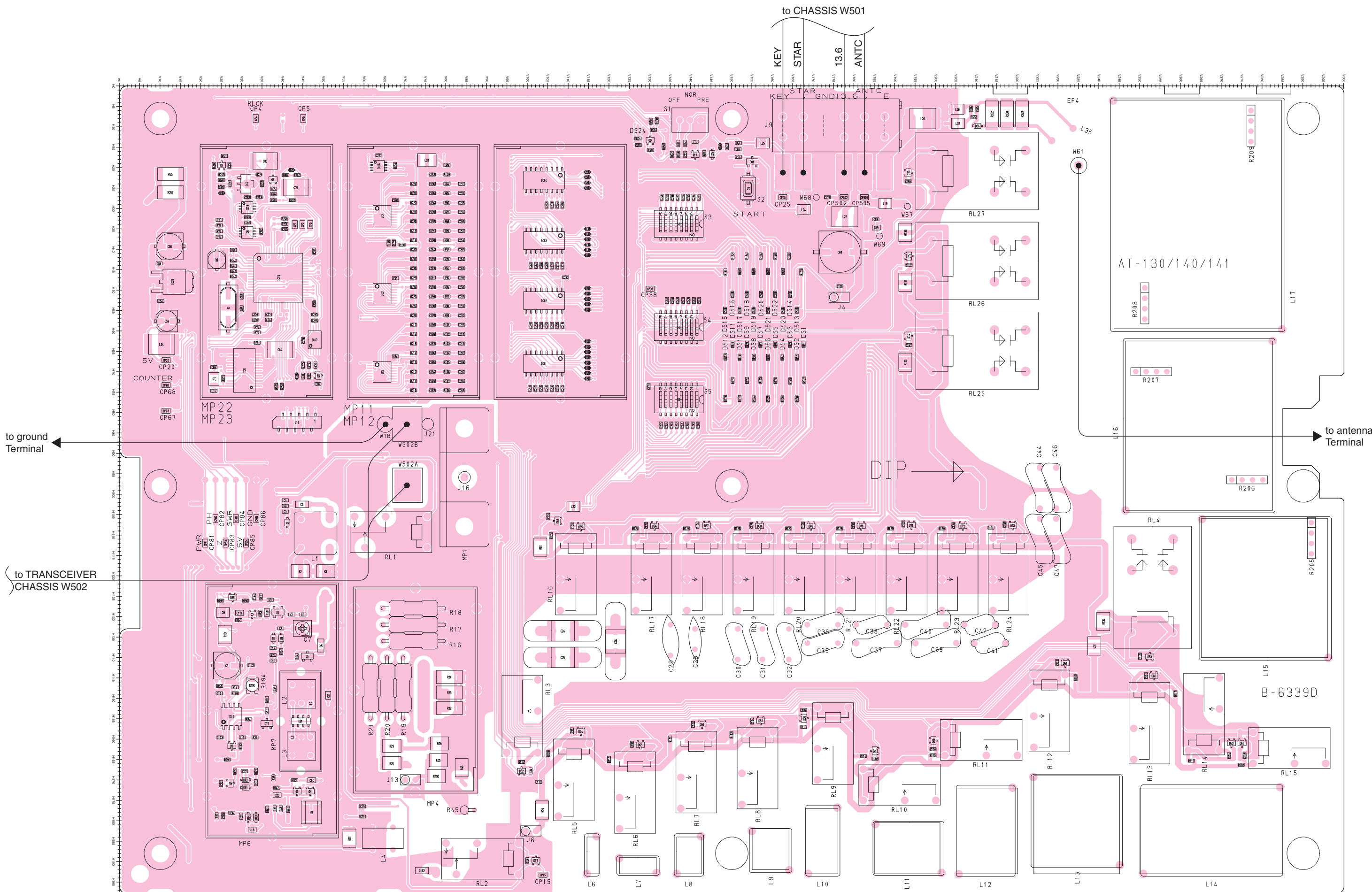

# SECTION 9 BLOCK DIAGRAM

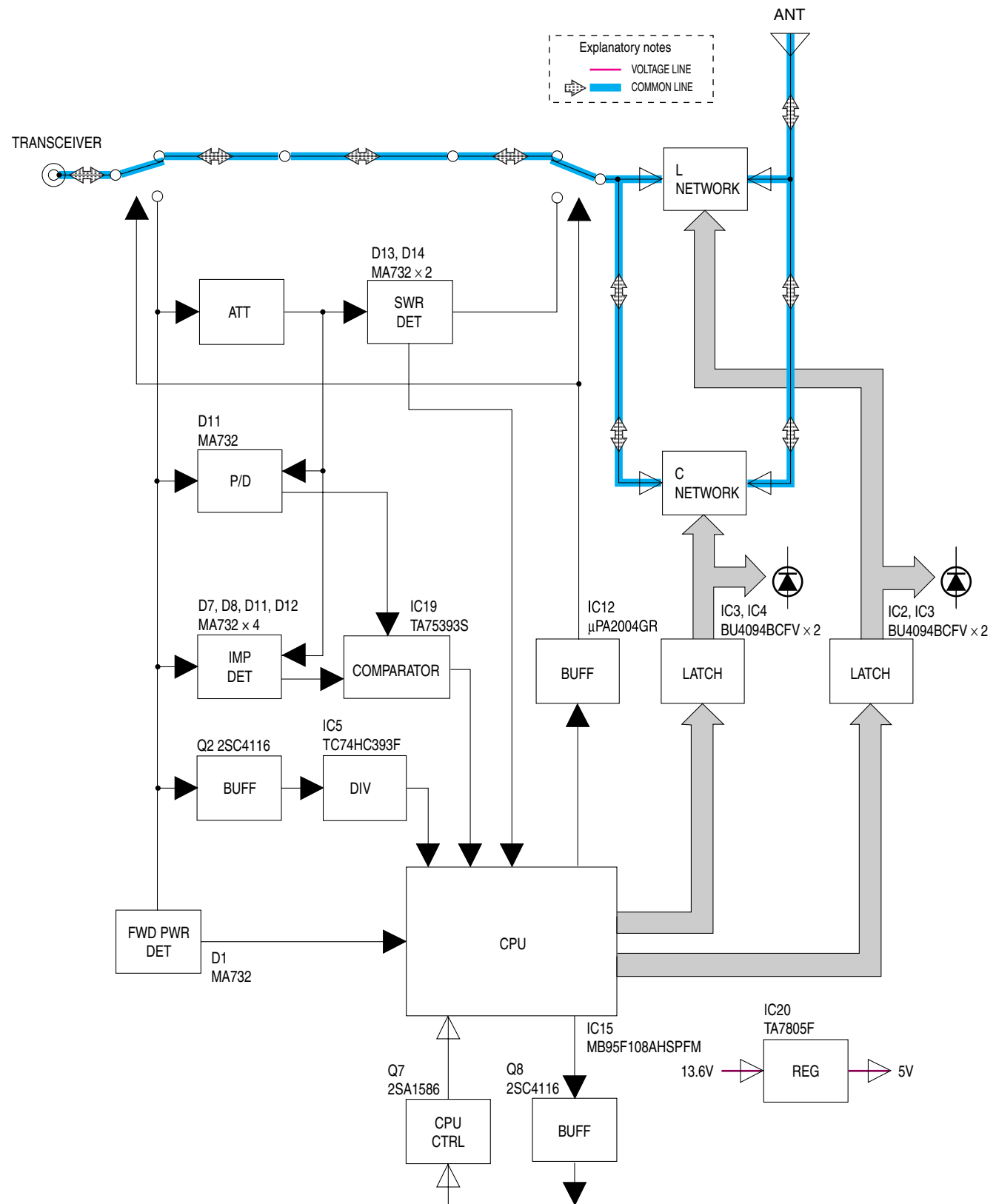



# SECTION 10 VOLTAGE DIAGRAM

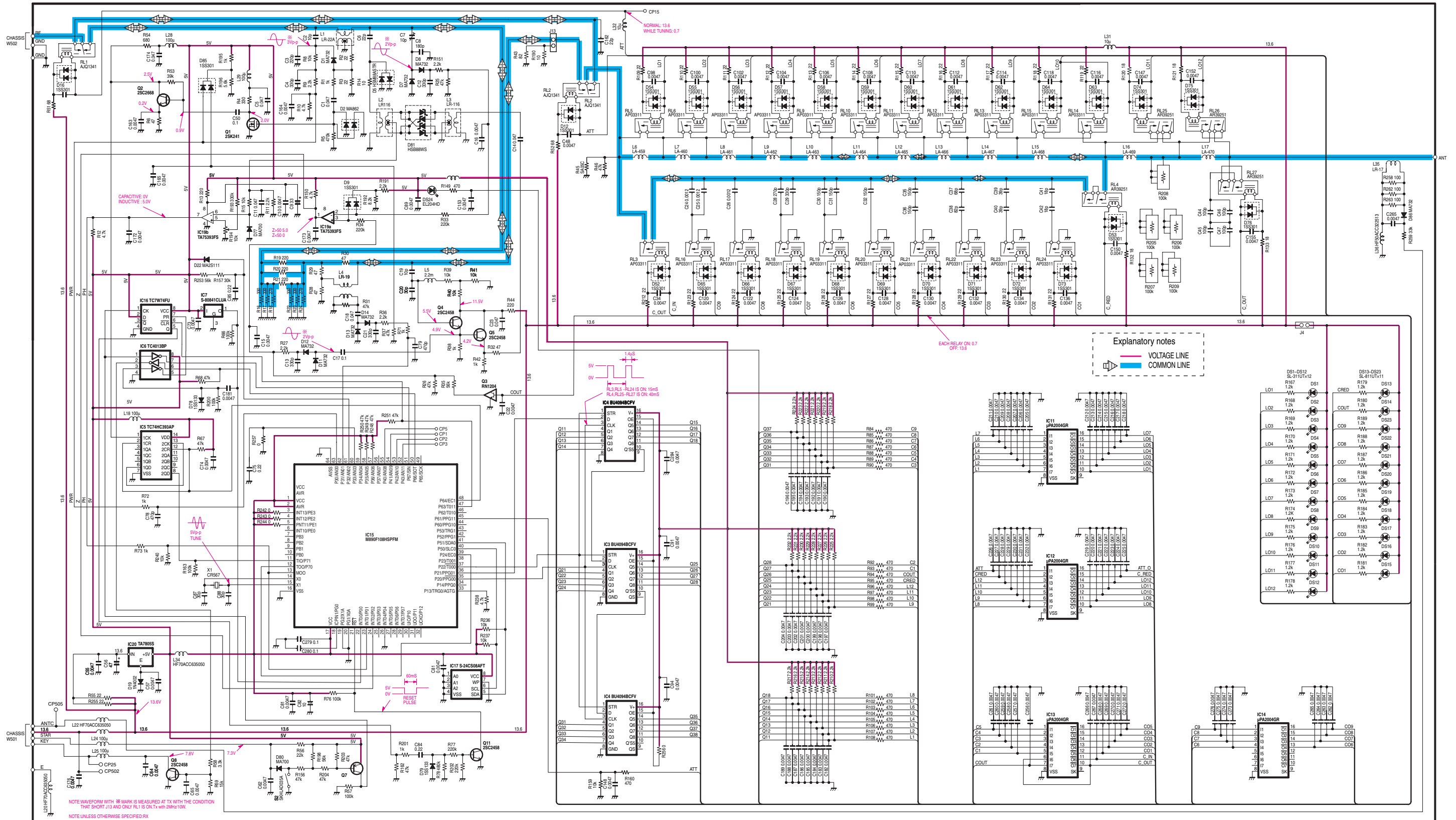

## Icom Inc.

1-1-32, Kamiminami, Hirano-ku, Osaka 547-0003, Japan  
Phone : +81 (06) 6793 5302  
Fax : +81 (06) 6793 0013  
URL : <http://www.icom.co.jp/world/index.html>

### Icom America Inc.

<Corporate Headquarters>  
2380 116th Avenue N.E., Bellevue, WA 98004, U.S.A.  
Phone : +1 (425) 454-8155 Fax : +1 (425) 454-1509  
URL : <http://www.icomamerica.com>  
E-mail : [sales@icomamerica.com](mailto:sales@icomamerica.com)  
<Customer Service>  
Phone : +1 (425) 454-7619

### Icom Canada

Glenwood Centre #150-6165  
Highway 17 Delta, B.C., V4K 5B8, Canada  
Phone : +1 (604) 952-4266 Fax : +1 (604) 952-0090  
URL : <http://www.icomcanada.com>  
E-mail : [info@icomcanada.com](mailto:info@icomcanada.com)

### Icom (Australia) Pty. Ltd.

Unit 1 / 103 Garden Road, Clayton VIC 3168 Australia  
Phone : +61 (03) 9549-7500 Fax : +61 (03) 9549-7505  
URL : <http://www.icom.net.au>  
E-mail : [sales@icom.net.au](mailto:sales@icom.net.au)

### Icom New Zealand

146A Harris Road, East Tamaki,  
Auckland, New Zealand  
Phone : +64 (09) 274 4062 Fax : +64 (09) 274 4708  
URL : <http://www.icom.co.nz>  
E-mail : [inquiries@icom.co.nz](mailto:inquiries@icom.co.nz)

### Beijing Icom Ltd.

10C07, Long silver Mansion, No.88, Yong Ding  
Road, Haidian District, Beijing, 100039, China  
Phone : +86 (010) 5889 5391/5392/5393  
Fax : +86 (010) 5889 5395  
E-mail : [bjicom@bjicom.com](mailto:bjicom@bjicom.com)  
URL : <http://www.bjicom.com>

### Icom (Europe) GmbH

Communication Equipment  
Auf der Krautweide 24  
65812 Bad Soden am Taunus, Germany  
Phone : +49 (6196) 76685-0 Fax : +49 (6196) 76685-50  
URL : <http://www.icomeurope.com>  
E-mail : [info@icomeurope.com](mailto:info@icomeurope.com)

### Icom Spain S.L

Ctra. Rubi, No. 88 Bajos A 08174, Sant Cugat del Valles, Barcelona, Spain  
Phone : +34 (93) 590 26 70 Fax : +34 (93) 589 04 46  
URL : <http://www.icomspain.com>  
E-mail : [icom@icomspain.com](mailto:icom@icomspain.com)

### Icom (UK) Ltd.

Unit 9, Sea St., Herne Bay, Kent, CT6 8LD, U.K.  
Phone : +44 (01227) 741741 Fax : +44 (01227) 741742  
URL : <http://www.icomuk.co.uk>  
E-mail : [info@icomuk.co.uk](mailto:info@icomuk.co.uk)

### Icom France s.a.s.

Zac de la Plaine  
1 Rue Brindejonc des Moulinais BP 5804  
31505 Toulouse Cedex, France  
Phone : +33 (5) 61 36 03 03 Fax : +33 (5) 61 36 03 00  
URL : <http://www.icom-france.com>  
E-mail : [icom@icom-france.com](mailto:icom@icom-france.com)

### Asia Icom Inc.

6F No.68, Sec. 1 Cheng-Teh Road, Taipei, Taiwan, R.O.C.  
Phone : +886 (02) 2559 1899 Fax : +886 (02) 2559 1874  
URL : <http://www.asia-icom.com>  
E-mail : [sales@asia-icom.com](mailto:sales@asia-icom.com)

### Icom Polska

81-850 Sopot, ul. 3 Maja 54, Poland  
Phone : +48 (58) 550 7135 Fax : +48 (58) 551 0484  
E-mail : [icompolska@icompolska.com.pl](mailto:icompolska@icompolska.com.pl)

**Count on us!**

**Icom Inc.**

1-1-32, Kamiminami, Hirano-ku, Osaka 547-0003, Japan

S-14232HZ-C1  
© 2006 Icom Inc.